

Kaleido-Solo (KS-900/KS-910) 3G/HD/SD SDI to HDMI Converter Guide to Installation and Operation

M865-9900-305

September 20, 2011



Miranda
Technologies Inc.
3499 Douglas-B.-Floreni
St-Laurent, Québec, Canada H4S 2C6

Tel. 514-333-1772
Fax. 514-333-9828
www.miranda.com

© 2011 Miranda Technologies Inc.

Safety Compliance

The power supply of this equipment complies with the following standards:

- UL 60950-1, 1st Edition, Safety for information technology equipment.
- CSA C22.2 No. 60950-1-03, 1st Edition, Safety for information technology equipment.



Electromagnetic Compatibility

This equipment has been tested for verification of compliance with FCC Part 15, Subpart B requirements for Class A digital devices.



NOTE: This equipment has been tested and found to comply with the limits for a Class A digital device, pursuant to part 15 of the FCC Rules. These limits are designed to provide reasonable protection against harmful interference when the equipment is operated in a commercial environment. This equipment generates, uses, and can radiate radio frequency energy and, if not installed and used in accordance with the instruction manual, may cause harmful interference to radio communications. Operation of this equipment in a residential area is likely to cause harmful interference in which case the user will be required to correct the interference at his own expense.

CE This equipment has been tested and found to comply with the requirements of the EMC directive 2004/108/CE:

- EN 55022 Class A radiated and conducted emissions
- EN 61000-4-2 Electrostatic discharge immunity
- EN 61000-4-3 Radiated electromagnetic field immunity – RF
- EN 61000-4-8 Power frequency magnetic field immunity
- EN 61000-4-11 Voltage dips, short-interruption and voltage variation immunity
- ENV 50204 Radiated EMF Immunity – RF 900 MHz pulsed

How to contact us:

For technical assistance, please contact the Miranda Technical support centre nearest you:

Americas

Telephone:

+1-800-224-7882

e-mail:

support@miranda.com

Asia

Telephone:

+852-2539-6987

e-mail:

asiatech@miranda.com

Europe, Middle East, Africa, UK

Telephone:

+44 (0) 1491 820222

e-mail:

eurotech@miranda.com

China

Telephone:

+86-10-5873-1814

e-mail:

asiatech@miranda.com

France (only)

Telephone:

+33 (0) 1 55 86 87 88

e-mail:

eurotech@miranda.com

Visit our web site at www.miranda.com

Table of Contents

1. Kaleido-Solo 3G/HD/SD Video to HDMI Converter	1
1.1 Introduction	1
1.2 Key features and benefits	2
1.3 Block Diagram.....	3
1.4 Output example.....	3
2 Installation.....	4
2.1 Unpacking	4
2.2 Connector Panel	5
2.3 RS-422/GPI connections	6
2.4 Powering up	6
3 Operating Controls and Functions	7
3.1 Special button functions.....	8
3.2 Status LED	8
4 Behavior	9
4.1 Video	9
4.1.1 Supported input resolution	9
4.1.2 Supported output resolution.....	10
4.1.3 Supported frame rate processing	10
4.1.4 Scaling limitations	11
4.1.5 Processing delay.....	11
4.2 Audio.....	11
5 Configuration (Menu).....	12
5.1 Status Menu	14
5.2 Video Menu	16
5.3 Metadata Menu	20
5.4 Audio Menu	22
5.4.1 Audio - General.....	23
5.4.2 Audio - 5.1.....	25
5.4.3 Audio - ALM	26
5.4.4 Audio - Downmix.....	27
5.4.5 Audio - Loudness	32
5.4.6 Audio - Loudness Advanced.....	34
5.4.7 Audio - Loudness Control	37
5.5 On Screen Display (OSD) Menu.....	38
5.5.1 OSD - General	38
5.5.2 OSD - Loudness	40
5.5.3 OSD - ALM.....	44
5.5.4 OSD - Timecode	49
5.5.5 OSD - Asp. Ratio.....	50
5.5.6 OSD - In. Format.....	51
5.5.7 OSD - Markers	52
5.5.8 OSD - UMD	54
5.5.9 OSD - SubTitle.....	55
5.6 Ethernet.....	56

5.7	Presets.....	58
5.8	General - Remote	59
5.9	General - GPI	60
5.10	About Menu	62
5.11	Safe Mode	63
6	XML Gateway	65
7	Upgrade Procedure	66
7.1	Using a crossover RJ45	66
7.1.1	How to determined the computer (windows 7) IP address.....	67
7.1.2	How to change the computer (windows 7) IP address	69
7.2	Connecting to your Kaleido-Solo (LAN connection or crossover connection)	71
8	Profile	74
9	Debug information.....	75
10	Custom resolution	76
11	Technical support information	77
12	Kaleido remote control (optional).....	78
13	Specifications	79
14	Annex 1: Glossary	80
15	Annex 2: AFD Functions	81
16	Annex 3: Installing the Optical Interface.....	85
17	Annex 4: SFP module and description.....	87
18	Annex 5: Mounting bracket.....	88

1. Kaleido-Solo 3G/HD/SD Video to HDMI Converter

1.1 Introduction

Kaleido-Solo is a compact, standalone 3Gbps/HD/SD video to HDMI converter, which allows low cost LCD displays to be used for video and loudness/dialnorm monitoring. It's ideal for many professional monitoring applications, including production, mobile truck, post-production and broadcast.

The converter allows operators to monitor loudness and dialnorm levels accurately over time, using a history graph overlay, without the cost and complexity of a traditional loudness monitoring device. Kaleido-Solo also provides overlays for markers, Time Code, subtitling, dynamic UMD (Under Monitor Display), Tallies, GPIO, AFD and ALM (Audio Level Meters). To simplify embedded audio monitoring, it provides two audio connectors to output S/PDIF and analog stereo of a 5.1 downmix, or any audio pair.

Kaleido-Solo provides automatic video input format detection, and supports a wide variety of video resolutions, including 525i, 625i, 720p, 1080i and 1080p.

Kaleido-Solo is available in two versions: KS-900 and KS-910. These two versions are identical except that the KS-900 does not offer loudness and dialnorm monitoring.



1.2 Key features and benefits

- 3Gbps/HD/SD to HDMI converter for video and audio monitoring
- Offers high quality and rich monitoring using a low-cost LCD panel
- Dual program loudness and dialnorm monitoring over time (KS-910 only)
 - Bigger loudness chart presentation **NEW!**
- ATSC A/85 and EBU R128 loudness measurement modes (KS-910 only)
- Automatic input format detection
- Supports 525i, 625i, 720p, 1080i and 1080p video resolutions
- Multi frame rate support including 23.98p/PsF, 24p/PsF, 25p/PsF, 50i, 50p, 59.94i and 59.94p
- Built-in scaler/de-interlacer
- Optical SFP fiber input/output options
- S/PDIF digital audio terminal that can output either:
 - a 5.1 Downmix
 - any PCM stereo pair
 - an incoming Dolby Digital stream
- Analog audio terminal that can output either:
 - a 5.1 Downmix
 - any PCM stereo pair
- Selectable burn-in and Metadata overlay:
 - History graph of audio loudness levels and dialnorm
 - ALM (Audio Level Meters)
 - Time Code
 - AFD/WSS/VLI
 - Aspect ratio markers
 - Dynamic UMD (Under Monitor Display) and Tallies **NEW!**
 - Subtitling (608,708,Teletext, OP-47) **NEW!**
- Configurable presets **NEW!**
- Configurable general purpose input/output (GPIO) **NEW!**
- Automatic aspect ratio support **NEW!**
- Video scaling and positioning options **NEW!**
- HDMI 5.1 audio support **NEW!**
- Easy configuration using on-screen menus
- Failsafe mechanism for unsupported monitor resolutions
- Convenient mounting bracket included
- Optional remote control for menu navigation and configurable buttons **NEW!**

1.3 Block Diagram

The following block diagram shows the functionality of the Kaleido-Solo.

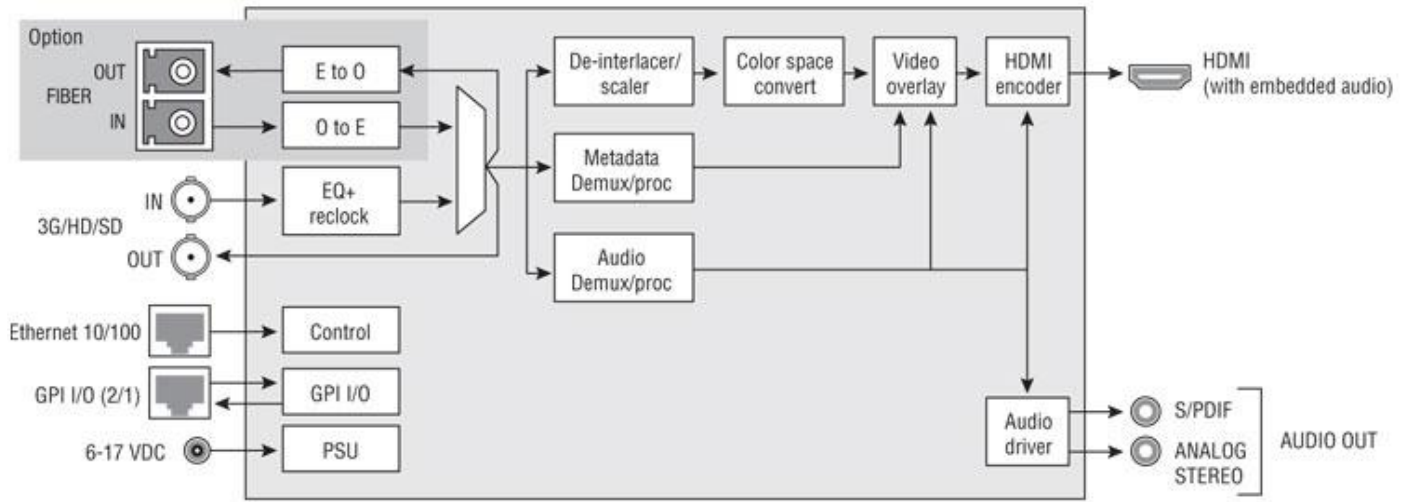

Figure 1 - Functional Block Diagram

1.4 Output example



Figure 2 - Elements of the on-screen display

2 Installation

2.1 Unpacking

Make sure the following items have been shipped with your Kaleido-Solo. If any of the following items are missing, contact your distributor or Miranda Technologies Inc.

- Kaleido-Solo
- Power Supply
- Power cord
- User Manual
- Special mounting adapter with Kaleido-Solo mounting screws (see section 18)
- 4x square velcro
- Warranty and Support Contact

2.2 Connector Panel

The rear connector panel incorporates all inputs and outputs associated with the Kaleido-Solo, with the exception of a Remote Control connector (sold separately) on the front panel.



Connections			
#	Label	Signal	Connector type
1	Fiber OUT/IN		SFP module
2	3G/HD/SD IN	SDI input	BNC
3	3G/HD/SD OUT	SDI output	BNC
4	S/PDIF Audio Out	S/PDIF digital 2 ch.	3.5mm stereo jack
5	ANALOG Audio Out	2 channels unbalanced	3.5mm stereo jack
6	Monitor Out	HDMI to monitor	HDMI type A
7	Ethernet 10/100		RJ-45
8	RS-422 / GPI		RJ-45
9	Power		

The two video outputs (fiber and electric) are not loop-throughs of their respective inputs. They both carry the video from the selected input of the Kaleido-Solo. In this sense, the Kaleido-Solo functions as an optical/electric or electric/optical converter.

2.3 RS-422/GPI connections

RS422/GPI Connector	
Pin number	Description
#1	RS-422 Tx+
#2	RS-422 Tx-
#3	RS-422 Rx+
#4	GPI Input #1
#5	GPI Input #2
#6	RS-422 Rx-
#7	GPI Output
#8	Ground

2.4 Powering up

When powering up the Kaleido-Solo

- The led should turn on red.
- After 5 seconds the led should flash red (no valid SDI input) or green (valid SDI input).
- Your monitor should turn on and you should see content of the SDI input. If you only use the optional optical input you won't be able to see any video until 15 seconds approximately. In this step Kaleido-Solo will use all factory default parameters for video and audio. Even if you had muted audio you will hear audio in this boot up step.
- After 15 seconds the led should stop blinking.
- The overlay should appear making the monitor turn off and on once.
- You are now ready to use the Kaleido-Solo.

The average total time to power-up a Kaleido-Solo is 20 seconds.







Note that the screen may turn off and on more than once on some monitor. This is a normal behavior.

3 Operating Controls and Functions

The Kaleido-Solo is configured and operated using the four buttons on the front panel to navigate through on-screen menus displayed on the video monitor. There are also some non-menu functions for these buttons.







From left to right:

#	Label	Description
1		Reset button
2	Status	Status LED
3	Remote control	Connection with the optional Kaleido-Solo remote control see section 12
4		Escape
5		Up
6		Down
7		Enter



Note that you can see 2 mounting holes on the right side to mount the included metal bracket - see section 18.

3.1 Special button functions

Label	Description
<i>Reset button</i>	Press to reset unit Hold for 5 seconds to restore factory default
 + 	Hold for 5 seconds to enter safe mode (640x480)
 <i>or</i> 	Analog audio volume control (when not in menu)

3.2 Status LED

The status LED in the lower left corner of the front panel displays the current status of the Kaleido-Solo.

Status	Description
<i>Green</i>	Video presence on selected input with no errors
<i>Flashing green</i>	Kaleido-Solo is still booting up with a valid video input
<i>Red</i>	No signal Signal with errors Unstable input signal Hardware failure (after boot up)
<i>Flashing red</i>	Kaleido-Solo is still booting up with an invalid video input.

4 Behavior

4.1 Video

4.1.1 Supported input resolution

<i>Format</i>	<i>Kaleido representation (status menu)</i>
525i 59.94	525
625i 50	625
1280x720p 60	720p 60Hz
1280x720p 59.94	720p 59.94Hz
1280x720p 50	720p 50Hz
1920x1080i 60	1080i 60Hz
1920x1080i 59.94	1080i 59.94Hz
1920x1080i 50	1080i 50Hz
1920x1080p 60	1080p 60Hz
1920x1080p 59.94	1080p 59.94Hz
1920x1080p 24	1080p 24Hz
1920x1080p 23.98	1080p 23.98Hz
1920x1080p 50	1080p 50Hz
1920x1080p 25	1080p 25Hz
1920x1080 PsF 24	1080p 24sF
1920x1080 PsF 23.98	1080p 23.98sF
1920x1080 PsF 25	1080i 50Hz

4.1.2 Supported output resolution

Format	Kaleido representation (status menu)
1920x1200p 60/59.94/50	e.g.: 1920x1200p60
1920x1080p 60/59.94/50	e.g.: 1920x1080p60
1600x1200p 60/59.94/50	e.g. : 1600x1200p60
1680x1050p 60/59.94/50	e.g. : 1680x1050p60
1440x900p 60/59.94/50	e.g. : 1440x900p60
1366x768p 60/59.94/50	e.g.: 1366x768p60
1280x720p 60/59.94/50	e.g.: 1280x720p60
640x480p 60/59.94	e.g.: 640x480p60



Note that 640x480p 60 is the safe mode resolution.



Note that other resolutions can be supported though safe mode menu see section 5.11.

4.1.3 Supported frame rate processing

Frame rate input	60Hz monitor	50Hz monitor
60/59.94/30/29.97/24/23.98	✔	
50/25	✔	✔

Here is some example of frame rate conversion (the scaling processing has been omitted for brevity):

Input	Processing	Output
1280x720p 59.94	No processing	1920x1200p 59.94
1920x1080i 60	Deinterlaced Frame doubling	1920x1200p 60
625i 50	Deinterlaced Frame doubling	1920x1200p50
625i 50	Deinterlaced Frame repetition	1920x1200p60
1920x1080p24	Frame repetition (3:2 insertion)	1920x1200p60
1920x1080i50 (50i/PsF should be set to interlaced)	Deinterlaced Frame doubling	1920x1200p50
1920x1080 PsF 25 (50i/PsF should be set to PsF)	Field merge Frame doubling	1920x1200p50

4.1.4 Scaling limitations

When scaling an SD 4:3 input (e.g.: AFD Code: 4:3_8) to a 1920x1200 monitor the output image will not fill the monitor as it should. The aspect ratio is still maintained.

When scaling an SD letter box input (e.g.: AFD Code: 4:3_4) into a 1920x1200 or 1920x1080 monitor the output image will not fill the monitor as it should. The aspect ratio is still maintained.

4.1.5 Processing delay

The Kaleido-Solo's video processing delay is about 1 frame when the input frame rate is equal to half of the output rate (e.g.: i60 to p60). In all other cases the processing delay is kept at its minimum.

4.2 Audio

Kaleido-Solo doesn't decode compressed audio. Selected compressed audio will be passed through HDMI and SPDIF interfaces unprocessed.



Note that the monitor must support compressed audio if you pass compressed audio on the hdmi output.

5 Configuration (Menu)

To open the menu system, press **ENTER**.

The menu display will open in the center of the screen.

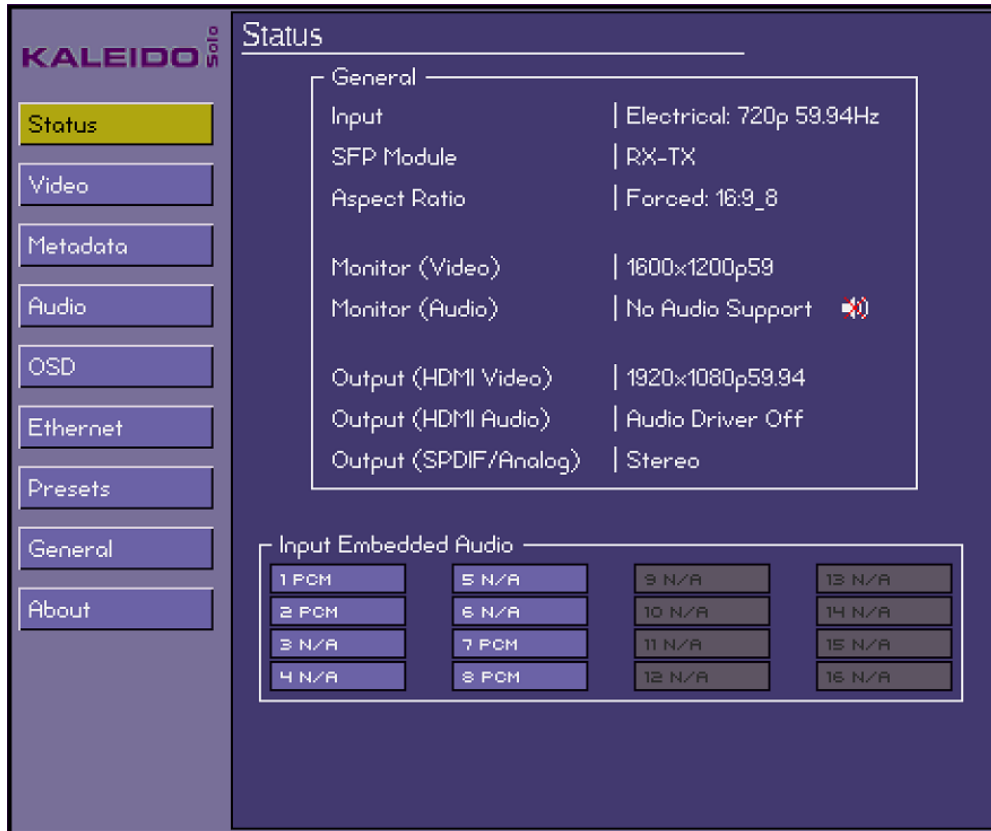

The current position always appears to the right and it is highlighted in yellow along with the path to it..

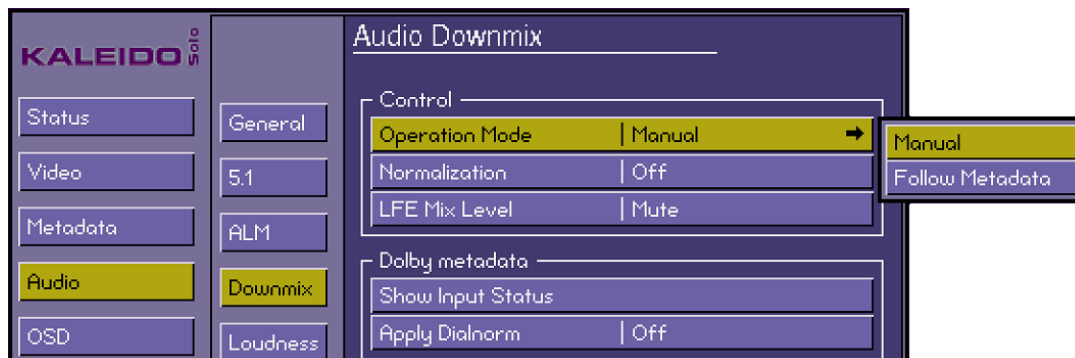

- Move up and down the options in the current level by using the **UP** and **DOWN** buttons
- Move back to the previous level on the left by pushing the **ESCAPE** button
- Move on to the next level, which will appear on the right, by pushing the **ENTER** button.

The right-most level will usually allow a value or option to be selected. It will be a list of choices, or perhaps a sliding scale.

- When you enter that level, the current value will be shown
- Select a different value using the **UP** and **DOWN** buttons, then:

Either..... Push **ENTER** to acknowledge the value and move back to the previous menu level.

Or..... Push **ESCAPE** to move back to the previous menu level while restoring the value to its original state.

When you have finished using the menu, push **ESCAPE** until you are in the left-most level, and then once more. The menu will disappear from the screen.

Kaleido-Solo remembers the last path you used, so you can retrace your steps back to the last parameter changed quickly, just by pushing **ENTER** until you arrive at the value list.

All parameters are saved automatically 5 seconds after the last change. Be sure to not unplug the Kaleido-Solo within this 5 seconds or you may lose your modifications.



Note that these 5 seconds also apply when you reverse a change using the **ESCAPE** key.

5.1 Status Menu

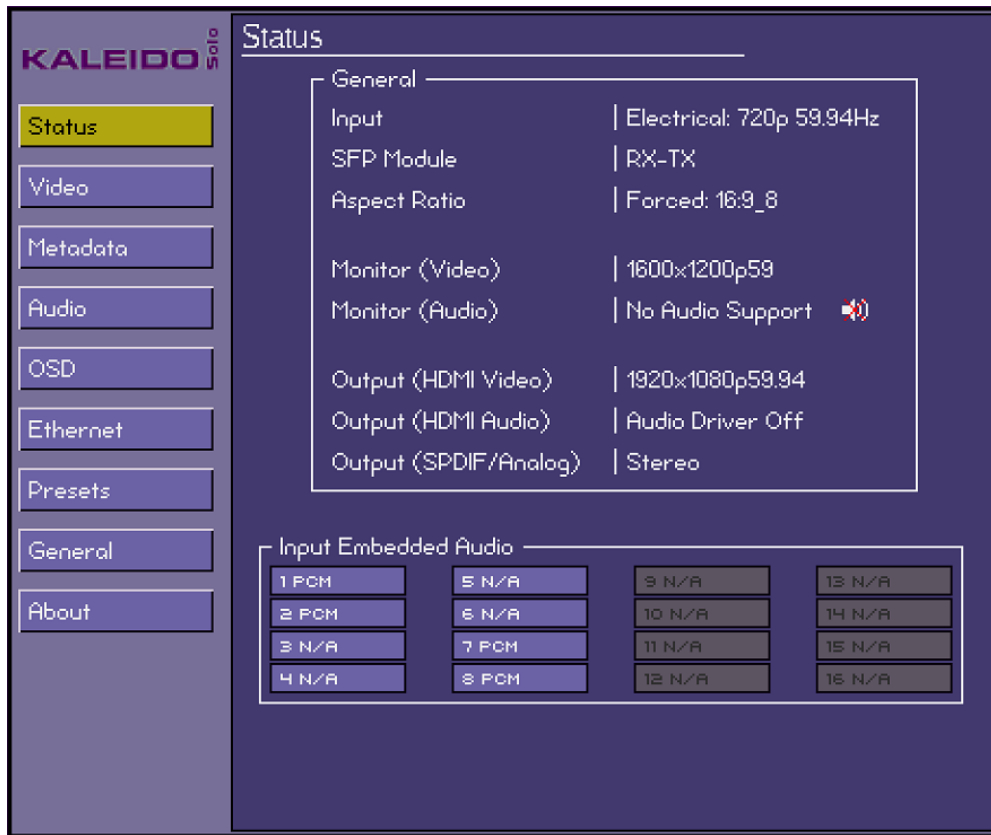

Category		Description
<i>General</i>	Input	Shows the selected input Electrical (BNC) / Optical (SFP module). Shows the format detected as specified in section 4.1.1.
	SFP Module	Shows the type of external module detected and supported (None, Dual TX, Dual RX, RX, TX or RX-TX) see Annex 4: SFP module and description.
	Aspect Ratio	Shows the AFD/VLI/WSS aspect ratio video processing applied at the output. This parameter can be changed in the Metadata section.
	Monitor (Video)	Shows the monitor's preferred resolution specified by EDID see section 5.11. See section 4.1.1 for possibilities.
	Monitor (Audio)	Shows the monitor audio support status specified by EDID see section 5.11. Possibilities are: No Audio Support, Linear PCM, AC-3, MPEG1 ,MP3 ,MPEG2, AAC, DTS, ATRAC, One Bit Audio, Dolby Digital+, DTS-HD, MAT (MLP), DST, WMA Pro, Format Unknown.

	Output (HDMI Video)	Shows the actual output resolution at the HDMI output. See section 4.1.1 for possibilities.
	Output (HDMI Audio)	Shows the actual audio state at the HDMI output. Possibilities are: Audio Driver Off (DVI Mode), Stereo (HDMI Mode), 5.1 (HDMI Mode). Possibilities are: Stereo, 5.1 no.1 Downmixed, 5.1 no.2 Downmixed, 5.1 no.1, 5.1 no.1. Muted (NPCM), 5.1 no.2, 5.1 no.2 Muted (NPCM), Audio Driver Off, Muted
	Output (SPDIF/Analog)	Shows the current state of the SPDIF/Analog audio output. Possibilities are: Stereo, 5.1 no.1 Downmixed, 5.1 no.2 Downmixed, 5.1 no.1 Muted (NPCM), 5.1 no.2 Muted (NPCM), Muted.
<i>Input Embedded Audio</i>	1 to 16	Shows the type of audio detected per channel (PCM, NPCM, AC3, E-AC3, DOLBY E, MPG1L1, MPG1L2/3, MPG2 aud, MPG2L1, MPG2L2/3, AAC, HE-AAC, or N/A).

The Monitor resolution can be different than the Output resolution. In most cases both resolution will be the same.

5.2 Video Menu



Input Selection

Select the input signal to be used by the Kaleido-Solo. Choose between:

<i>Electrical:</i>	The signal arriving on the rear-panel BNC connector.
<i>Optical:</i>	The signal arriving via optical fiber into the SFP module installed in the rear panel.

Video Picture

<i>Checked</i>	Enable the input video to appear on screen.
<i>Unchecked</i>	Disable the input video and subtitling from appearing on screen.

Scaler

<i>Auto:</i>	The scaler uses the output resolution and aspect ratio (automatic or forced) to maximize video size. The input signal is de-interlaced (when input is interlaced) and then scaled for the display.
<i>5% to 65%</i>	Scale down the video to a specific image size. 5% will produce a smaller image than 65%.
<i>Off:</i>	The incoming video is not rescaled. If it is smaller than the display, it will appear centered within the display. If it is larger than the display, the video will be centered but cropped so that only a part of it is shown. In this mode the video will not react to the aspect ratio configuration.

Picture anchor

When the scaler is not in Auto or Off you can select up to 9 pre-configured video position.

Picture offset

When the scaler is not in Auto or Off you can fine tune the video horizontal and vertical position.

Dynamic Range

SDI video has a dynamic range from 16 for black to 235 for white. Dynamic range expansion broadens the range to the full gamut of 0 to 255 that is available in an 8-bit system.

<i>Expand:</i>	Use the full dynamic range of 0 to 255 for the displayed video by expanding the input video data (video processing implied). Video values lower than 16 will be clipped to 0.
<i>Standard:</i>	Display the video using the standard dynamic range of 16 to 235. Video values lower than 16 will be displayed properly.

50Hz i/PsF

When the input signal is 1080i 50 Hz, it is not possible to automatically detect whether the video is 25 Hz PsF video or 50 Hz interlaced. If PsF is known to be present it must be manually selected, so that the Kaleido-Solo can properly process the video image (de-interlacing for interlaced video; field-merging for PsF video).

<i>Interlaced:</i>	Use when the input video is in interlaced format. The video will be de-interlaced.
<i>PsF:</i>	Use when the input video is in PsF format. The video will be field-merged.

Test Pattern

The user can replace the displayed video with a test signal (a valid video input must be present).

Select from these choices:

<i>Off:</i>	The input video appears at the output.
<i>Color Bars:</i>	Sends a 75% color bar test pattern (100% white), along with audio test tones (a continuous tone on right channel with pulsed tone on left channel in every pair) to the Kaleido-Solo output.

<i>Lip-sync:</i>	Sends a special test signal comprising color bars and tone plus a visual element that is used to align audio-video delays in a processing path.
------------------	---

The special test signal consists of 75% color bars within which a white square is inserted every 4 seconds for a duration of 10 frames. Simultaneously with the beginning of the first field of video containing the white square, the audio channels at the output are pulsed with a tone lasting 250 ms.

Viewing the video display and listening to the audio allows the user to time-align the audio and video for correct lip-sync. Go to the **Audio - General - Delay (SPDIF/Analog)** menu (see section 5.4.1) to make the timing adjustment.

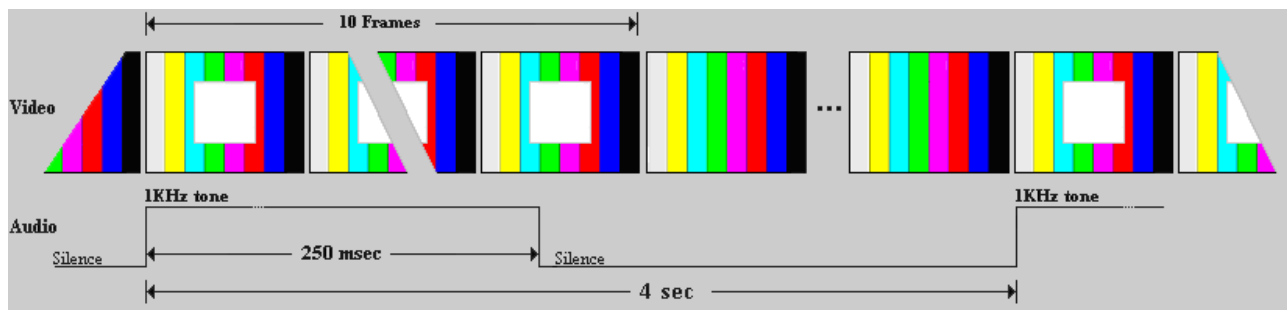

! Note that these test signals are available only when there is an input to the Kaleido-Solo, and they only appear on the HDMI and audio outputs; they do not appear on the BNC and optical outputs.

! Note that activating the test pattern will override all audio parameters e.g.: output volume and disable some OSD elements e.g.: audio level meters.

Aspect Ratio - Mode

<i>Follow Metadata:</i>	Selects the code extracted from the input signal and process (scale) the video accordingly. If there is no aspect ratio code Forced mode code will be used.
<i>Forced:</i>	Selects the Forced HD selection (e.g.: 16:9_8) when an HD signal is present or the FORCED SD selection (e.g.: 4:3_8) to process (scale) the video accordingly.

! Note that a 1 frame time reaction can be noticed when there is an aspect code change if follow metadata is selected.

Aspect Ratio - Forced HD

Select the AFD code that will be forced for an HD input video signals when scaler is set to anything but Off.

Refer to: Annex 2: AFD Functions

16:9_2
16:9_3
...
16:9_14
16:9_15

Aspect Ratio - Forced SD

Select the AFD code that will be forced on the for an SD input video signals when scaler is set to anything but Off.

Refer to: Annex 2: AFD Functions

4:3_2
4:3_3
..
4:3_14
4:3_15
16:9_8 (*Anamorphic*)

5.3 Metadata Menu

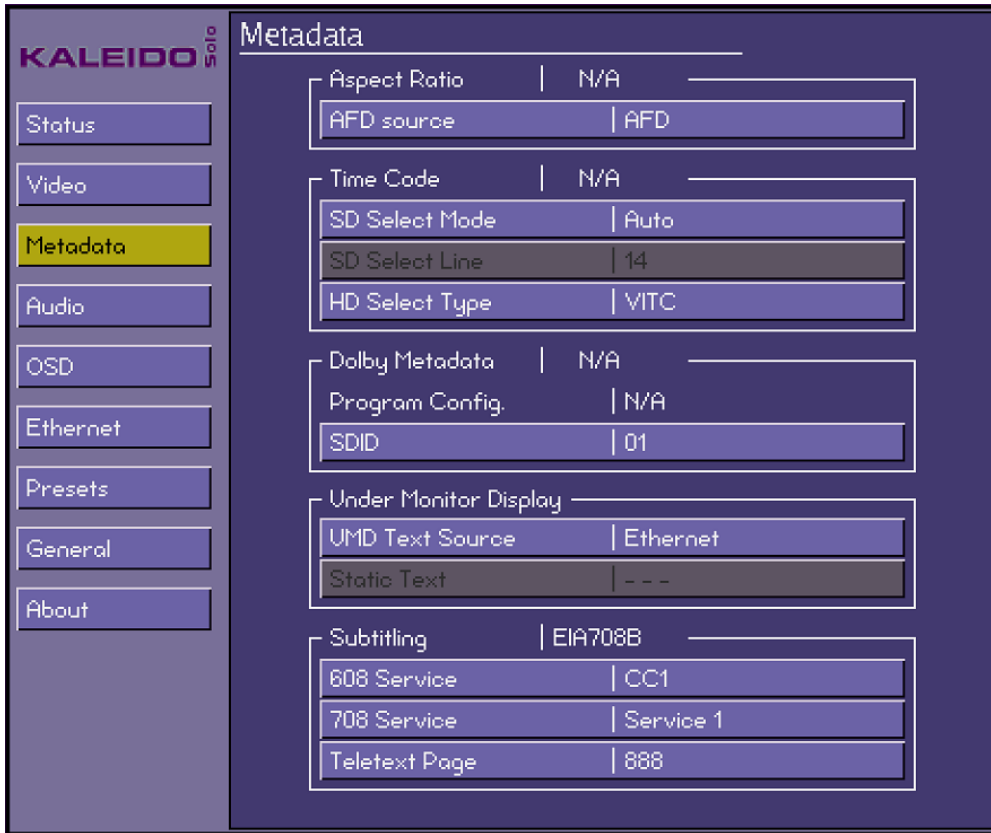

This menu is used to configure the parameters needed to correctly extract different metadata types - for example, the aspect ratio source, time code packet, the Dolby metadata packet, etc.

Status

Some statuses are reported directly in this menu for the ease of configuration.

<i>Aspect Ratio Status:</i>	Aspect ratio status shows the presence of an AFD code of the type specified by the AFD source parameter (Detected or N/A).
<i>Time Code Status:</i>	Time code status shows the presence of time code (Detected or N/A).
<i>Dolby Metadata Status:</i>	Dolby metadata shows the presence of the selected SDID (Detected or N/A).
<i>Subtitling Status:</i>	Subtitling status shows the presence and type of subtitling (CC608, EIA708B or Teletext)

Aspect ratio - AFD source

Select the source of the metadata that will be used by this Kaleido-Solo for aspect ratio control:

<i>AFD:</i>	Selects AFD (SMPTE 2016) as the source for HD and SD (525, 625) aspect ratio descriptor.
<i>VLI:</i>	Selects VLI as the source for the SD (525, 625) aspect ratio descriptor.
<i>WSS:</i>	Selects WSS as the source for the SD (625) aspect ratio descriptor.

The Active Format Descriptor (AFD) flag is used to identify the aspect ratio and protected areas of a video signal.

The AFD flag is implemented differently in HD and SD:

- In HD, the AFD flag (SMPTE 2016) is sent as an ancillary packet, normally found on line 11 in the vertical ancillary space.
- In SD, the AFD flag is sent as a Video Line Index (VLI) signal (RP 186), as a Wide Screen Signaling (WSS) signal (ITU-R BT.1119-2) for 625 only, or as an AFD packet (SMPTE 2016).



Note that it is not possible to specify different sources for SD and HD, e.g.: VLI for SD and AFD for HD.

Time Code - SD Select Mode

Select whether time code extraction from SD video inputs will be automatic or manual.

<i>Auto:</i>	The vertical interval of the incoming video is scanned and the first detected time code is extracted.
<i>Manual:</i>	Time code will only be extracted if it appears on a specified line in the vertical interval.

In Manual mode only, the SD Select Line menu item is enabled, allowing the line number for extraction to be specified.

Time Code - HD Select Type

Select the source of the timecode to be displayed when the input video is HD.

<i>VITC:</i>	Use ATC VITC time code (time code updated every field).
<i>LTC:</i>	Use ATC LTC time code (time code updated every frame).

Dolby Metadata – SDID

Specify which SDID to look at for Dolby Metadata extraction:

- 01
- 02
- ...
- 08
- 09

An SDI signal could contain up to 9 different Dolby metadata packets. This specifies which one to select. Some of the information contained in the selected packet could affect the behaviour of the loudness (see section 5.4.5) or downmix (see section 5.4.4).

5.4 Audio Menu

Audio output bloc diagram

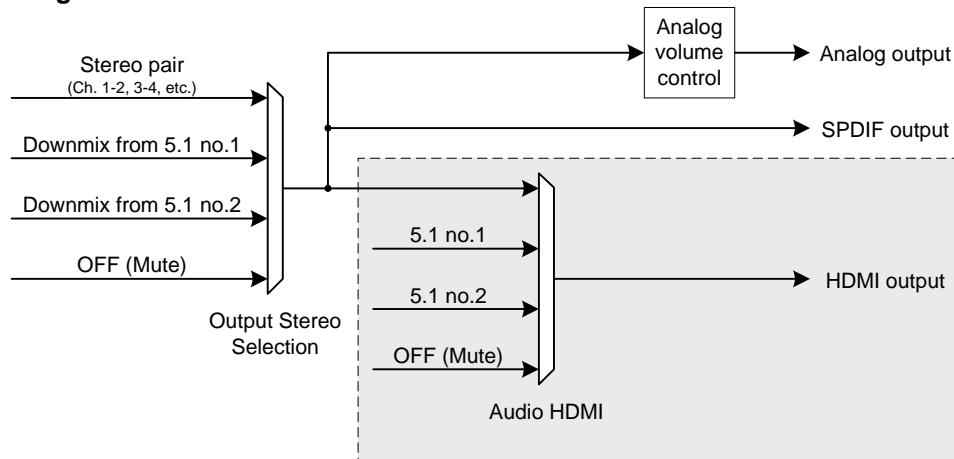

The audio HDMI selection is not available if the monitor does not support audio. The audio capability is reported by the monitor's EDID or described by configuring the monitor parameter in the safe mode menu or described in the custom resolution (see section 5.11)

When a NPCM audio is involved in a downmix selection the output stereo selection will be muted. Downmix channels selection are done in section 5.4.2.

When a NPCM audio is involved in a HDMI 5.1, all channels will be muted even the PCMs. 5.1. Channels selection are done in section 5.4.2.

To pass a compressed audio pair to the HDMI output, the audio stereo path must be use with the two channels involved. 5.1 only works for PCM audio.

All audio outputs are configured in section 5.4.1.

5.4.1 Audio - General



Output Stereo Selection

Select the audio channel pair that will be sent to the Kaleido-Solo outputs (HDMI, S/PDIF and analog) for monitoring.

<i>Ch. 1-2</i>	Monitor channel 1 (left) and 2 (right).
...	
<i>Ch. 15-16</i>	Monitor channel 15 (left) and 16 (right).
<i>Downmix 5.1 no. 1</i>	Monitor the downmix output. See section 5.4.2 to configure the input channels assignment of downmix no. 1. See section 5.4.4 to configure the downmix behavior.
<i>Downmix 5.1 no. 2</i>	Monitor the downmix output. See section 5.4.2 to configure the input channels assignment of downmix no. 2. See section 5.4.4 to configure the downmix behavior.
<i>OFF (MUTE)</i>	Turn off audio monitoring.

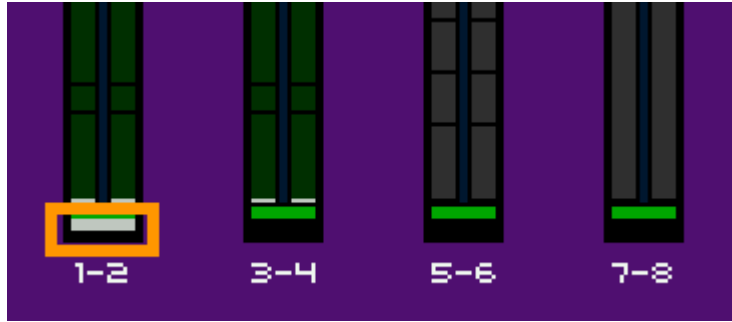

The OSD ALMs indicate which audio pair is being monitored. A grey marker at the bottom of the ALM shows the selected pair. In this example the audio pair 1-2 is selected. If downmix or off is selected no grey marker is present.

Audio HDMI

Choose whether to send the audio channels selected for monitoring to the HDMI port.

<i>Stereo</i>	Enable stereo audio insertion in HDMI. The selected stereo pair is selected by the Output Stereo Selection configuration.
<i>5.1 no.1</i>	Enable 5.1 audio insertion in HDMI. The selected channel are define in section 5.4.2.
<i>5.1 no.2</i>	Enable 5.1 audio insertion in HDMI. The selected channel are define in section 5.4.2.
<i>Off</i>	Disable audio insertion in HDMI (this could help with some monitors that does not support compressed audio).

Volume (Analog)

Adjust the volume of the Kaleido-Solo's analog audio output.

<i>0 dB</i>	The input level is unchanged.
<i>...</i>	
<i>-96 dB</i>	The input level is attenuated.



Note that the audio output volume can also be adjusted by pressing the **UP** and **DOWN** keys when you are in normal operation (i.e. menu not displayed).

Delay (SPDIF/Analog)

Delay can be added to the SPDIF and analog audio outputs, to compensate for a monitor video delay, so that the audio timing can be matched to the video for lip sync. This control does not affect the audio inserted in the HDMI port.

Using the lip sync test signal (see section 5.2) will help when making this adjustment.

From the *Delay (SPDIF/Analog)* menu, press **ENTER**. The main menu disappears and only the adjustment slider remains visible. This ensures that the test signal or video that is being used to adjust the audio delay is not obscured by the menu.

Use the **UP** and **DOWN** buttons to adjust the audio delay until the timing is subjectively correct, then press **ESCAPE** to go back to the Audio General menu.

The available delay range is 0 to 120 ms.

5.4.2 Audio - 5.1

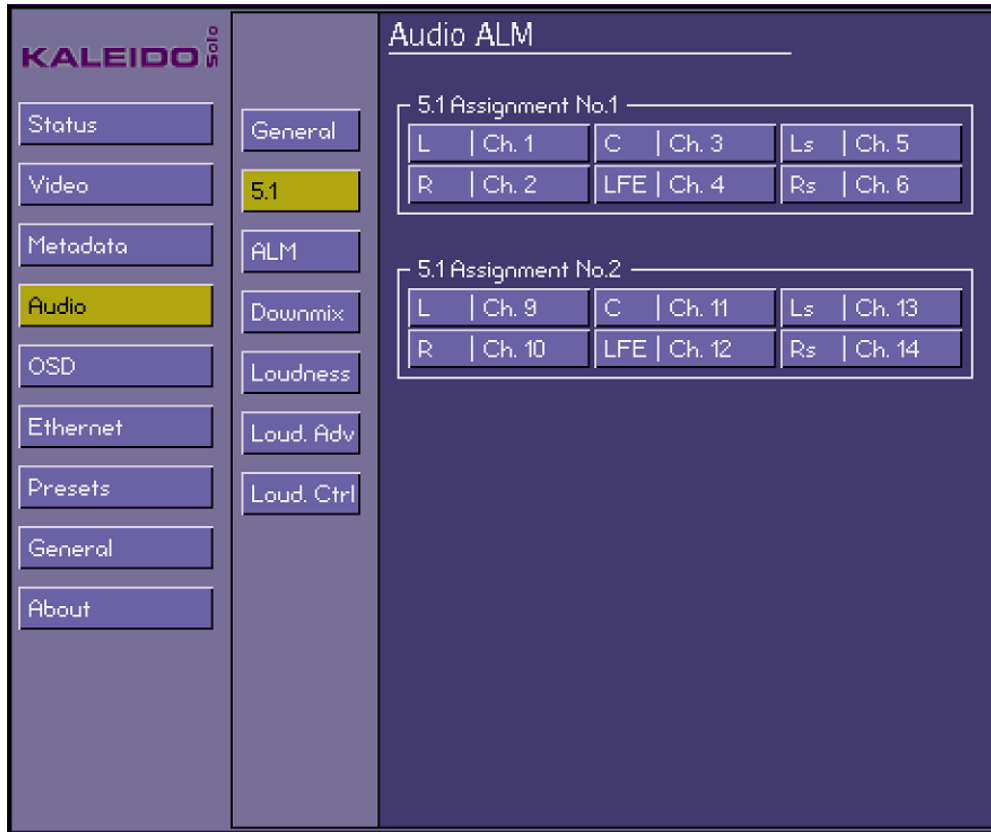

5.1 Assignment No.1

Select the channels you want to assign to 5.1 no.1. This assignment will be use by ALMs, downmix, HDMI 5.1 no. 1 audio selection, etc.

5.1 Assignment No.2

Select the channels you want to assign to 5.1 no.2. This assignment will be use by ALMs, downmix, HDMI 5.1 no. 2 audio selection, etc.

5.4.3 Audio - ALM

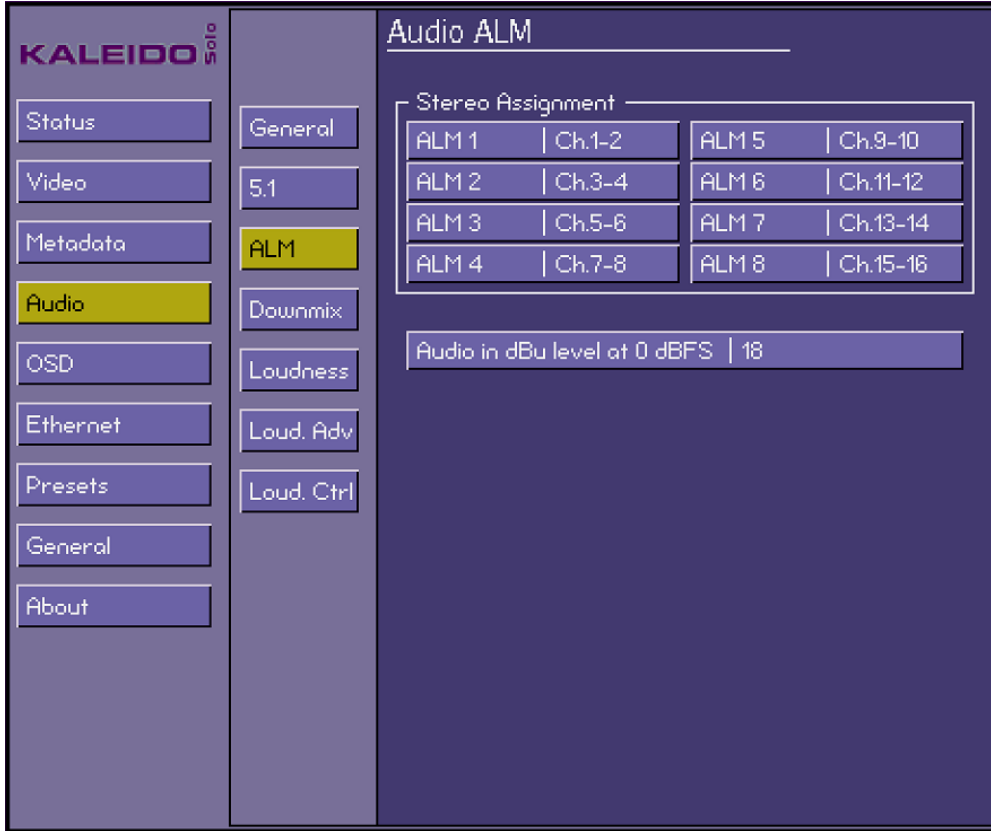

Stereo Assignment

Select input channels (by pair) for each of the eight available ALMs. To change the visual aspect of ALMs see section 5.5.3.

Audio in dBu level at 0 dBFS

This configuration is used when using analog level meters (listed below). Furthermore, it's the reference level used to convert dBFS to dBu.

Analog level meters affected by this parameter:

- VU METER (IEC60268-17) Analog VU
- UK PPM (IEC60268-10 type IIa) Analog peak
- EBU PPM (IEC60268-10 type IIb) Analog peak
- NORDIC PPM (IEC60268-10 type I) Analog peak
- DIN PPM (IEC60268-10) Analog peak

5.4.4 Audio - Downmix



The Kaleido-Solo provides two channels of audio output. If the input audio is a 5.1 surround sound signal, it must be downmixed for monitoring. This menu provides the configuration for the downmix.

Control - Operation Mode

<i>Manual</i>	Choose this option if you want to manually configure the channels for the downmix (see audio -> downmix -> input selection).
<i>Follow Metada</i>	If you have properly configured the dolby metadata extraction (see section 5.3) you can use this option. It will configure the downmix using specific extracted parameters from program 1 (center mix level, surround mix level and mode (LtRt/LoRo)). If you also want to use the dialnorm extracted parameter you must set the “Apply Dialnorm” selection to ON. You can display the contents of the Dolby metadata using the Show Input Status.



Note that if there is no Dolby metadata and the operation mode is set to “follow metadata” the Kaleido-Solo will switch to manual mode automatically using entered manual settings for its processing. If Dolby metadata is detected again the Kaleido-Solo will switch back to follow metadata mode.

Control - Normalization

Select whether level and loudness normalization are applied to the downmix results

<i>Off</i>	Downmix output level is not normalized. Clipping may occur depending on the input channel levels and the selected mix levels.
<i>Level A (lvl)</i>	Downmix output level is normalized based on the applied mix levels to provide a uniform output over the range of mix levels available. Clipping will never occur, even with full scale input channels and mix levels.
<i>Level B (lvl+loud)</i>	Downmix output level is normalized based on the channel configuration to provide uniform output loudness between 3/2 and 2/0 programs. Downmixing a 3/2 program produces loudness attenuation compared to the same program in 2/0 at the same input loudness. To provide a uniform output loudness, a loudness attenuation is applied only on 2/0 programs. If the operating mode is Follow Metadata, the channel configuration is given by the AC-3 coding mode parameter in the metadata. If the operating mode is Manual, the channel configuration is given by the selected mix levels: a 2/0 channel configuration is achieved by setting Center, Surround, and LFE Mix Levels to Mute. Any other combination of mix levels is assumed to be a 3/2 channel configuration. Level-B normalization also includes Level-A normalization, based on the applied mix levels. Clipping will never occur, even with full scale input channels and mix levels.

Control - LFE Mix Level

Set the level of the contribution of the LFE channel to the downmixed signal.

<i>+10 dB</i> <i>+9 dB</i> <i>+7.5 dB</i> <i>+6 dB</i> <i>+4.5 dB</i> <i>+3 dB</i> <i>+1.5 dB</i>	The input level is boosted.
<i>0 dB</i>	The input level is unchanged.
<i>-1.5 dB</i> <i>-3 dB</i> <i>-4.5 dB</i> <i>-6 dB</i>	The input level is reduced.
<i>Mute</i>	LFE is not used in the downmix.

This gain is always applied to LFE even if the operation mode is set to follow metadata because there is no such information in the metadata.

Dolby Metadata - Show Status

Select Show Status and **ENTER** to see the contents of the Dolby Metadata that will control the downmix process in the *Follow Metadata* operating mode.

The *Dolby Status* information window opens, as shown in this example -

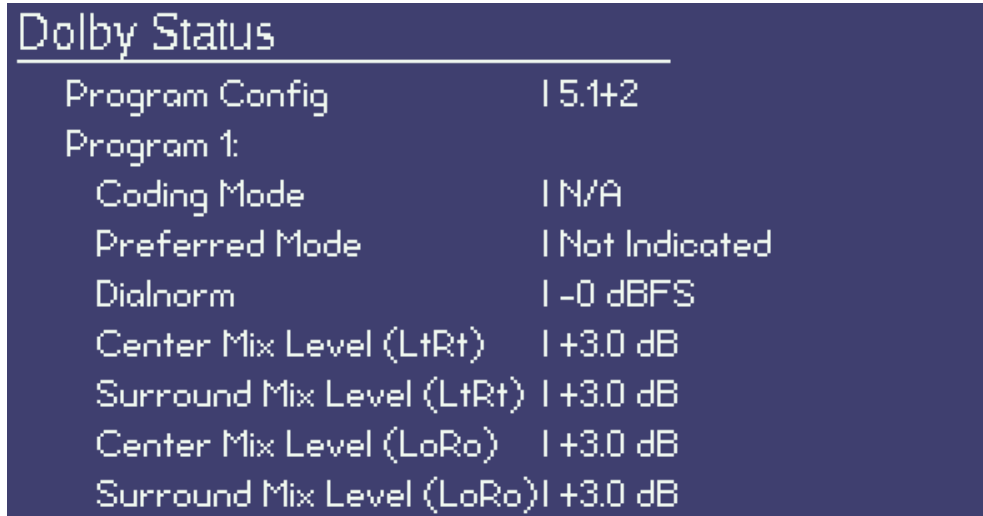

Press **ESCAPE** to close the information window and return to the menu.

Dolby Metadata - Apply Dialnorm

Choose whether to apply the Dialnorm parameter to the downmixed stereo program.

<i>On</i>	Applies a gain after the downmix. The gain applied is contained in the Dolby Metadata if the operation mode is set to follow metadata or set by the manual dialnorm if operation mode is set to manual. The -31 dBFS is equal to unity (no gain).
<i>Off</i>	No gain applied.

Manual – Mode

<i>LtRt</i>	Stands for Left total/Right total. It's a downmix suitable for decoding with a Dolby Pro Logic surround sound device.
<i>LoRo</i>	Stands for Left only/Right only. It's a downmix suitable for stereophonic sound playback.

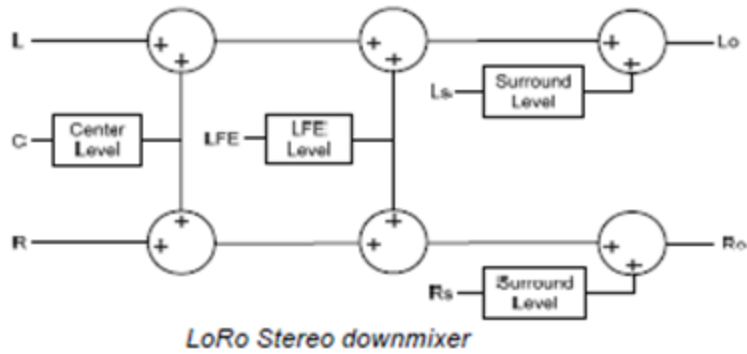
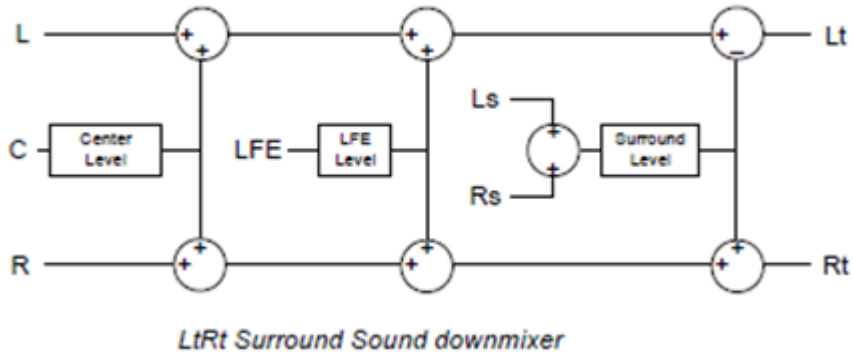

Manual - Dialnorm

Select a dialnorm value to use during the manual downmix. The gain will be applied after the downmix.

-1 dBFS	30 dB gain is applied.
...	
-31 dBFS	Unity gain is applied (no gain, no attenuation).

The gain applied (dBFS) is calculated as follow: Gain applied (dBFS) = 31 dBFS + Dialnorm

Manual - Center Mix Level

Select the mix level of the center channel into the stereo downmix.

+3 dB +1.5 dB	The input level is boosted.
0 dB	The input level is unchanged.
-1.5 dB -3 dB -4.5 dB -6 dB	The input level is reduced.
Mute	Center is not used in the downmix.

Manual - Surround Mix Level

Select the mix level of the surround channels into the stereo downmix.

+3 dB +1.5 dB	The input level is boosted.
0 dB	The input level is unchanged.
-1.5 dB -3 dB -4.5 dB -6 dB	The input level is reduced.
Mute	Surround is not used in the downmix.

Input Selection

Assign input channels to the L, R, C, LFE, Ls and Rs downmix inputs.



Note that if compressed audio is detected on one or more of the assigned channels, the downmix audio will be muted.

5.4.5 Audio - Loudness



Loudness measurement is available in Kaleido-Solo model **910** only.



The Kaleido-Solo supports two independent loudness measurements, called “1st Loudness” and “2nd Loudness”. You can configure both in this menu. Having two separate measurements is useful if, for example, you want to measure one 5.1 and one stereo pair simultaneously.

1st Loudness/2nd Loudness - Program Selection

<i>Manual</i>	Use to manually set the coding mode and the channel selection.
<i>Prog. 1</i>	Use the Dolby metadata contained coding mode and channel selection of program #1.
...	
<i>Prog. 8</i>	Use the Dolby metadata contained coding mode and channel selection of program #8.



Note that loudness meters can, under some conditions, be unable to display loudness information. For instance, if one of the loudness audio channels involved is not PCM, an error message will be displayed and no loudness data will be shown. The same thing will happen if the audio program selected (and its associated audio coding mode) is extracted from Dolby Metadata and none can be found on input. An error message saying “no Dolby” will show up to explain why no data is being processed.

1st Loudness/2nd Loudness – Manual Coding Mode

The manual coding mode offers a way to manually configure the loudness measurement. Changing the coding mode will enable or disable channel assignments. For example if you select 1/0 (c), only the center channel can be assigned and be considered in the loudness measurement.

Here is a list of available coding modes:

1/0 (C)
 1/0 (C) TO STEREO
 2/0 (L, R)
 3/0 (L, C, R)
 3.0L (L, C, R, LFE)
 2/1 (L, R, S)
 2/1L (L, R, S, LFE)
 3/1 (L, C, R, S)
 3/1L (L, C, R, S, LFE)
 2/2 (L, R, Ls, Rs)
 2/2L (L, R, Ls, Rs, LFE)
 3/2 (L, C, R, Ls, Rs)
 3/2L (L, C, R, Ls, Rs, LFE)



Note that the 1/0(C) TO STEREO selection will copy one channel (selectable) into a stereo pair for proper loudness measurement.

1st Loudness/2nd Loudness - Target Src (Dialnorm)

<i>Manual</i>	By selecting this option you can change the loudness chart target in the loudness advance menu (Loud. Adv - see section 5.4.6).
<i>Follow Metadata</i>	The loudness chart target is defined within the extracted Dolby metadata program.

1st Loudness/2nd Loudness - Input Selection

You can manually assign a physical channel to each available loudness input position, if the program selection is set to manual and the coding mode permits the position assignment.

A coding mode 2/0 (L, R) will only permit channels to be assigned to the L and R positions.
 A coding mode 1/0 (C) will only permit a channel to be assigned to the C position.



Note that you cannot assign the same channel twice.

5.4.6 Audio - Loudness Advanced



1st Loudness/2nd Loudness - EBU Mode

<i>Checked</i>	The loudness chart will follow the EBU R128 recommendation for the loudness measurement.
<i>Unchecked</i>	A parameter that is not compliant with EBU R128 has been changed (e.g.: Target parameter is not set to -23).



Note that if there are stars in front of the menu name (e.g.: ** EBU Mode) it means that the measurement respects the EBU algorithm except parameters that were manually changed. These changes could affect the results.

1st Loudness/2nd Loudness - A-85 Mode

<i>Checked</i>	The loudness chart will follow the ATSC A/85 recommendation for the loudness measurement.
<i>Unchecked</i>	A parameter that is not compliant with ATSC A/85 has been changed (e.g.: Target parameter is not set to -24).



Note that if there are stars in front of the menu name (e.g.: ** A-85 Mode) it means that the measurement respects the EBU algorithm except parameters that were manually changed. These changes could affect the results.

1st Loudness/2nd Loudness - Target

This parameter will change the target value in loudness chart. Altering this value will unchecked the EBU or A-85 Mode.

1st Loudness/2nd Loudness - Short-Term Time Window

Changing this parameter affects the short term calculation. Altering this value will unchecked the EBU or A-85 Mode. The choices are:

- 1 sec
- ..
- 15 sec

1st Loudness/2nd Loudness – Relative Gating

Changing this parameter affects the relative gating calculation. Altering this value will unchecked the EBU or A-85 Mode. The choices are:

- 8 dB
- 10 dB





Loudness measurement summary

Mode	Momentary	Short Term	Integrated	Gate	Target	Range
<i>EBU</i>	400 ms sliding window	3 sec sliding window	infinite sliding window	affecting integrated measure	-23 dBFS	yes
<i>A-85</i>	400 ms sliding window	10 sec sliding window	infinite sliding window	none	-24 dBFS	no

Refer to EBU R128 or ATSC A/85 specification for more specific details.

Other loudness standard supported

You can use the Kaleido-Solo to measure loudness following other standards by configuring some parameters. You can find those parameters in the next table:

Standard	Unit	EBU Mode	A-85 Mode	Target	Short-Term Time Window (sec)	Relative Gating (dB)
<i>EBU MODE G8</i>	LUFS			-23	3	-8
<i>EBU MODE G10</i>	LUFS			-23	3	-10
<i>ATSC A/85 ITU-r BS.1770-1</i>	LKFS			-24	10	N/A
<i>ATSC A/85 ITU-r BS.1770-2</i>	LKFS			-24	10	-10
<i>ARIB</i>	LKFS			-24	3	-10

5.4.7 Audio - Loudness Control

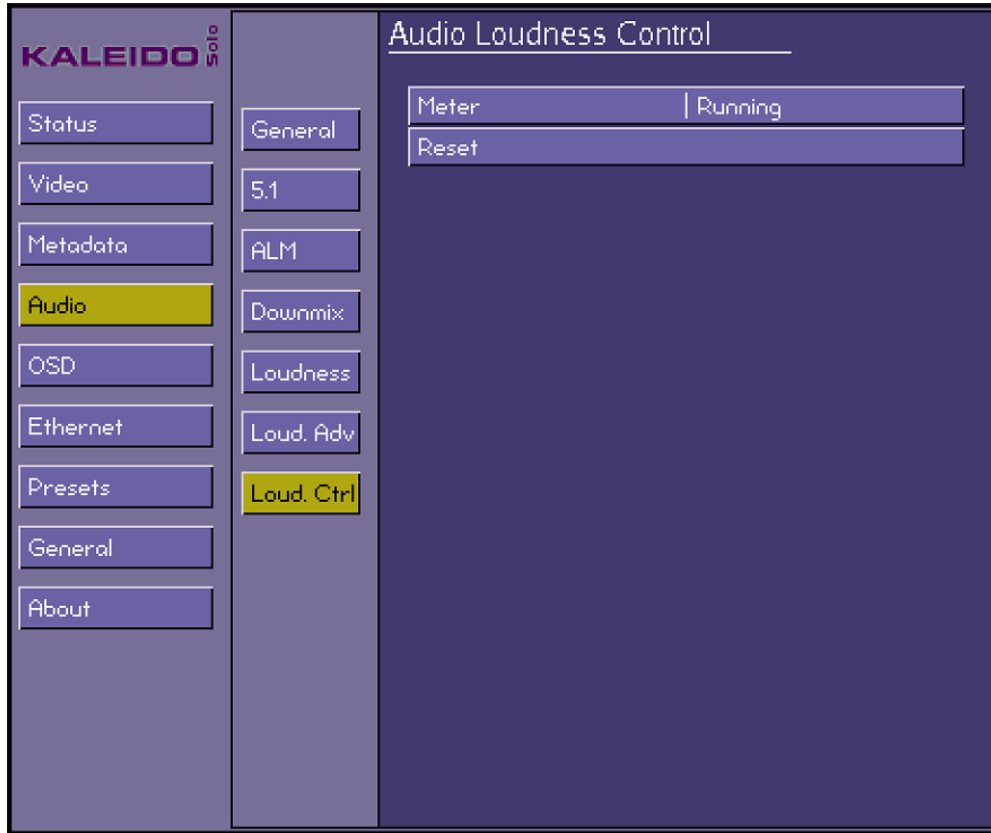

Meter

<i>Paused</i>	Force loudness chart 1 and/or 2 to pause. When paused, the loudness chart will display “pause” and last data will stay on screen.
<i>Running</i>	When loudness engine goes from a paused state to a running state, the engine is restarted and continues where it was left. A special case occurs for EBU LRA measurements that need valid short term values - no new LRA measurements will be displayed until the “Short-Term Time Window” has elapsed (e.g.: For EBU mode, this value is 3 sec).

Reset

<i>Ok</i>	Reset all loudness measurements - traces on the loudness (1 or 2) chart.
<i>Cancel</i>	Return to the menu without any alteration.

5.5 On Screen Display (OSD) Menu

5.5.1 OSD - General



Transparency

Affects all OSD elements except the menu

5:	Transparent
...	
0:	Opaque

Show OSD

Acts as a Master Switch affecting all OSD elements except the menu

<i>Checked:</i>	Enable the display of OSD elements. Each OSD element has its own show/hide parameter e.g.: loudness chart.
<i>Unchecked:</i>	Disable all OSD elements, irrespective of their individual Show/Hide setting.



Note that if the OSD is turned off the video signal is still displayed.

5.5.2 OSD - Loudness



Loudness measurement is available in Kaleido-Solo model **910** only.



This menu controls the appearance of the on-screen loudness chart.

Display

<i>Off</i>	Disable any loudness chart.
<i>Mono Meter 1</i>	Shows 1 loudness chart with first program settings see section 5.4.5.
<i>Mono Meter 2</i>	Shows 1 loudness chart with second program settings see section 5.4.5.
<i>Dual Meter</i>	Shows 2 loudness chart with both first and second program settings see section 5.4.5.



Note that the mono meter and the dual meter are different in their respective graphical representation.

Dual Loudness 1/2

When dual meter is selected you have the choice to only show 1 of the meter or both of them.

<i>Checked</i>	Display the associated loudness chart when Dual Meter is selected.
<i>Unchecked</i>	Hide the associated loudness chart when Dual Meter is selected.

Short Term

<i>Checked</i>	Display the short term trace in both loudness charts.
<i>Unchecked</i>	Hide the short term trace in both loudness charts.

Integrated

<i>Checked</i>	Display the integrated trace in both loudness charts.
<i>Unchecked</i>	Hide the integrated trace in both loudness charts.

Target (Dialnorm)

<i>Checked</i>	Display the target trace in both loudness charts.
<i>Unchecked</i>	Hide the target trace in both loudness charts.

Chart Value Scale

+9	All loudness charts will use a scale of -41.0 LUFS/LKFS to -14.0 LUFS/LKFS (-18.0 LU/dB to +9.0 LU/dB).
+18	All loudness charts will use a scale of -59.0 LUFS/LKFS to -5.0 LUFS/LKFS (-36.0 LU/dB to +18.0 LU/dB).

Chart Time Scale

Set the horizontal time scale of the loudness chart to the desired duration:

30 Sec
 60 Sec
 90 Sec
 120 Sec
 5 Min
 10 Min
 15 Min
 30 Min
 60 Min
 90 Min
 120 Min

Position

Move all loudness charts to the desired position on the screen:

- Top Left
- Top Center
- Top Right
- Bottom Left
- Bottom Center
- Bottom Right
- Center

Loudness chart (mono meter representation)

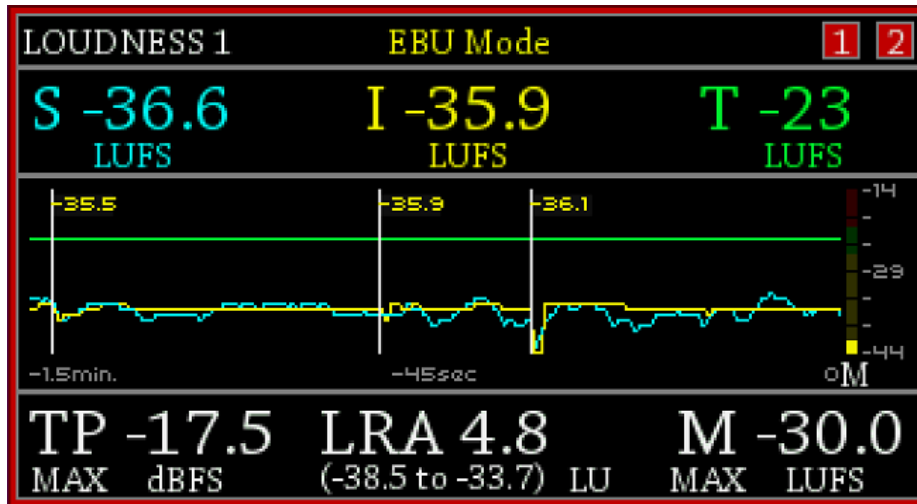

The color identifies the traces (center section) with their numeric values (top section).

<p><i>Top/Bottom section</i></p>	<p>Refer to EBU R128 or ATSC A/85 specification for more details.</p> <p>S: Short term, since last reset. I: Integrated, since last reset. T: Target. TPmax: Maximal true peak, since last reset. LRA: Loudness range. Mmax: Maximal Momentary, since last reset.</p>
<p><i>Top right section</i></p>	<p>Shows if the alarm condition (see Loudness chart alarm) is triggered (RED) by the measure 1 and/or 2. Both charts are active at all time but only one can be displayed at a time.</p>
<p><i>Center section</i></p>	<p>Graphic representation of the short term, integrated measurement and the target value. The time scale is represented at the bottom of this section. Those traces can be independently shown or hidden (see section 5.5.2). The “EBU Mode or A85 Mode” is displayed only when the measurements are compliant to those specifications (see section 5.4.6). Markers appear when an audio loudness control reset is applied (see section 5.4.7). The integrated value for the segment will appear next to the marker.</p>
<p><i>Center Right section</i></p>	<p>Meter that represents the momentary measurement.</p>

Loudness chart (dual meter representation)

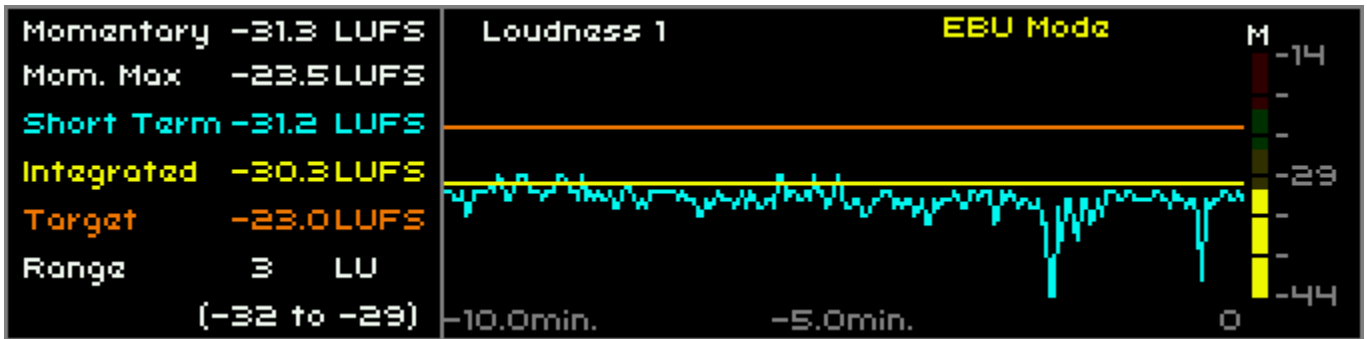

The color identifies the traces (center section) with their numeric values (left section).

<i>Left section</i>	Refer to EBU R128 or ATSC A/85 specification for more details.
<i>Center section</i>	Graphic representation of short term, integrated measurement and the target value. The time scale is represented at the bottom of this section. Those traces can be independently shown or hidden (see section 5.5.2). The “EBU Mode or A85 Mode” is displayed only when the measurements are compliant to those specifications (see section 5.4.6).
<i>Right section</i>	Meter that represents the momentary measurement.

Loudness chart alarm

When the integrated value goes outside the upper and lower tolerance an alarm is triggered. A red frame will appear around the loudness chart. You can trigger the GPI out with this alarm (see section 5.9).

Standard	Unit	EBU Mode	A-85 Mode	Target	Upper/Lower Alarm Tolerances	Alarm Compliance
<i>EBU MODE G8</i>	LUFS	✓		-23	-22/-24	True
<i>EBU MODE G10</i>	LUFS	✓		-23	-22/-24	True
<i>ATSC A/85 ITU-r BS.1770-1</i>	LKFS		✓	-24	-22/-26	True
<i>ATSC A/85 ITU-r BS.1770-2</i>	LKFS	✓		-24	-22/-26	False (-23/-25)
<i>ARIB</i>	LKFS	✓		-24	-21/-27	False (-23/-25)



Note that the alarm tolerances are not configurable.

5.5.3 OSD - ALM



This menu sets up the appearance of the on-screen Audio Level Meters.

Control - Show ALM

Choose whether to display the on-screen ALMs:

<i>Checked</i>	Show all audio level meters.
<i>Unchecked</i>	Hide all audio level meters.

Control - Scale

<i>Checked</i>	Show scales on all audio level meters - levels are in dB.
<i>Unchecked</i>	Hide scales on all audio level meters.

Control - Channel ID

<i>Checked</i>	Show the identity (channel numbers) on all audio level meters.
<i>Unchecked</i>	Hide the identity (channel numbers) on all audio level meters.

ALM Standard – ALM 5.1 (no. 1 and no. 2)

<i>Off</i>	Hide the 5.1 audio level meters giving the space to show up to 3 stereo audio level meters.
<i>Other types</i>	See ALM1,2,etc type for more details.

ALM Standard - ALM1, ALM2, etc.

For each of the eight available ALMs,

<i>Off</i>	Hide the stereo meter.
<i>Other types</i>	See next picture and next table to see all representation supported.

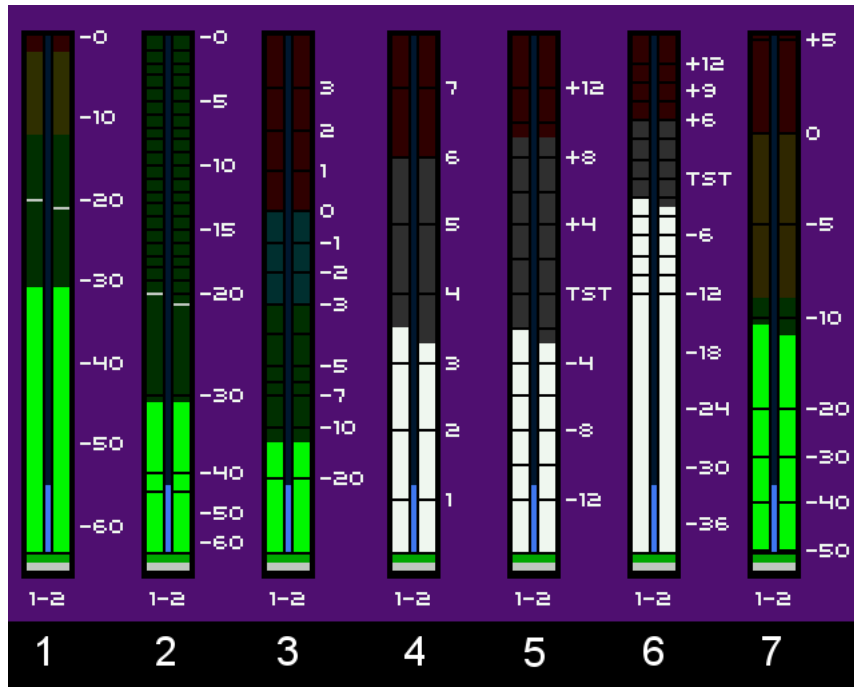

Note that the numbers 1 to 7 on black background (image bottom numbers) are just here for the purpose of the manual and cannot be displayed on the video output of the Kaleido-Solo.

1	Linear (Digital type VU (Green bars) + Peak (White horizontal lines))
2	EBU Digital (Digital type VU (Green bars) + Peak (White horizontal lines)) (IEC60268-18)
3	VU Meter (Analog VU) (IEC60268-17)
4	UK PPM (Analog peak) (IEC60268-10 type IIa)
5	EBU PPM (Analog peak) (IEC60268-10 type IIb)
6	Nordic PPM (Analog peak) (IEC60268-10 type I)
7	DIN PPM (Analog peak) (IEC60268-10)

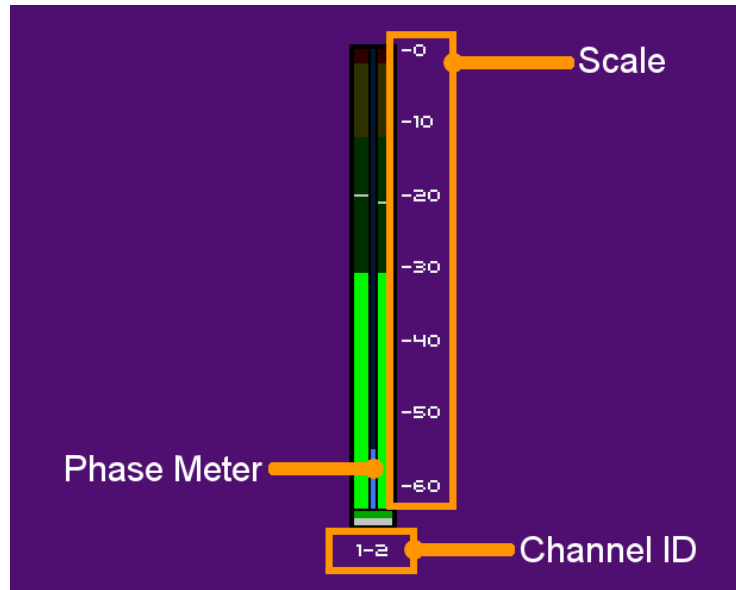

<i>Scale</i>	Scale is the graduation in dB of an audio level meter.
<i>Channel ID</i>	Identifies the audio channel pair represented by audio level meter.
<i>Phase meter</i>	Provides an indication of the relative phase of the two channels and thereby provides some measure of mono compatibility. The range is 0 to 180 degrees and is represented as follows: bottom is 0 degrees and top is 180 degrees.

5.1 channel assignment

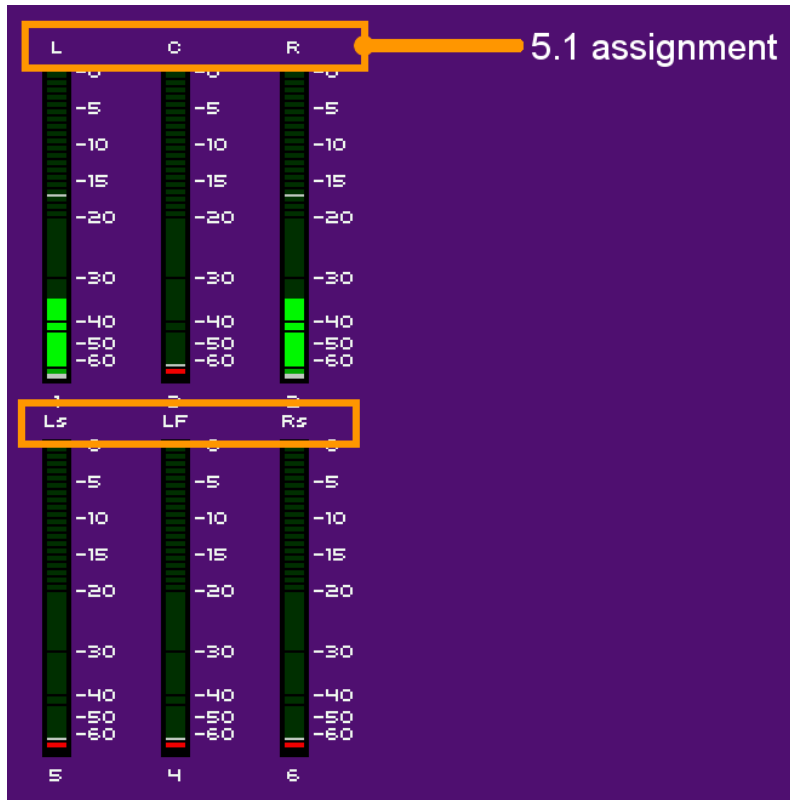

<i>L</i>	Stands for front left
<i>C</i>	Stands for center
<i>R</i>	Stands for front right
<i>LS</i>	Stands for left surround
<i>LF</i>	Stands for subwoofer
<i>RS</i>	Stands for right surround



Note that all ALMs are in true peak mode (not selectable) (as explained in document ITU-R BS.1770-1 annex 2).

5.5.4 OSD - Timecode



Time Code Show

Set the location on the display monitor where the time code will be displayed, or turn it off:

- Off
- Top Left
- Top Center
- Top Right
- Bottom Left
- Bottom Center
- Bottom Right

Time Code - Font Size

Set the size of the font used to display the time code:

<i>Big</i>	Selects the big font 
------------	---

Small	Selects the small font 19:30:43:25
-------	--

The samples show the relative sizes of the fonts.

5.5.5 OSD – Asp. Ratio



Asp. Ratio - Show

Set the location on the display monitor where the AFD code extracted from the input will be displayed, or turn it off:

- Off
- Top Left
- Top Center
- Top Right
- Bottom Left
- Bottom Center
- Bottom Right

5.5.6 OSD – In. Format

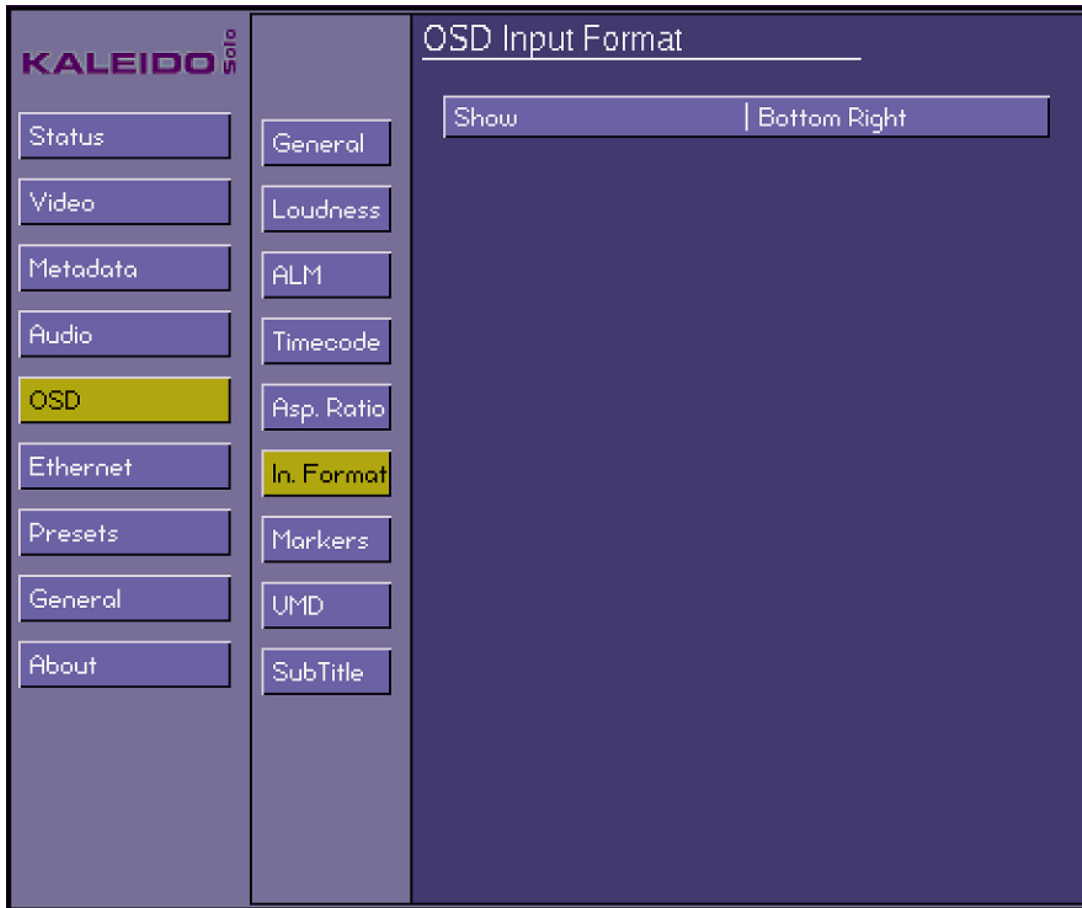

In. Format Show

Set the location on the display monitor where the input format will be displayed, or turn it off:

- Off*
- Top Left*
- Top Center*
- Top Right*
- Bottom Left*
- Bottom Center*
- Bottom Right*

5.5.7 OSD - Markers



4:3 Markers - Line

Choose whether to show 4:3 markers within the 16:9 video displays

<i>No Lines</i>	Marker are not displayed.
<i>Lines</i>	Markers are displayed.



4:3 Markers - Mask

The area of the image that is outside the protected area as shown by the markers can be masked, and the mask selected as transparent or opaque, using this menu.

<i>Off</i>	No mask applied.
<i>Opaque</i>	Mask is applied and completely blocks video.
<i>Transparent</i>	Mask is applied and video can be seen through mask.

The 4:3 line or mask will appear only when the active output resolution is 16:9 (e.g.: 1920x1080p60). For this behavior the 4:3 line/4:3 mask must not be set to off.

5.5.8 OSD - UMD

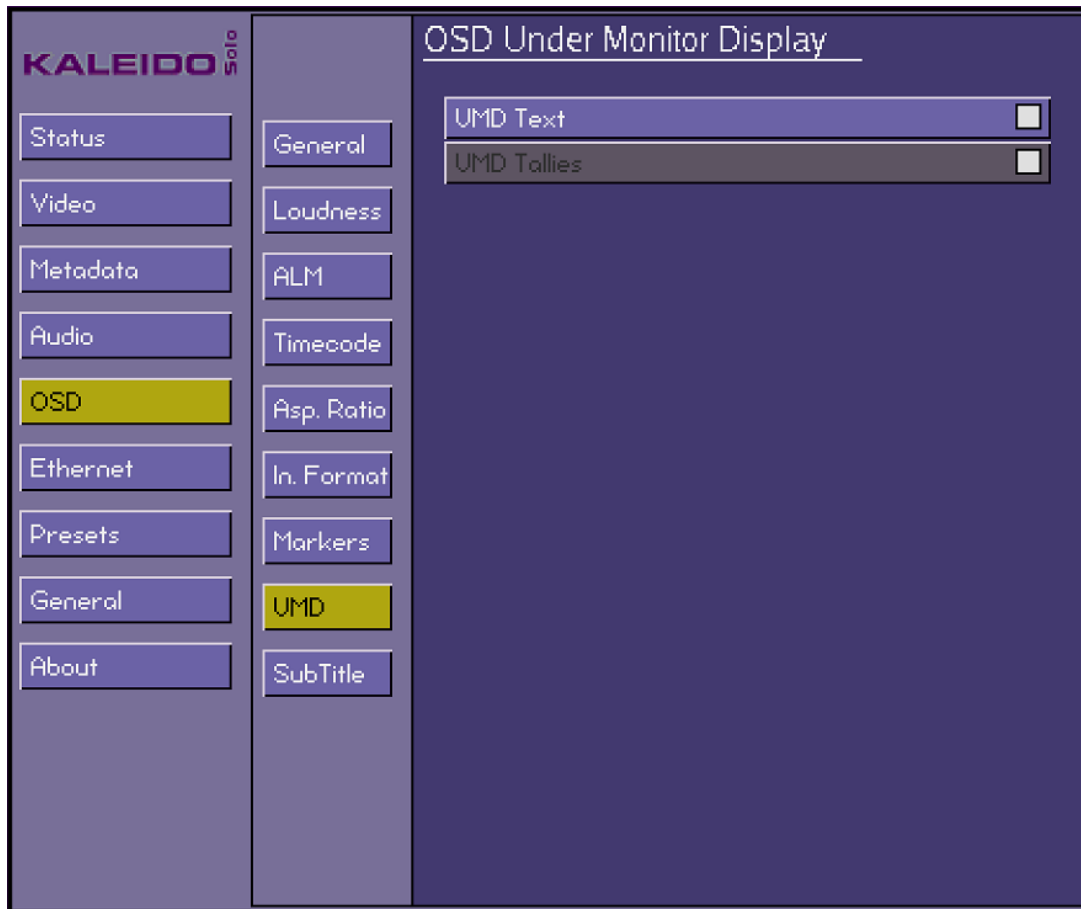

Under monitor display (UMD)



Under monitor display (UMD) with tallies



Dynamic text can be driven by some automation systems.



Note that the ID number for the Kaleido-Solo UMD text box is '0' and the port number is '13000'. This is useful when configuring the third-party automation system see section 6.

5.5.9 OSD - SubTitle



Subtitling

<i>Unchecked:</i>	Disable burn in subtitling.
<i>Checked:</i>	Enable burn in subtitling.



Note that if the video is scaled to use a small portion of the monitor the subtitling may be illegible but still present.

5.6 Ethernet

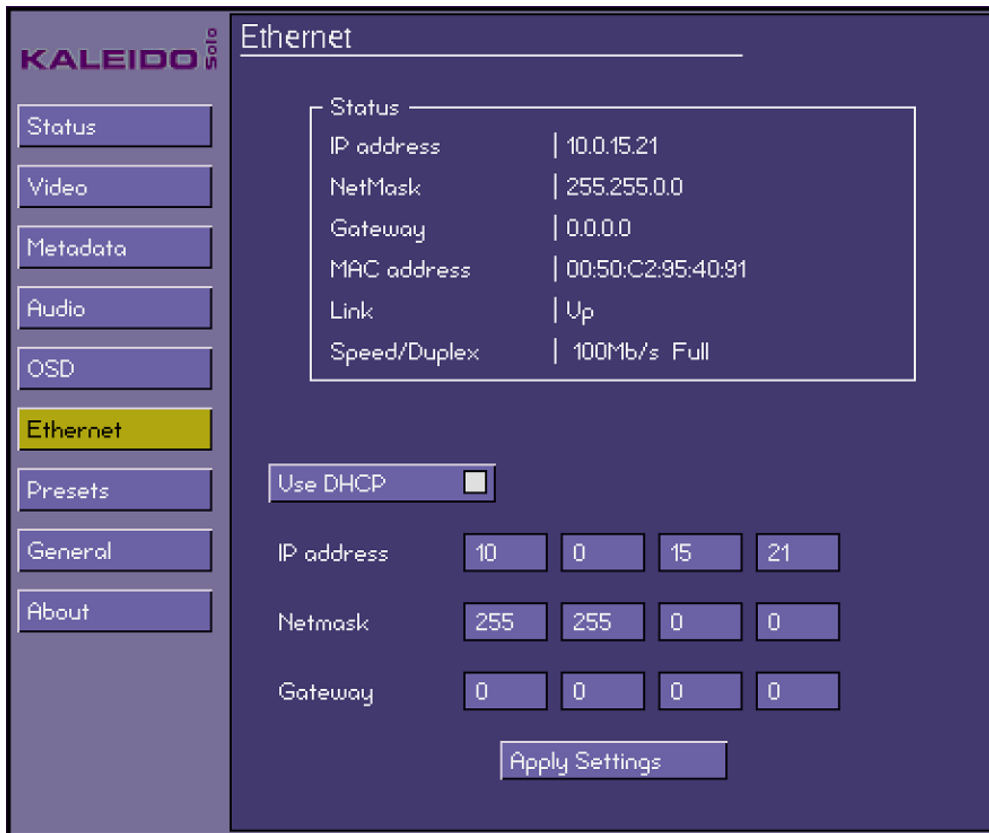

Status

Information related to the Ethernet connection e.g.: IP address, etc.

Use DHCP

<i>Unchecked:</i>	Use manually-entered IP address.
<i>Checked:</i>	Let the DHCP server on your network to assign an IP address every time you power-up the Kaleido-Solo.

IP Address

An Internet Protocol address (IP address) is a numerical label assigned to each device participating in a computer network that uses the Internet Protocol for communication. You can set the address IP here.

Netmask

Netmask configures the subnetwork. A subnetwork, or subnet, is a logically visible subdivision of an IP network. You can set the netmask here.

Gateway

A network node equipped for interfacing with another network that uses different protocols. You can put the IP address of a gateway here.

Apply Settings

After IP, Netmask and Gateway addresses are entered, navigate to the “Apply Settings” button and click on it. Wait a few seconds to see the Status box information change accordingly. If DHCP is checked, the IP is the one provided by your network DHCP server.

5.7 Presets



User Presets

You can save and load up to 5 presets. Everything can be saved and recalled in a preset except for:

- Ethernet configuration (see section 5.6)
- Safe mode configuration (see section 5.11)
- Analog Volume (see section 3.1)
- Remote control buttons assignment (see section 5.8)
- GP I/O assignment (see section 5.9)

Default Preset

If activated, everything will be reseted to factory default except for:

- Ethernet configuration (see section 5.6)
- Safe mode configuration (see section 5.11)

5.8 General - Remote

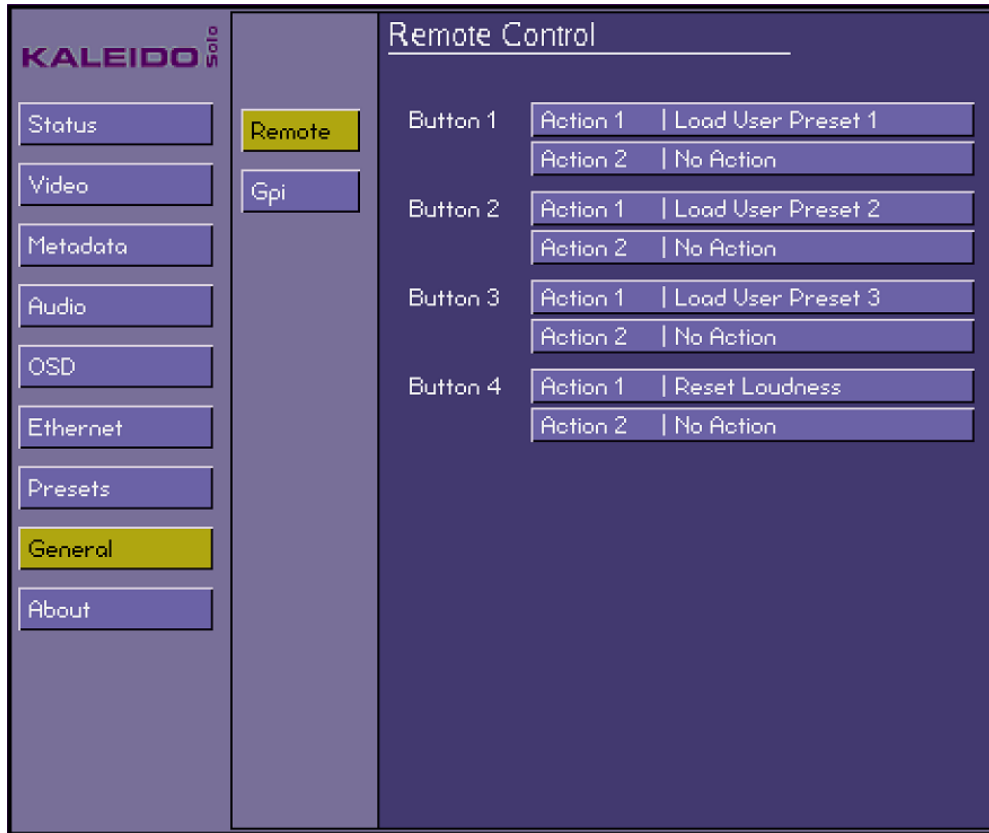

You can assign up to 2 actions to the optional remote control buttons #1 to #4 (see section 12). Here are the possibilities:

<i>No Action:</i>	Nothing.
<i>Load User Preset 1 to 5:</i>	Load a previously saved associated preset (see section 5.7).
<i>Reset Loudness:</i>	Reset loudness measurement (see section 5.4.7).
<i>Pause Loudness:</i>	Pause loudness measurement (see section 5.4.7).
<i>Run Loudness:</i>	Run loudness measurement (see section 5.4.7).
<i>Toggle Loudness 1 and 2</i>	This is a special action to toggle between loudness mono meter chart #1 and #2 (see section 5.5.2).

When you press a button once, the Action 1 is triggered. To access Action 2 you will have to press the same button again.

5.9 General - GPI

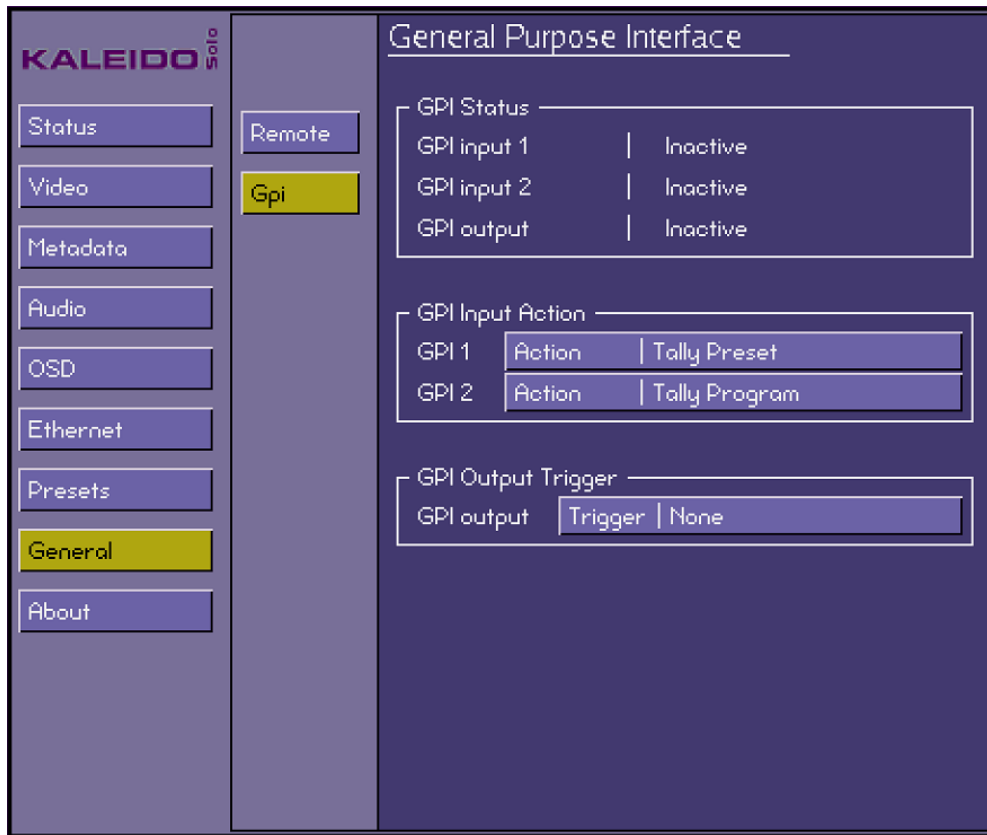

See section 2.3 for GPI connections.

GPI Status

<i>Active:</i>	Shows if the GPI inputs and/or output are considered active (close).
<i>Inactive:</i>	Shows if the GPI inputs and/or output are considered inactive (open).

GPI Input Action

You can assign an action from a GPI input. This action will occur when the associated GPI is detected as active. Here are the possibilities:

<i>No Action:</i>	Nothing.
<i>Load User Preset 1 to 5:</i>	Load a previously saved associated preset (see section 5.7).
<i>Reset Loudness:</i>	Reset loudness measurement (see section 5.4.7).
<i>Run/Pause Loudness:</i>	Toggle between run and pause loudness measurement base on the GPI input level (Inactive = Run, Active = Pause) (see section 5.4.7).
<i>Tally Program:</i>	Activate the left most tally (see section 5.5.8).

<i>Tally Preset:</i>	Activate the right most tally (see section 5.5.8).
<i>Status WARNING:</i>	Activate a Warning mode, UMD and UMD text will turn yellow and a yellow border will appear on the border of the screen.
<i>Status ERROR:</i>	Activate an Error mode, UMD and UMD text will turn red and a red border will appear on the border of the screen.

GPI Output Trigger

You can define a trigger to activate the GPI output. Here are the possibilities:

<i>None:</i>	Nothing.
<i>Loudness Meter 1 Error</i>	Activate the GPI output when the loudness measurement 1 is in error (alarm) (see section 5.5.2).
<i>Loudness Meter 2 Error</i>	Activate the GPI output when the loudness measurement 2 is in error (alarm) (see section 5.5.2).
<i>GPI Input 1</i>	Loop GPI Input 1 status to GPI Output.
<i>GPI Input 2</i>	Loop GPI Input 2 status to GPI Output.

5.10 About Menu



This screen identifies this specific Kaleido-Solo's model and version number. This information will be required if you need assistance from Miranda technical support.

There are other elements on this page labeled B, C, F and M that could be needed by the Miranda technical support.

If a remote control is detected it will be identified with the version of the remote control.

You can also find if an XML Gateway connection has been established and see the host IP address.

There is also a fan health indicator. If you see 100%, try to reboot before contacting Miranda technical support.

5.11 Safe Mode

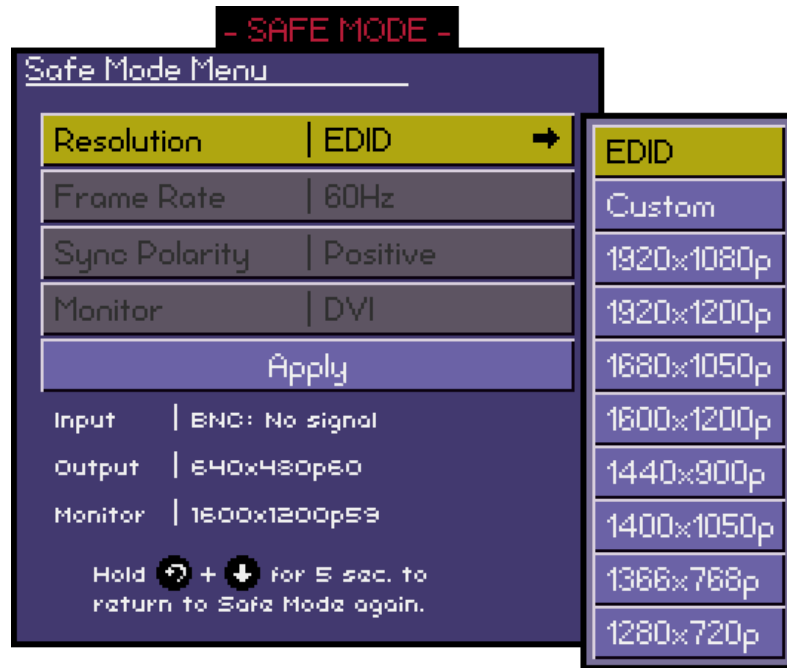

Safe mode is a specialized operating mode designed to allow the user to force an HDMI resolution. This can be used if the monitor's preferred resolution is not supported or if the monitor has a corrupted EDID (no valid preferred resolution information).

To enter the Safe mode, push **ESCAPE** and **DOWN** together and hold for 5 seconds.

The Kaleido-Solo will output a 640x480p60 resolution if no or 50Hz video input is detected. If 59.94Hz is detected at the input the safe mode resolution will be 640x480p59.94. 640x480 is chosen to be almost universally accepted by video monitors

The Safe Mode Menu will be shown on the screen, allowing some operating parameters of the Kaleido-Solo to be set manually.

Resolution

The Output resolution of the Kaleido-Solo can be set to one of the following fixed values, or it can be set to follow the EDID from the monitor. The EDID is information reported by the monitor that describes, among other things, its preferred resolution and if it supports audio.

<i>EDID:</i>	Follow the preferred monitor resolution every time (power-up or connect a new monitor).
<i>1920x1080p</i>	Force a 1920x1080p resolution every time (power-up or connect a new monitor).
...	
<i>640x480p</i>	Force a 640x480p resolution every time (power-up or connect a new monitor).

Frame Rate

Choose the frame rate of the output video. This option can be selected only if the resolution is not set to EDID.

- 50 Hz
- 60 Hz

Sync Polarity

<i>Positive:</i>	Positive horizontal and vertical syncs.
<i>Negative:</i>	Negative horizontal and vertical syncs.

Monitor

<i>HDMI:</i>	Monitor supports audio.
<i>DVI:</i>	Monitor does not support audio.

Apply

Push **ENTER** to apply the settings made in this menu and close the menu.

At the bottom of the display, the following statuses are shown:

<i>Input:</i>	Resolution of the selected input.
<i>Output:</i>	Current resolution of the HDMI output.
<i>Monitor:</i>	Preferred resolution of the monitor (as reported by the EDID).

6 XML Gateway

The XML Gateway is a protocol used to control OSD objects of the Kaleido-Solo.

Below is a table containing all accessible objects from the XML Gateway protocol. The port number use for the connection is '13000'.

Object	ID/Address	Gateway message	Behavior
<i>Picture frame & UMD</i>	0	<setKStatusMessage> status="new status" NORMAL or OK WARNING or MINOR CRITICAL or ERROR	Gray frame, white UMD text Yellow frame and UMD text Red frame and UMD text
<i>UMD</i>	0	<setKDynamicText> Text="new text"	<i>UMD text will change to the requested string. (UMD text source must be configured to use Ethernet)</i>
<i>Program Preset (red-right)</i>	1	<setKStatusMessage> status="new status" NORMAL or OK WARNING or MINOR CRITICAL or ERROR	Unlit tally Red lit tally Red lit tally
<i>Tally Preset (green-left)</i>	2	<setKStatusMessage> status="new status" NORMAL or OK WARNING or MINOR CRITICAL or ERROR	Unlit tally Green lit tally Green lit tally



Note that picture frame, when gray, can be hidden when image fill up the screen. A colored frame will always shows up.

7 Upgrade Procedure

When it becomes necessary to upgrade the Kaleido-Solo to a new software version, use the procedure described here.

The Kaleido-Solo serves a web page that is the portal for upgrading the device.

7.1 Using a crossover RJ45

Connecting a Kaleido-Solo directly to your computer with an Ethernet crossover cable requires particular care. The Kaleido-Solo and your computer must be in the same IP address range.



7.1.1 How to determined the computer (windows 7) IP address

Select “Control Panel” on the “Start” windows menu.

Select “View network status and tasks”

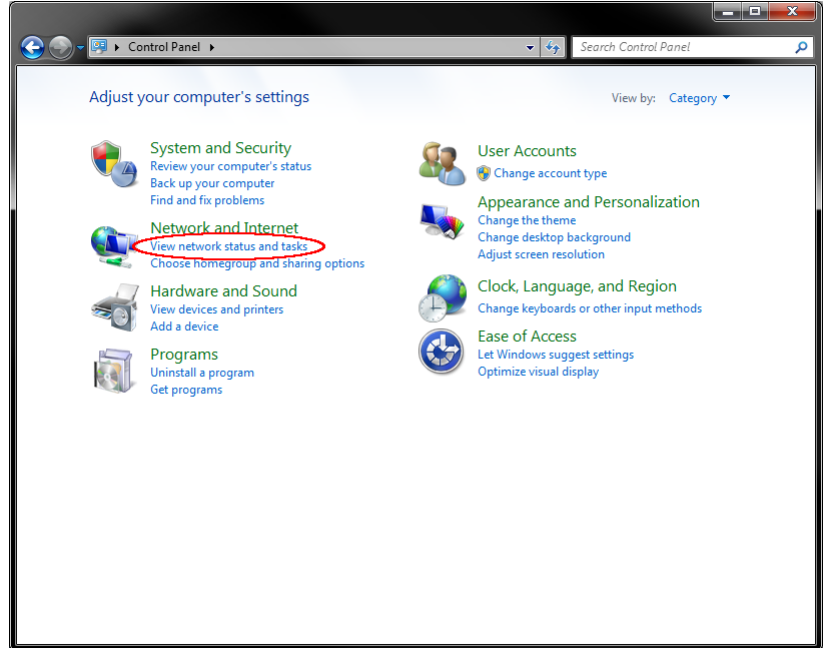

Click on “Local Area Connection”. If you have more than 1 physical network connections choose the right one.

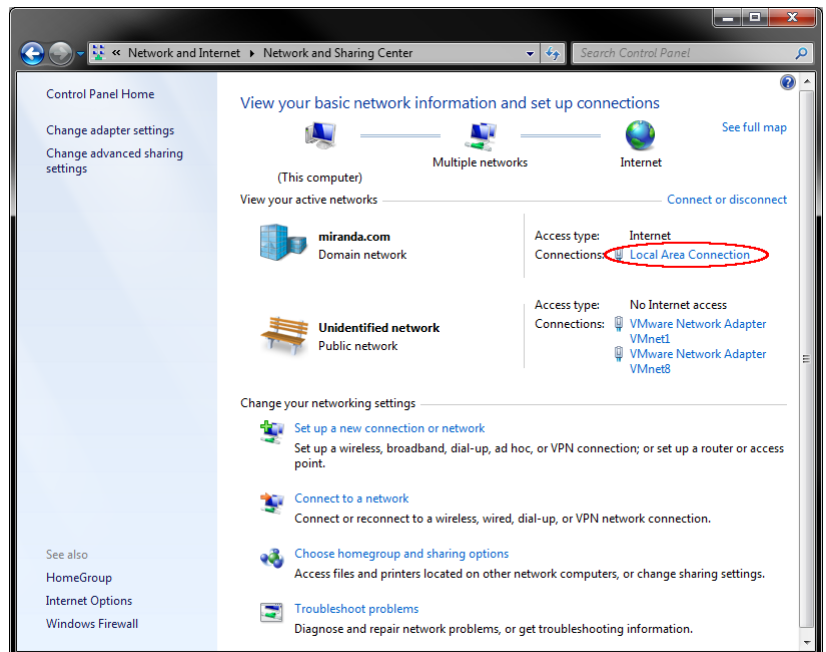

Select “Details...”

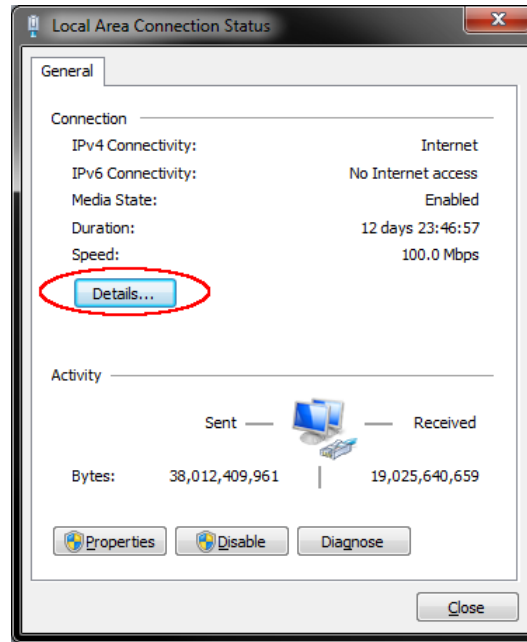

You can now see the computer IPv4 Address. In the case shown here it's 10.0.24.166

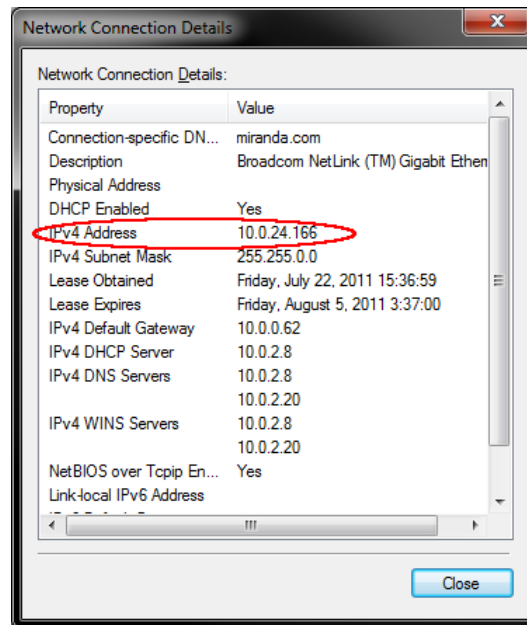

You can configure the Kaleido-Solo to be in the same subnet as your computer by selecting, for example 10.0.24.170.

7.1.2 How to change the computer (windows 7) IP address

In the “Local Area Connection Status” window click on “Properties” instead of “Details...”

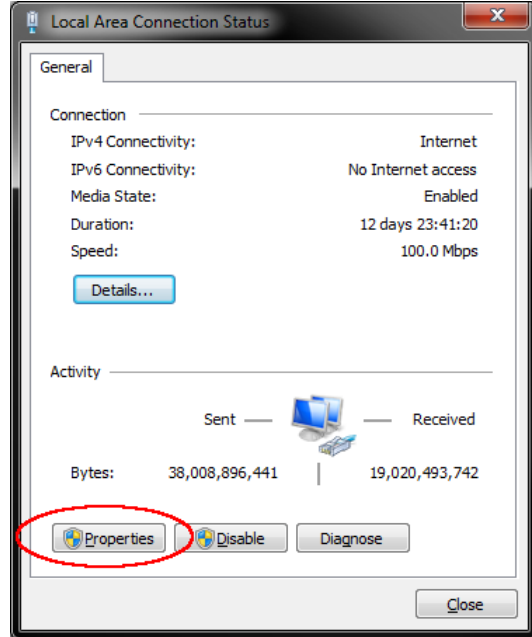

Select the Internet Protocol Version 4 and click on “Properties”

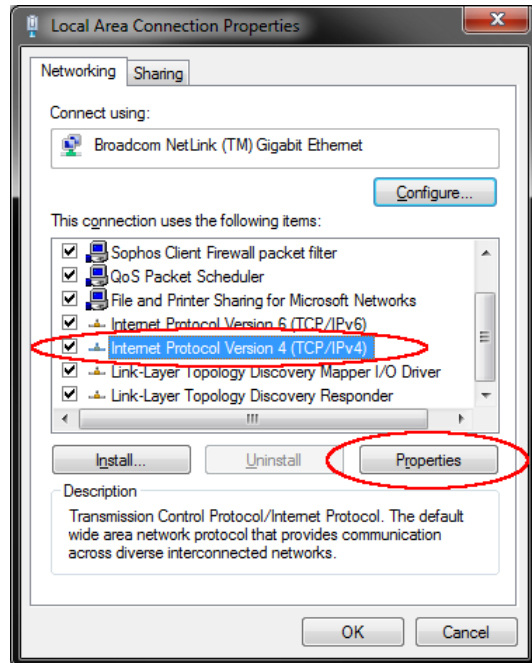

You can now assign a new IP address to your computer.

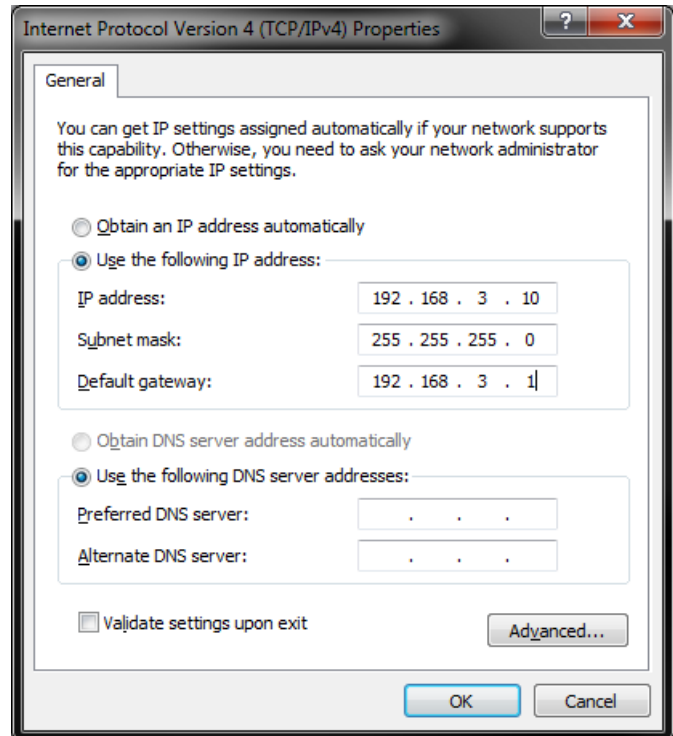

7.2 Connecting to your Kaleido-Solo (LAN connection or crossover connection)

Use a web browser to access the IP address of the Kaleido-Solo that is to be upgraded.

- The current address is always found on the Ethernet menu (see section 5.6).
- The Kaleido-Solo is shipped with its IP address set to 192.168.3.31

Once you have accessed the Kaleido-Solo, the Introduction page appears in your browser window.

Click on the **Upgrade** link to open the Upgrade Kaleido Solo's page.

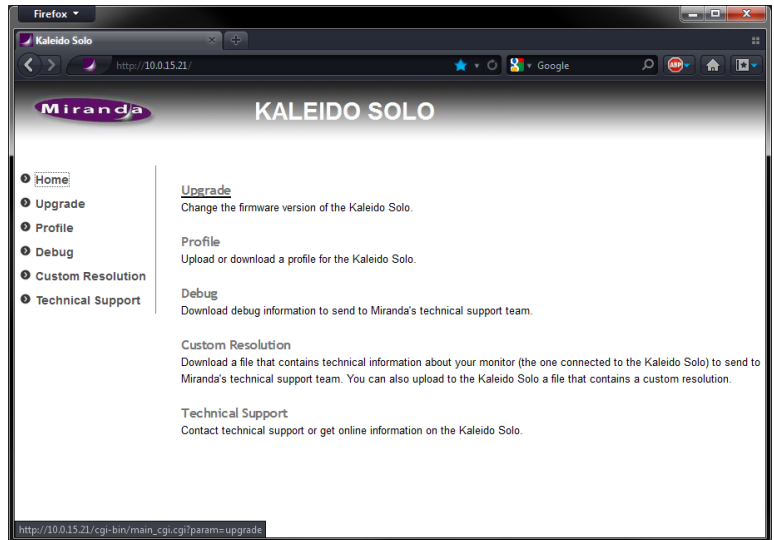

Click on the **Browse** button to open the *Choose File to Upload* dialog box where you can search your local computer or network for the upgrade file, which you should have obtained previously from Miranda.

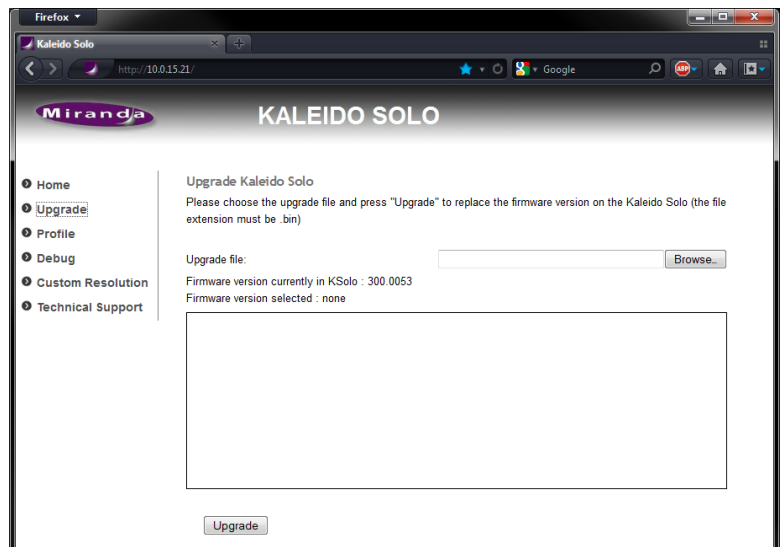

GUIDE TO INSTALLATION AND OPERATION

Select the file and click **Open**. The file name will appear in the *Upgrade File* data box, and the Upgrade button will be enabled.

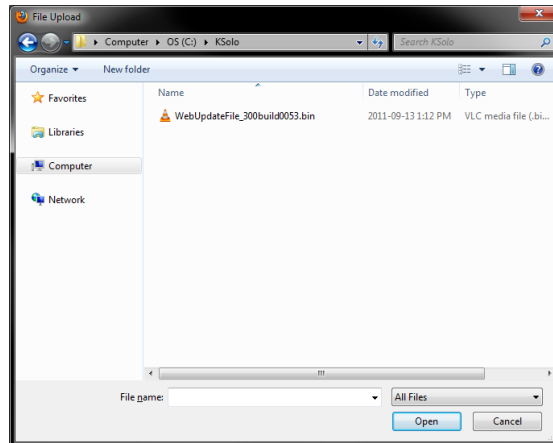

Click the **Upgrade** button to begin the upgrade procedure.

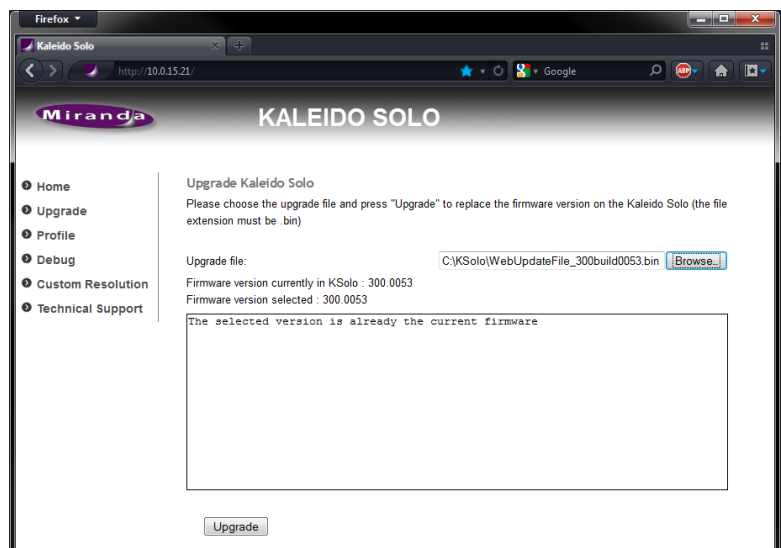

A pop-up warning will appear, listing things you should NOT do while the Kaleido-Solo is upgrading:

When you are ready to proceed, click OK.

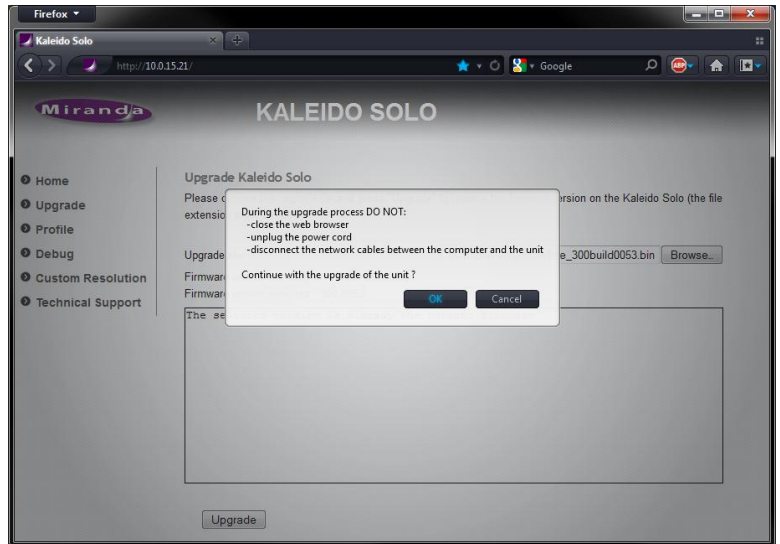

The main window will show that the upgrade is in progress, and remind you of the things NOT to do.

When the upgrade is complete, the main window will notify you that it was successful, and advise you to reboot your Kaleido-Solo.

Reboot the Kaleido-Solo to put the upgraded software into service.

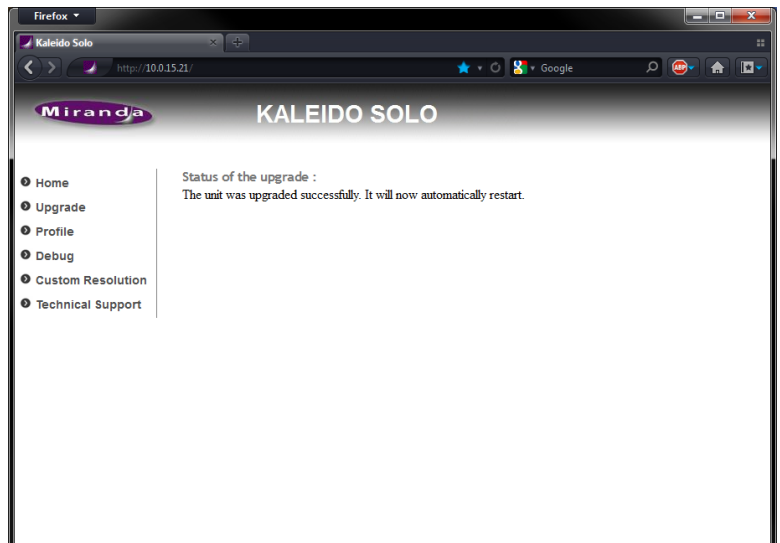

Note that the web page format has changed. If you want to change the version to a previous one the web would not refresh properly. You will see a “404 Not Found”. You will have to clear your browser history. Close the browser and reopen it.

8 Profile

You can copy the configuration of a Kaleido-Solo to another one (excluding the Ethernet configuration) by going to the **profile** section on the Kaleido-Solo's web page.

Connect to the Kaleido-Solo's IP address and select **Profile**

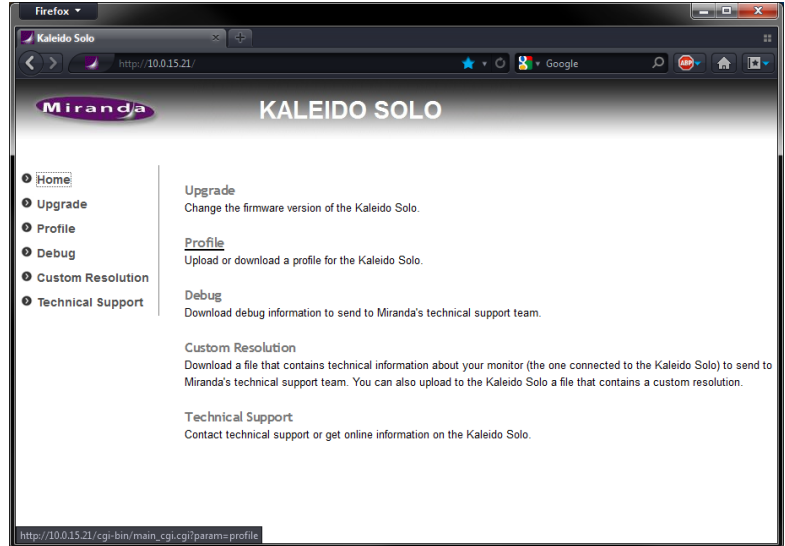

Click on **Download** to download the configuration file (ksolo_profile.tar).

You can upload an existing profile file (ksolo_profile.tar) (previously downloaded from a Kaleido-Solo) to overwrite all parameters except ethernet configuration.

Press **Browse** to select the file to upload and then press on **Upload** to overwrite actual Kaleido-Solo's parameters.

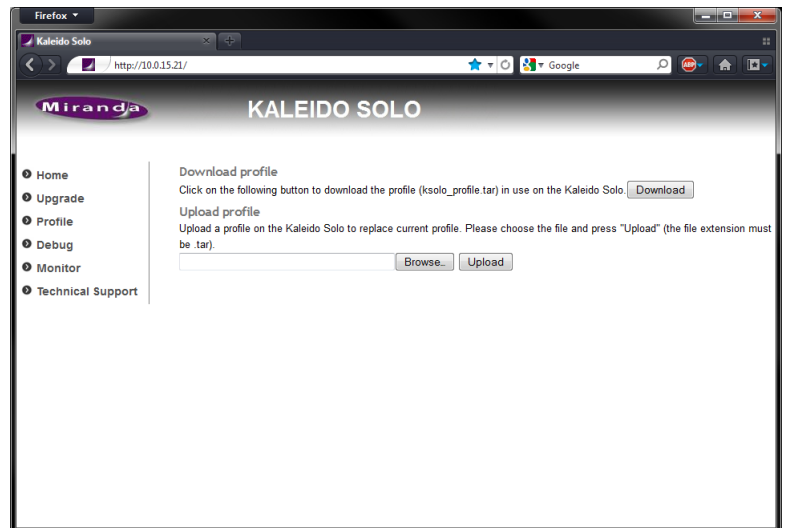

9 Debug information

Debug information file could be required when contacting technical support. You can download the file from the debug web page provided by the Kaleido-Solo.

Connect to the Kaleido-Solo's IP address and select **Debug**

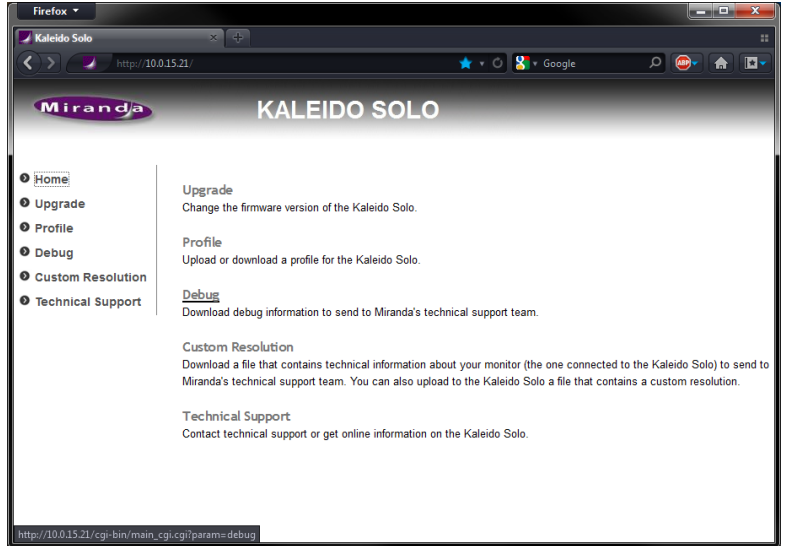

Click on **Download** to download the debug file (ksolo_debug.tar).

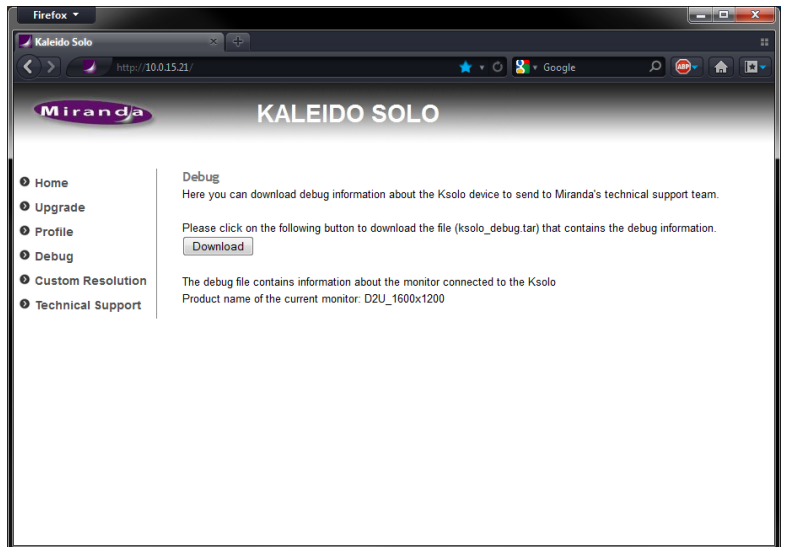

10 Custom resolution

Connect to the Kaleido-Solo's IP address and select **Custom Resolution**

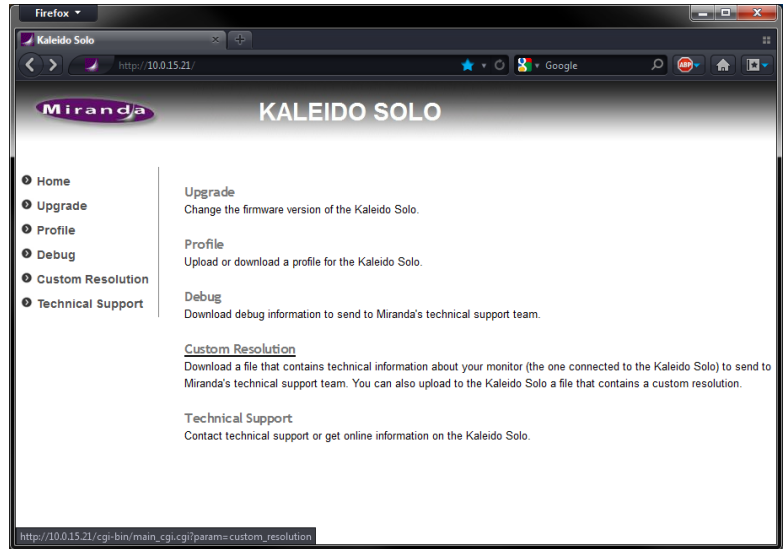

Press **Browse** to select the file to upload and then press on **Upload** to upload the file to the Kaleido-Solo.

The custom resolution file should be obtained from Miranda's technical support. It permits to output unsupported HDMI output resolution.

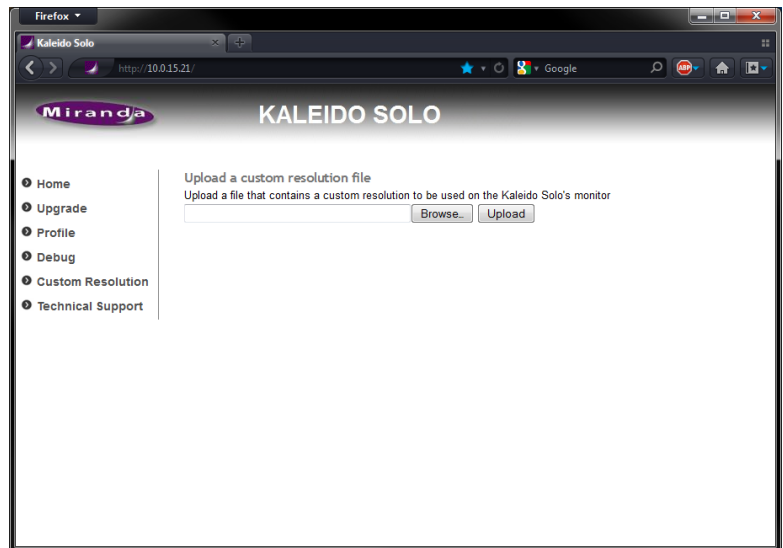

Note that once the file is uploaded you must go in safe mode and select custom under resolution (see section 5.11).

11 Technical support information

Connect to the Kaleido-Solo's IP address and select **Technical Support**

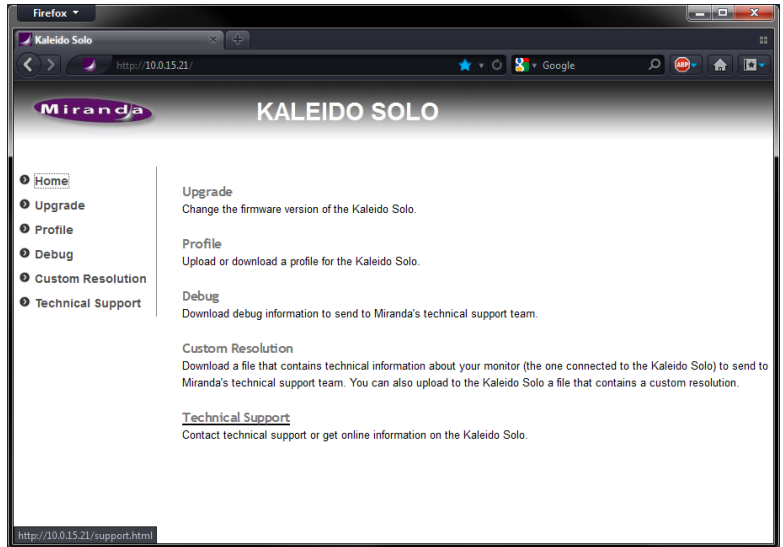

You can find the information required to contact the technical support.

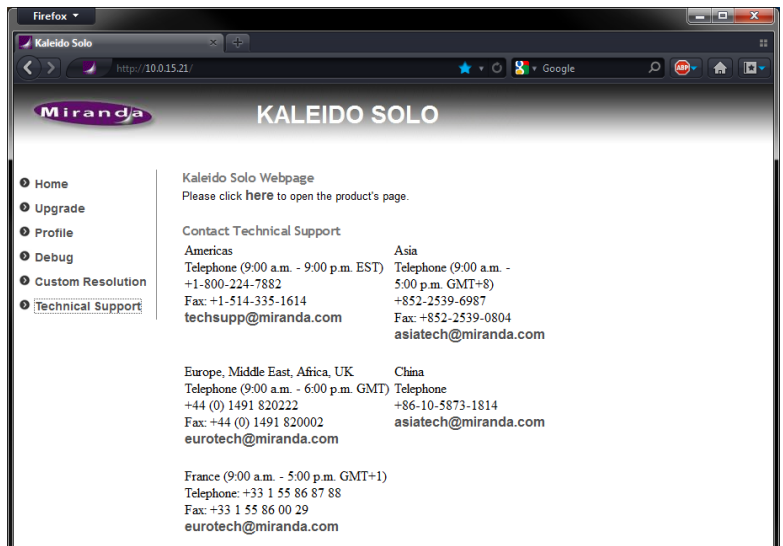

12 Kaleido remote control (optional)

You can connect the optional remote control to your Kaleido-Solo. The remote comes with 6 feet of cable but you can extend it up to 100 feet with standard 4 wires phone cable (RJ-11). The remote uses capacitive sensor button technology. The remote will help configure your Kaleido-Solo, recall presets or control the loudness history graph (KS-910 only) see section 5.8 for details about button 1, 2, 3 and 4 configurations.

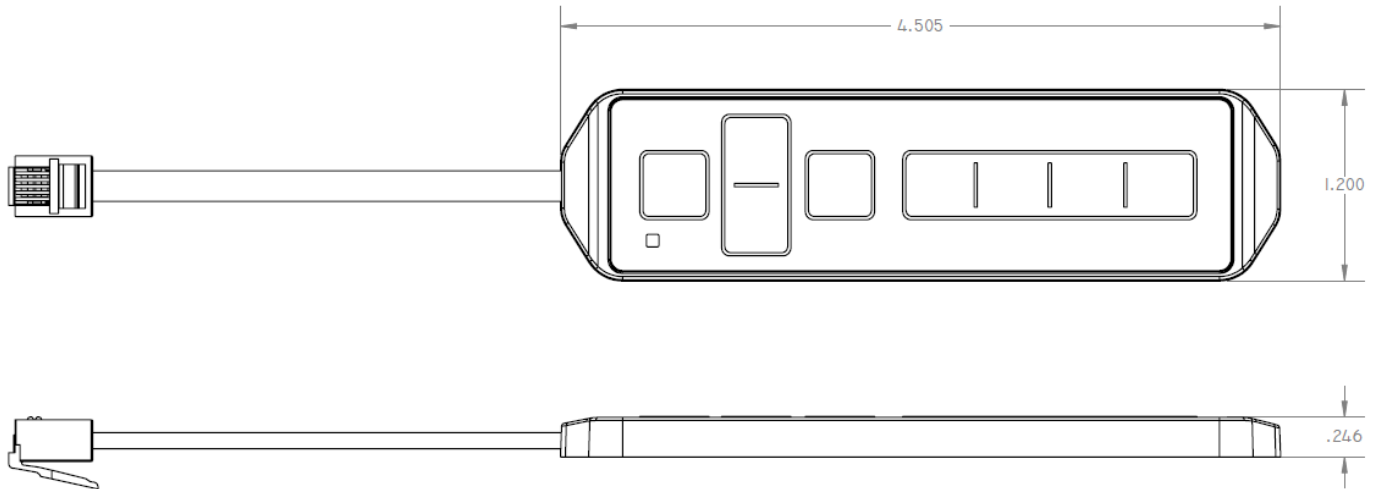
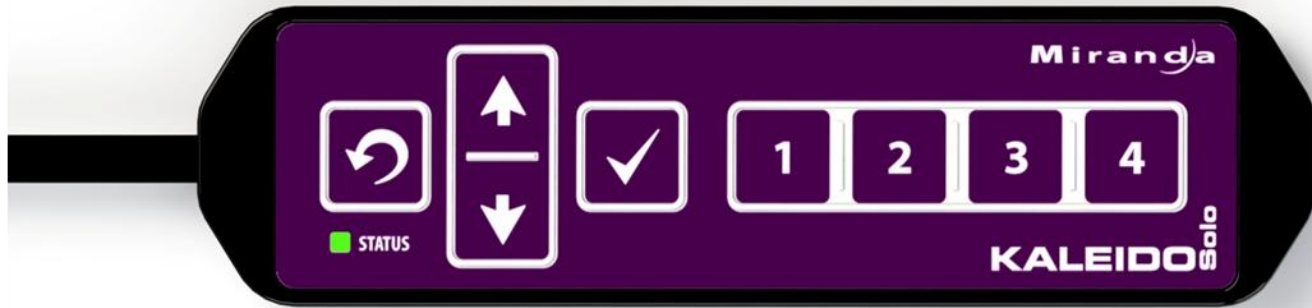

Ordering information: KS-Remote

13 Specifications

VIDEO

Signal:	SMPTE-259M-C (270 Mbps) SMPTE-272M-C (270 Mbps with embedded audio) SMPTE-292M, SMPTE-299M (HD: 1.485, 1.485/1.001 Gbps) SMPTE-425 (2.970, 2.970/1.001 Gbps)
Supported formats:	SD: 480i/59.94, 576i/50 HD: SMPTE-274M: 1080i 50, 59.94, 1080p/PsF 23.98, 24, 25 HD: SMPTE-296M: 720p 50, 59.94 3G: SMPTE-425 level A (mapping 1): 1080p 50, 59.94 3G: SMPTE-425 level B: 1080p 50, 59.94 (Dual Link)
Cable length:	240 m Belden 1694A at 270 Mbps 150 m Belden 1694A at 1.485 Gbps 120 m Belden 1694A at 2.97 Gbps
Return loss:	>15 dB up to 1.5 GHz >10 dB up to 3 GHz
Jitter:	HD/SD: <0.2 UI as per alignment jitter in SMPTE spec. 3Gbps: <0.3 UI as per alignment jitter in SMPTE spec.

FIBER I/O

SMPTE 297M-2006 compliant
Single receive or transmit or receive/transmit SFP module
<ul style="list-style-type: none"> Dual receive or transmit modules can be installed, but only one Rx or Tx channel will be used

HDMI OUTPUT

Connector:	HDMI Type A
Standard:	HDMI 1.3a
Format:	Compliant to EIA/CEA-861-D

ANALOGIC AUDIO OUTPUT

Connector:	3.5 mm stereo Jack
Signal:	2 channels unbalanced analog audio
Level:	2V peak to peak
Impedance:	10 KOhms

SPDIF

Connector:	3.5 mm stereo Jack
Signal:	IEC 60958
Level:	0.5 Vp-p \pm 20%
Impedance:	75 Ohms unbalanced
Sampling rate:	48 kHz

ETHERNET

Connector:	RJ-45
------------	-------

PROCESSING

Signal path:	8 bits
Processing delay:	1 frame

ELECTRICAL

Voltage range:	6 to 17 VDC
Power:	10 W

14 Annex 1: Glossary

<i>Concept</i>	<i>Description</i>
EBU R128	Refer to EBU technical document 3341
ATSC A/85	Refer to document number: ITU-R BS.1770

15 Annex 2: AFD Functions

The charts below show the conversions that will be performed by the Kaleido-Solo by selecting the Active Format Descriptor (AFD).

In the images shown in the chart:

BLACK Indicates that this portion of the transmitted image will be black

GREY indicates Protected Area, consisting of picture content which may be cropped for optimum display on screens with a different aspect ratio.

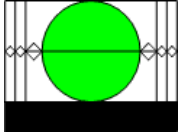
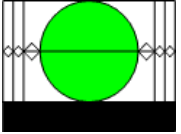
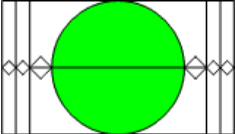
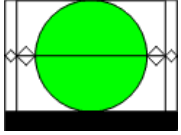
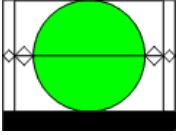
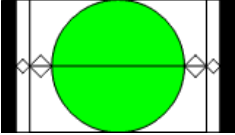
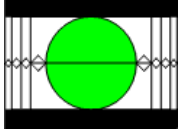
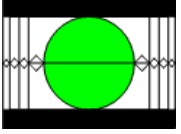
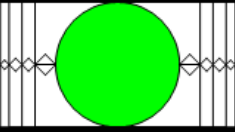
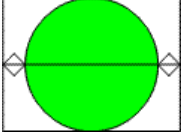
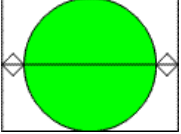
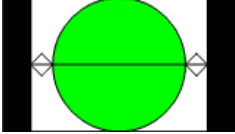
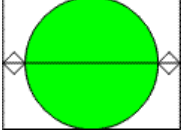
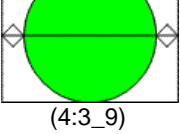
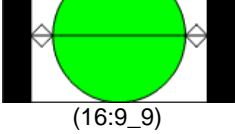
Input signal	4:3 monitor	Output signal	16:9 monitor
16:9 Letterbox (top) image in a 4:3 frame  (4:3_2)	16:9 Letterbox (top) image in a 4:3 frame  (4:3_2)	16:9 Full frame image in a 16:9 frame  (16:9_8)	
14:9 Letterbox (top) image in a 4:3 frame  (4:3_3)	14:9 Letterbox (top) image in a 4:3 frame  (4:3_3)	14:9 Pillar-box image in a 16:9 frame  (16:9_11)	
> 16:9 Letterbox (center) image in a 4:3 frame  (4:3_4)	> 16:9 Letterbox (center) image in a 4:3 frame  (4:3_4)	> 16:9 Letterbox (center) image in a 16:9 frame  (16:9_4)	
4:3 Full frame image in a 4:3 frame  (4:3_8)	4:3 Full frame image in a 4:3 frame  (4:3_8)	4:3 Pillar-box image in 16:9 frame  (16:9_9)	
4:3 Full frame image in a 4:3 frame (use preferred 4:3_8 code instead)  (4:3_9)	4:3 Full frame image in a 4:3 frame  (4:3_9)	4:3 Pillar-box image in 16:9 frame  (16:9_9)	

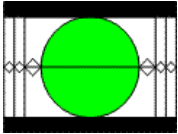
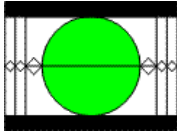
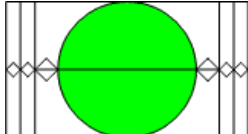
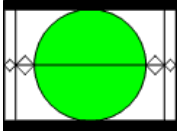
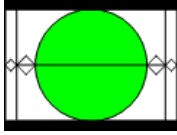
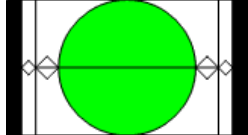
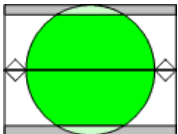
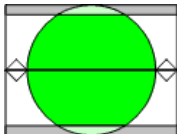
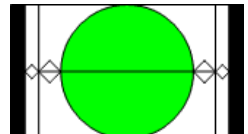
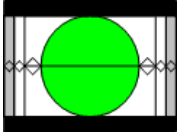
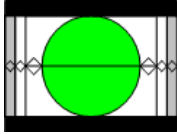
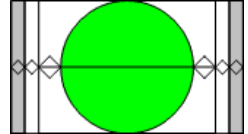
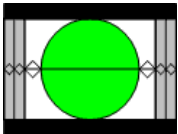
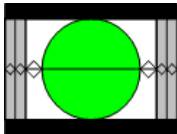
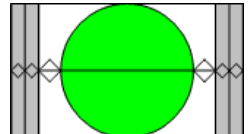
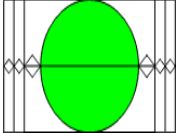
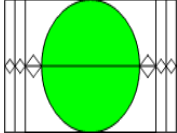
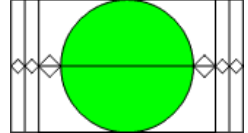
Input signal	4:3 monitor	Output signal	16:9 monitor
16:9 Letterbox image in 4:3 frame  (4:3_10)	16:9 Letterbox image in 4:3 frame  (4:3_10)	16:9 Full frame image in a 16:9 frame  (16:9_8)	
14:9 Letterbox image in a 4:3 frame  (4:3_11)	14:9 Letterbox image in a 4:3 frame  (4:3_11)	14:9 Pillar-box image in a 16:9 frame  (16:9_11)	
4:3 Image shoot and protect 14:9 in a 4:3 frame  (4:3_13)	4:3 Image shoot and protect 14:9 in a 4:3 frame  (4:3_13)	14:9 Pillar-box image in a 16:9 frame  (16:9_11)	
16:9 Letterbox image shoot and protect 14:9 in a 4:3 frame  (4:3_14)	16:9 Letterbox image shoot and protect 14:9 in a 4:3 frame  (4:3_14)	16:9 Image shoot and protect 14:9 in a 16:9 frame  (16:9_14)	
16:9 Letterbox image shoot and protect 16:9 in a 4:3 frame  (4:3_15)	16:9 Letterbox image shoot and protect 16:9 in a 4:3 frame  (4:3_15)	16:9 Image shoot and protect 14:9 in a 16:9 frame  (16:9_15)	
16:9 image shoot and protect 16:9 in a 4:3 frame (anamorphic)  (16:9_8)	16:9 image shoot and protect 16:9 in a 4:3 frame (anamorphic)  (16:9_8)	16:9 Full frame image in a 16:9 frame  (16:9_8)	

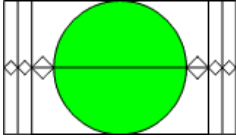
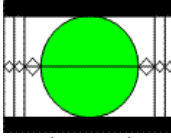
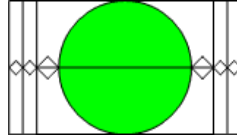
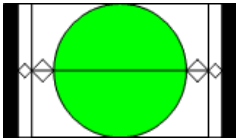
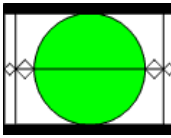
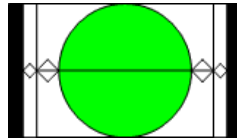
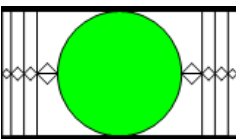
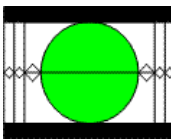
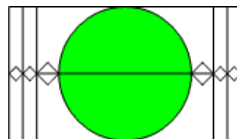
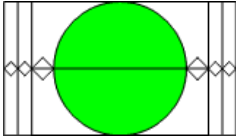
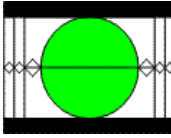
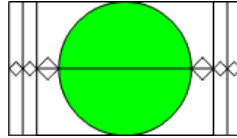
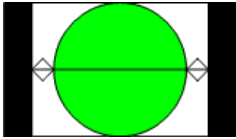
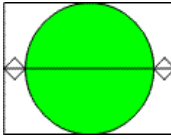
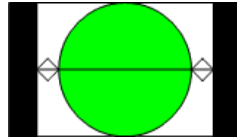
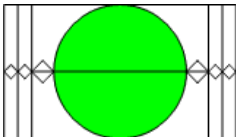
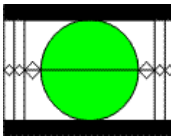
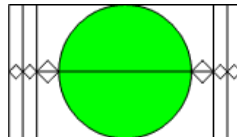
Input signal	4:3 monitor	Output signal	16:9 monitor
<p>16:9 Full frame image in a 16:9 frame (use preferred 16:9_8 flag instead)</p>  <p>(16:9_2)</p>	<p>16:9 Letterbox image in 4:3 frame</p>  <p>(4:3_10)</p>	<p>16:9 Full frame image in a 16:9 frame</p>  <p>(16:9_2)</p>	
<p>14:9 Pillar-box image in a 16:9 frame (use preferred 16:9_11 flag instead)</p>  <p>(16:9_3)</p>	<p>14:9 Letterbox image in a 4:3 frame</p>  <p>(4:3_11)</p>	<p>14:9 Pillar-box image in a 16:9 frame</p>  <p>(16:9_3)</p>	
<p>> 16:9 Letterbox (center) image in a 16:9 frame</p>  <p>(16:9_4)</p>	<p>16:9 Letterbox image in 4:3 frame</p>  <p>(4:3_4)</p>	<p>16:9 Protected Full frame image in a 16:9 frame</p>  <p>(16:9_4)</p>	
<p>16:9 Full frame image in a 16:9 frame</p>  <p>(16:9_8)</p>	<p>16:9 Letterbox image in 4:3 frame</p>  <p>(4:3_10) as shown here, or (4:3_8) as in box below</p>	<p>16:9 Full frame image in a 16:9 frame</p>  <p>(16:9_8)</p>	
<p>4:3 Pillar-box image in 16:9 frame</p>  <p>(16:9_9)</p>	<p>4:3 Full frame image in a 4:3 frame</p>  <p>(4:3_8)</p>	<p>4:3 Pillar-box image in 16:9 frame</p>  <p>(16:9_9)</p>	
<p>16:9 Protected Full frame image in a 16:9 frame</p>  <p>(16:9_10)</p>	<p>16:9 Letterbox image in 4:3 frame</p>  <p>(4:3_10)</p>	<p>16:9 Protected Full frame image in a 16:9 frame</p>  <p>(16:9_10)</p>	

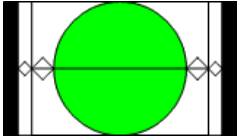
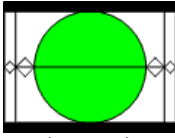
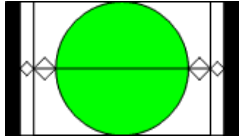
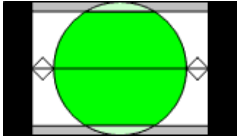
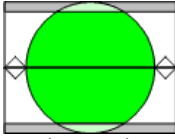
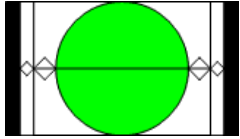
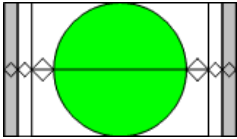
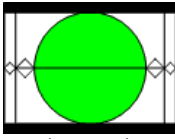
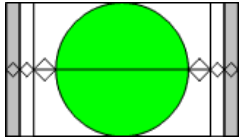
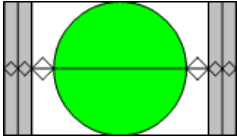
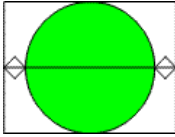
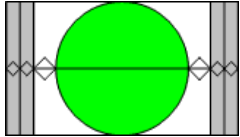
Input signal	4:3 monitor	Output signal 16:9 monitor
14:9 Pillar-box image in a 16:9 frame  (16:9_11)	14:9 Letterbox image in a 4:3 frame  (4:3_11)	14:9 Pillar-box image in a 16:9 frame  (16:9_11)
4:3 Pillar-box image Shoot and protect 14:9 in a 16:9 frame  (16:9_13)	4:3 Image shoot and protect 14:9 in a 4:3 frame  (4:3_13)	14:9 Pillar-box image in a 16:9 frame  (16:9_11)
16:9 Image shoot and protect 14:9 in a 16:9 frame  (16:9_14)	14:9 Letterbox image in a 4:3 frame  (4:3_11)	16:9 Image shoot and protect 14:9 in a 16:9 frame  (16:9_14)
16:9 Image shoot and protect 4:3 in a 16:9 frame  (16:9_15)	4:3 Full frame image in a 4:3 frame  (4:3_8)	16:9 Image shoot and protect 4:3 in a 16:9 frame  (16:9_15)

16 Annex 3: Installing the Optical Interface

Installing and removing the Fiber I/O interface cartridge requires special care. This annex describes the process.

The interface consists of two parts:

- A socket on the rear panel into which an SFP interface module is plugged
- An SFP (Small Form-factor Pluggable) module into which the optical fibers are plugged, and which incorporates the optical/electrical interface

Cautions and Warnings

	SFP Transmitter modules contain a class 1 laser, which emits invisible radiation whenever the module is powered up. Because the SFP is hot-swappable, the module may be powered up as soon as it is installed.
DO NOT LOOK INTO AN OPERATING SFP MODULE'S CONNECTORS, AS EYE DAMAGE MAY RESULT.	
	The SFP module is sensitive to electrostatic discharge (ESD).
	SFP modules are subject to wear, and their useful lifetime is reduced each time they are inserted or removed. Do not remove them more often than is absolutely necessary.
	Never remove or install an SFP module with the fiber optic cables connected. Damage to the cables could result.
	The presence of dust and debris can seriously degrade the performance of an optical interface. It is recommended that you insert a dust plug into the SFP module whenever a fiber optic cable is not connected.

Installing an SFP module

1. Make sure that the bale clasp lever is in the closed position



2. Slide the module straight into the socket, and push gently until it clicks into position.

Connecting the fiber optic cables

GUIDE TO INSTALLATION AND OPERATION

1. Remove the dust plug from the SFP module if present
2. Verify that the exposed end of the optical fiber in the LC connector is clean
 - Carefully remove any debris if necessary.
3. Plug the LC-terminated fiber optic cable into the SFP module

Removing the fiber optic cables

1. Grasp the LC fiber optic connector that is plugged into the SFP module, and pull it straight out to disengage the optical fiber from the SFP.
 - Never pull the fiber optic cable itself, as catastrophic damage may occur.
2. Insert a dust plug into the SFP module.

Removing the SFP module

1. Move the bale clasp lever to the open position.

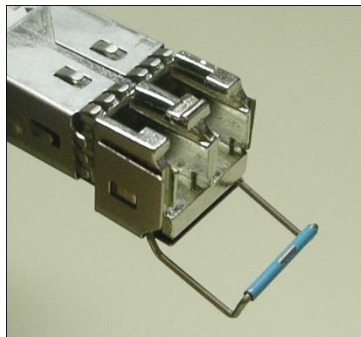

2. Grasp the SFP module between your thumb and forefinger, and pull it straight out of the slot.
 - Do NOT pull on the bale clasp lever to remove the module, as it is easily damaged
 - You may find that you need to wiggle the module, or perhaps push it into the slot a bit, before it will release and slide out.
3. Insert a dust plug into the SFP module.

17 Annex 4: SFP module and description

<i>Type</i>	<i>Model</i>	<i>Description</i>
RX	SFP-R-LC	Single fiber Rx (input) cartridge with LC/PC connector.
DUAL-RX	SFP-RR-LC	Dual fiber Rx (input) cartridge with LC/PC connector.
TX	SFP-T-S13-LC	Single fiber Tx (output) cartridge at 1310 nm with LC/PC connector.
DUAL-TX	SFP-TT-S13S13-LC	Dual fiber Tx (output) cartridge at 1310 nm with LC/PC connector.
RXTX	SFP-RT-S13-LC	Dual fiber Rx/Tx (input/output) cartridge 1310 nm with LC/PC connector.

18 Annex 5: Mounting bracket

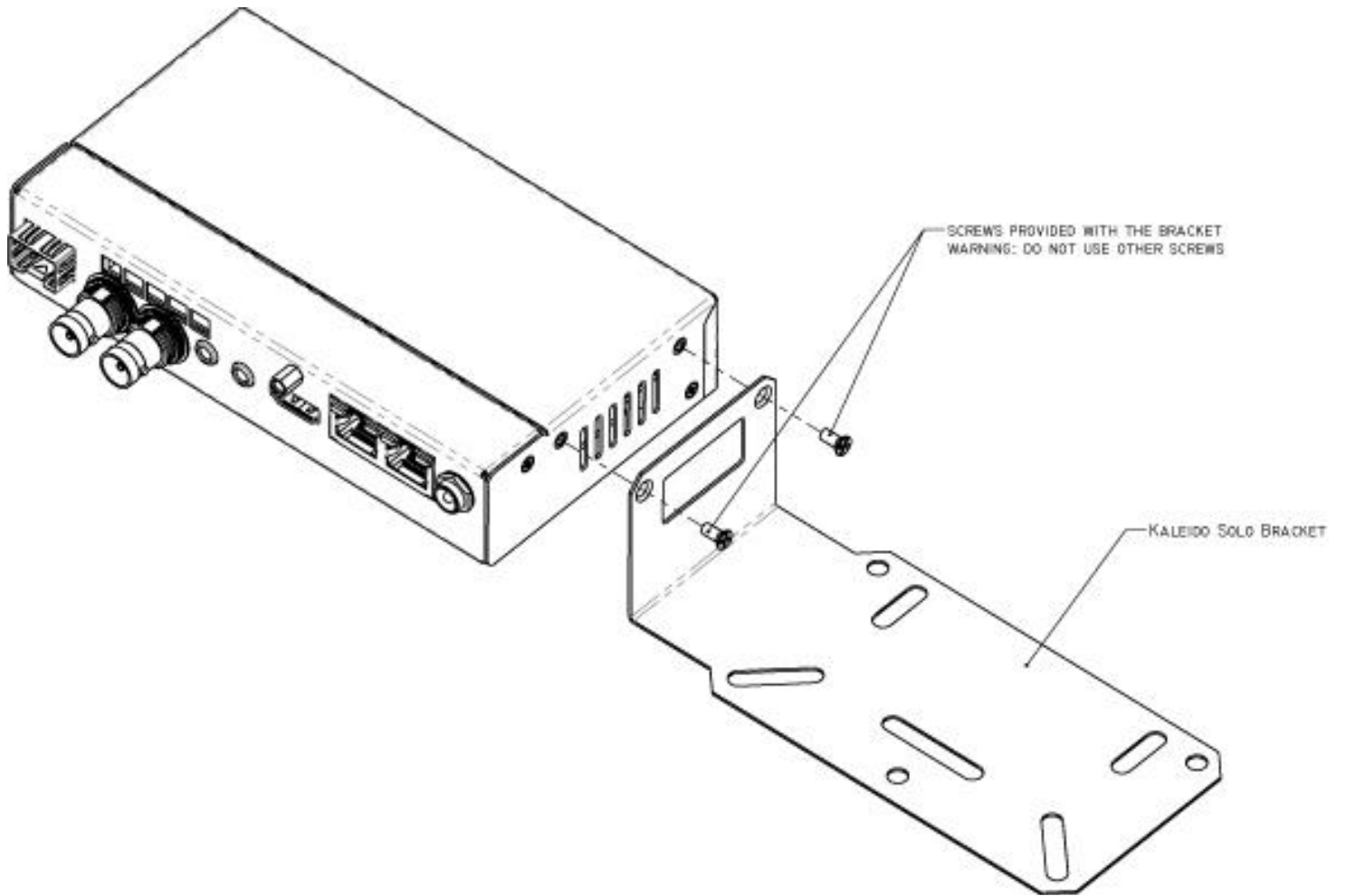

Do not use any screws other than the ones provided, or it may cause damage to the Kaleido-Solo.