



grass valley

A **BELDEN** BRAND

ICONTROL

CUSTOMIZED, END-TO-END FACILITY MONITORING

Supported Device Reference Guide

M226-0900-113

2018-02-28

www.grassvalley.com

Copyright and Trademark Notice

Copyright © 2001–2018, Grass Valley Canada. All rights reserved.

Belden, Belden Sending All The Right Signals, and the Belden logo are trademarks or registered trademarks of Belden Inc. or its affiliated companies in the United States and other jurisdictions. Grass Valley, Miranda, iControl, Kaleido-X, NVISION, and Densité are trademarks or registered trademarks of Grass Valley Canada. Belden Inc., Grass Valley Canada, and other parties may also have trademark rights in other terms used herein.

Warranty Policies

Warranty information is available from the Legal Terms and Conditions section of Grass Valley's website (www.grassvalley.com).

Title	iControl Supported Device Reference Guide
Part Number	M226-0900-113
Revision Date	2018-02-28, 17:37

toc

Table of Contents

1 Supported Devices	1
Overview	1
Routers	1
SNMP Devices	2
Special Devices	2
AKCP	2
sensorProbe8	2
Alpermann + Velte	2
Rubidium Universal Video Data Processor	3
APC	3
AP7900-Series Power Distribution Unit	3
NetBotz 200 Environmental Monitor	3
APC SMART UPS 2200 VA	3
Arris	3
BMR1200 Router (formerly <i>BigBand BMR1200</i>)	4
D5 Encoder	4
EGT Dual Pass Encoders (formerly <i>EGT Dual Pass Encoders</i>)	6
EGT HEMi Multi-Channel Edge Encoder (formerly <i>EGT HEMi</i>)	6
ASC Signal Corporation	7
APC400 Antenna Controller Unit	7
Avid	7
AirSpeed5000	7
Axon Digital Design	7
SDR08 — SD-SD Reclocking Distribution Amplifier (ASI/DVB-Compatible)	8
BigBand	8
Barco	9
China Electronics Technology Corp.	9
DAL3100 2x1 Audio Switch Driver	9
Cisco	10
D9032 MPEG-2 Encoder	11
D9036 Modular Encoding Platform	11
D9140 Advanced Multiplexer	11
D9190 Conditional Access Manager	11
D9228 Multiple Decryption Receiver	11
D9824 Advanced Multi-Decryption Receiver	12
D9828 Multiple Decryption Receiver	12
D9850 PowerVu Program Receiver	12
D9854 Receiver	12
D9858 Receiver Transcoder	12
DCM 9900 MPEG Processor	15

PowerVu Network Centre	20
Communications & Power Industries	23
TL22CI TWT Compact High Power Amplifier	23
Comtech EF Data Corp.	23
DM240XR High-Speed Digital Modulator	23
Crystal Solutions	28
CrystalVision 2000	28
Dantel	28
PointMaster	29
Webmon Edge/Matrix	29
Davicom	29
Davicom MAC PLUS	29
EGT	29
Dothill	29
DVB Control	29
EMC	30
NAS Network Attached Storage (formerly <i>Isilon NAS Network Attached Storage</i>)	30
Ensemble Designs.....	37
Avenue Modular Interfaces	37
Envivio	37
Ericsson	38
nCompass Control	38
RX1290 Multi-Format SD/HD IRD	38
RX8200-Series Advanced Modular Receiver	39
TT1260 Integrated Receiver Decoder	39
TT4130 Transport Stream Analyzer	39
Ericsson iPlex (<i>formerly SkyStream iPlex</i>)	39
Ericsson MediaPlex (<i>formerly SkyStream MediaPlex</i>)	39
ETV Module—CE Host Controller Card	39
ETV Module—CE-x H20 Encoder Card	40
Evertz 42	
500-Series Frame	42
500FC, 500DA	42
FC3405 Frame Controllers and Power Converters	43
3405FR-BNC	45
3000MVP Multiviewer Platform	48
7700-Series Frame	62
7767VIP HSN	62
7867VIPA-DUO	70
7707 VAT and VAR	71
Xenon Routing Switcher	71
EVS	71
XT/XS-Series Video Servers	71
Global Caché	71
GC-100 Network Adapter	71

Grass Valley	72
7600 SPG	73
Application Server	75
Grass Valley Karrera Classic & Panel	84
iTx HP DL370 G6 Server	95
iTX Supermicro	95
K2 Edge	104
Kaleido-Alto/Quad	109
Kaleido-K2	109
Grass Valley K2 SAN	109
K2 Solo Media Server	114
K2 Summit Production Client	118
Kaleido-X	121
Grass Valley NV9000 System Controller	122
Trinix	123
Vertigo XG	123
vFlex Multi-purpose HD Video Data Inserter (<i>formerly mfg'd by Softel</i>)	123
Harmonic	127
MaxLINK HOA 8030	127
ProStream 1000	127
ProView 7000/7100 Integrated Receiver-Decoder and Stream Processor	131
Harris (Leitch)	134
IconStatus Channel Branding	134
NetPlus M400 Integrated Receiver/Decoder	134
Panacea Routing Switcher	135
Hewlett Packard	138
Huawei	138
iManager I2000 NMS System	138
Hy-gain	138
DCU-1	138
IETF	139
HOST-RESOURCES MIB	139
Internet Control Message Protocol (ICMP)	139
MIB-II (RFC 1213)	139
RMON (RFC 2819)	139
IneoQuest	140
IVMS Video Management System	140
Singularus G1-T	141
Infotrend	143
SAN Storage	143
Intel	143
SR-Series Server Systems	143
International Datacasting Corp. (<i>formerly Logic Innovations</i>)	144
IPE-4000	144

RS-1100	145
TSx-2800	147
TSM-2800	149
IRTrans	149
LAN Controller XL Infrared Control System	150
Isilon	150
JDSU	150
VSA API v2	150
Lawo	151
Nova73 Digital Audio Matrix	151
Leitch	151
Met One Instruments	151
50.5 Wind Sensor	151
Microsoft	151
Interactive Program Guide	151
Windows 7	151
Windows® SNMP Agent	151
Miteq Inc.	152
Modulator 172138	152
NSU1 160061	155
Motorola	158
CAP-1000	159
CP7600 (formerly Terayon CP7600)	159
DM6400 CherryPicker (formerly Terayon DM6400)	159
DSR-4410	160
DSR-4440	160
DSR-4460	163
DSR-4500X	163
DSR-4520X	163
DSR-4550	163
DSR-6100	163
NE-2000 Network Encryptor	163
SE-6000	163
OM-1000 Modulator	164
SE-2000 Encoder	164
SE-1010/2000/2000IP	164
SE-4000/4010	164
SE-5000/5010	164
SmartStream Encryptor/Modulator (SEM)	164
SmartStream Transport Multiplexer (TMX 2010)	165
Net Insight	165
Nimbra680 Network Adaptor	165
Network Electronics Inc.	165
Nevion (Network Electronics Inc.)	165
Nevion Frame 166	

AAV-HD-DMUX-R HD-SDI Audio De-embedder (analog/digital audio)	168
AAV-HD-XMUX-T/R HD-SDI Audio De-embedder (analog/digital audio)	170
GYDA-SC Multi-frame System Controller	172
Multicon Nwork	172
Novelsat NS2000 Demodulator	172
NTT Electronics	178
NTT Electronics HVD 6100	178
NTT Electronics HVD 9100	186
PESA Switching Systems (QuStream Group)	192
Cheetah, Tiger, Jaguar, Cougar, Ocelot, Bobcat, and TDM3000 (SNM 35V3)	192
Phoenix Broadband Technologies (PBT)	192
ContactAgent GPI	192
Pinnacle Data Systems Inc. (PDSI)	193
DS130	193
Pro Broadband, Inc. (PBI)	193
DCH-4000P MPEG-2 SD IRD and Processor	193
QLogic	197
SAN Fiber Channel Switches	197
Quest Controls Inc.	197
TELSEC RM/WM-Series Controller	197
RGB Networks	197
BNP Broadcast Network Processor	197
MMC Modular Media Converter	198
SEP 48 Simulcast Edge Processor	198
Riedel	198
Artist Intercom System	198
Rohde & Schwarz	198
AEM100 Emission Multiplexer	198
Exciter	198
Ross Video Production Technology	199
openGear Frame and Modules	199
Samsung	199
ME-B Series Commercial Display Monitors	199
Screen Subtitling Systems Ltd.	199
Polistream Subtitling Product Family	199
SeaChange	200
SPOT Ad Insertion System	200
BML Servers	200
MCL Codec Servers	200
VOD Server	200
Sencore	200
MRD 3187B Receiver/Decoder	200
MRD 4400 Modular Receiver/Decoder	201
ServerTech	203
SkyStream	203
Snell	203

Snell Routers	203
Snell IQ Modular Interfaces	203
Softel	204
Sony	204
9-pin VTR Control (serial control)	204
SpectraLogic	204
BOA over T380 Enterprise Tape Library	204
Statmon	205
Axess Remote Control (RC) System	205
Studer	205
Studer Route 6000	205
Sumavision Technologies, Inc.	205
EMR-D8020	206
Tampa Microwave	209
Tandberg Television	210
Tektronix	210
Medius Application Manager	210
MTM400 MPEG TS Monitor	210
Sentry Video Quality Monitor	213
WFM 7200 Waveform Monitor	213
WVR-Series Waveform Rasterizer	213
Terayon	214
Thales Defense & Security, Inc.	214
VC1800 Carrier Monitoring System	214
TSL (Television Systems Ltd.)	214
MDU Mains Distribution Unit	214
T-VIPS	215
TVG-Series Gateways/CP-Series Processors	215
Videoframe Inc.	215
VF0037 GPI VNODE	215
Wegener Communications	216
DTV720 Transport Stream Multiplexer	216
XOR Media (formerly <i>SeaChange [Broadcast Division]</i>)	216
BML Servers	216
MCL Codec Servers	216
Contact Us	218

Supported Devices

The purpose of this document is to provide an overview of the devices supported by iControl, including specific details on available alarms and their parameters.

Overview

iControl is capable of monitoring and controlling a large and growing number of devices, that fall into three categories:

- routers
- SNMP devices
- special devices

The diagram below shows how each category interfaces with iControl:

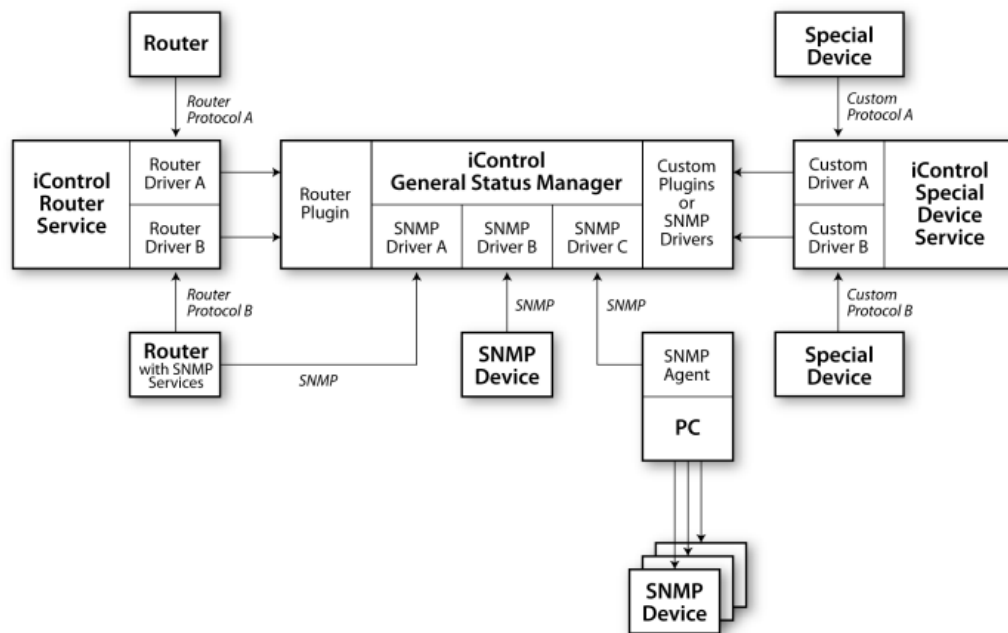

Routers

Router manufacturers implement proprietary protocols to enable control of their equipment. iControl's Router Service uses custom Grass Valley drivers to communicate with various routers using their native protocol. In addition to managing router control, the iControl Router Service is also able to publish router status and other information to the iControl GSM's router

plug-in. This plug-in is responsible for collecting, displaying, and updating router status in the GSM.

Some routers are also SNMP-enabled, and can send alarms to the iControl GSM. A specific SNMP driver is available for each router type.

SNMP Devices

This broad category covers any hardware or software that is able to send SNMP traps. For each supported device, an SNMP driver exists that enables some or all of the available SNMP parameters to be captured and displayed in the GSM.

In some cases, iControl interfaces to a software application that itself is used to manage a distinct set of equipment. The third party software, running on a PC or other hardware controller, usually has an SNMP agent that can be configured to send status and/or alarm messages. For each such agent, an SNMP driver exists that enables some or all of the available SNMP parameters to be captured and made available via the GSM.

Special Devices

Where particularly complex devices are to be monitored by iControl, a Special Device service exists to manage the flow of information. The status and alarm information from these devices may use SNMP, HTTP or any of a number of other protocols. Custom drivers are available for these multi-protocol devices, enabling custom GUI displays to be created within iControl.

AKCP

Ordering information

Hardware	New in iControl version	GSM plug-in name	Order number
sensorProbe8	4.30	SNMP – AKCP sensorProbe8	IC-SNMP-138

sensorProbe8

The AKCP sensorProbe8 safeguards your infrastructure, resources and investment from external disaster before it happens. The sensorProbe8 is a high-speed, accurate and intelligent monitoring device and a completely embedded host with a proprietary Linux like OS which includes TCP/IP stack, a built in web-server and full Email and SNMP functionality.

Alpermann + Velte

Ordering information

Hardware	New in iControl version	GSM plug-in name	Order number
Rubidium Universal Video Data Processor		SNMP – Alpermann+Velte Rubidium	IC-SNMP-091

Rubidium Universal Video Data Processor

Modular multi-format video time code and metadata processor.

APC

Ordering information

Hardware	New in iControl version	GSM plug-in name	Order number
AP7900-Series Power Distribution Unit		SNMP – APC AP7900	IC-SNMP-095
NetBotz 200 Environmental Monitor	5.00	SNMP – APC NetBotz200	IC-SNMP-197
APC SMART UPS 2200 VA	4.30	SNMP – APC Smart-UPS 2200	IC-SNMP-158

AP7900-Series Power Distribution Unit

Standalone 19-inch rack-mountable data-line surge suppression for network, telecommunication and PC system protection.

NetBotz 200 Environmental Monitor

Over-the-network environmental monitor (humidity, temperature, door contact, dry contact, etc.).

APC SMART UPS 2200 VA

The APC Smart-UPS 2200 VA (tower or rack unit) protects critical data by supplying reliable, network-grade power in either traditional tower or rack- optimized convertible form factor.

Arris

Ordering information

Hardware	New in iControl version	GSM plug-in name	Order number
BMR1200 Router (formerly BigBand BMR1200)		SNMP – BigBand BMR1200	IC-SNMP-153
D5 Encoder	6.03	SNMP – Arris D5	IC-SNMP-265
EGT Dual Pass Encoders (formerly EGT Dual Pass Encoders)	4.40	SNMP – Arris EGT Dual-Pass Encoders	IC-SNMP-194
EGT HEMi Multi-Channel Edge Encoder (formerly EGT HEMi)	4.40	SNMP – Arris EGT HEMI Multi-Channel Edge Encoder	IC-SNMP-193

BMR1200 Router (formerly *BigBand BMR1200*)

The Arris Broadband Multimedia-Service Router BMR1200 is a platform for network delivery of video services.

D5 Encoder



The ARRIS D5™ Universal Edge QAM (UEQ) is a unique class of IP edge network device that enables delivery of a wide variety of multimedia content in a redundant, modular, and cost-effective package. It supports a complete QAM-Sharing solution with simultaneous delivery of any combination of Video-On-Demand, Digital Broadcast, Switched Digital Video (SDV) Services, and DOCSIS downstream data using the Modular Cable Modem Termination System (M-CMTS™) architecture. Operators are saved from the capital and operational expense burden of having to replace or retrofit non-compliant Edge QAMs when transitioning to advanced multimedia services. The ARRIS D5 UEQ offers extensive, industry-leading, remote or locally-attached graphical and command line tools for operations management. All management options provide complete access control to all elements of the D5. For those operators seeking additional user-level access control, Radius and TACACS+ authentication is offered as well.

Notes

- It is not possible to perform a walk of the device using the usual way. The device will not return everything.
 - The device uses standard MIBs to contain interface and QAM information.
-

See the following tables for device support details:

- on page 5
- on page 5
- on page 6

Health monitoring and text alarms

Alarm name	Type	Further details	URI format
Communication Status	Device	Indicates communication status with the device	{baseuri}commStatus
Device Reboot	Device	Indicates reboot status of the device.	{baseuri}powerCycle
QAM MPEG Lock ({qamport})	Service	QAM MPEG lock for a given interface number or QAM name	{baseuri}d5QamRFSigQMpegLock{qamport}
QAM Ts ID ({qamport})	Service	QAM transport stream ID tied to this QAM	{baseuri}d5vQamTransportStreamID{qamport}
QAM Error ({qamport})	Service	QAM error for a given interface number or QAM name	{baseuri}d5vQamError{qamport}
QAM Stream Status ({qamport})	Service	QAM stream status for a given interface number or QAM name	{baseuri}d5vQamStreamStatus{qamport}
TS PID Error {tsip}:{tsudp}	Service	Stream PID error	{baseuri}d5MpegMgtProgPidErrorTrap{tsudp}.{tsip}
TS Lost {tsip}:{tsudp}	Service	Stream Lost	{baseuri}d5vIpStreamLost{tsudp}.{tsip}
TS Status {tsip}:{tsudp}	Service	Stream Status	{baseuri}d5vIpStreamStatus{tsudp}.{tsip}
TS Unavail {tsip}:{tsudp}	Service	Stream Unavailable	{baseuri}d5vIpStreamUnAvail{tsudp}.{tsip}
PRG Error {tsip}:{tsudp}:{tsprg}	Service	Program Error	{baseuri}d5vIpProgramError{tsudp}.{tsip}.{tsprg}
PRG Overflow {tsip}:{tsudp}:{tsprg}	Service	Program Overflow	{baseuri}d5MpegMgtProgOverflowTrap{tsudp}.{tsip}.{tsprg}
PRG Oversubscribe {tsip}:{tsudp}:{tsprg}	Service	Program Oversubscribe	{baseuri}d5MpegMgtProgOversubsTrap{tsudp}.{tsip}.{tsprg}
PRG Underflow {tsip}:{tsudp}:{tsprg}	Service	Program Underflow	{baseuri}d5MpegMgtProgUnderflowTrap{tsudp}.{tsip}.{tsprg}

Certain parameters are configurable, as follows:

Configurable parameters

Name	Parameters object key	Description/Notes	Default value
Alarm Path	alamPath	Path under which alarms are created in IC Navigator.	"GrassValley/K2_Summit (<IP>)"
Poll Interval	pollInterval	Period between repeated SNMP polls to the device.	30 seconds
Retries	retries	Number of times to retry after a failed SNMP poll.	1 retry
Timeout	timeout	Number of seconds to wait for a response before declaring SNMP poll failed.	3 seconds

Configurable parameters (*Continued*)

Name	Parameters object key	Description/Notes	Default value
Read Community	<code>readCommunity</code>	SNMP read community string (password).	"public"
adjustQAMMIBIndex	<code>adjustQAMMIBIndex</code>	The mib index is off by 1. This is a bug in the device that may be fixed in a future release. Therefore we have a way here to enable/disable that adjustment.	1
useQamName	<code>useQamName</code>	This is a method of creating an alarm using client-supplied QAM names instead of the default method of using the QAM interface. QAM names look like this: QAM 1-1.1	true
signalFocedSeverityText	<code>signalForcedSeverityText</code>	Force all signal alarms to a given severity level.	""
healthForcedSeverityText	<code>healthForcedSeverityText</code>	Force all health alarms to a given severity level.	""

The alarm parameters in iC Web are as follows:

iC Web alarm parameters

Parameter	Description
<code>qamport</code>	For QAM alarms. Can be interface number or QAM name depending on parameter <code>useQamName</code> .
<code>tsudp</code>	Transport stream UDP port. Used for stream alarms.
<code>tsip</code>	Transport stream multicast ip address. Used for stream alarms.
<code>tsprg</code>	Transport stream program number. used for program alarms.

EGT Dual Pass Encoders (formerly *EGT Dual Pass Encoders*)

The Arris dual-pass encoders are two-pass encoders with analog and digital SDI inputs and simultaneous ASI and IP output.

EGT HEMi Multi-Channel Edge Encoder (formerly *EGT HEMi*)

The Arris EGT HEMi is a multi-channel encoder with IP-to-IP, and ASI-to-IP. It provides data on audio, video and program services, as well as a stream information.

ASC Signal Corporation

Ordering information

Hardware	New in iControl version	GSM plug-in name	Order number
APC400 Antenna Controller Unit		SNMP – APC400 Antenna Controller	IC-SNMP-220

APC400 Antenna Controller Unit

The APC400 Antenna Control Unit is an antenna controller that provides basic point, maintenance, and optional tracking functions for small and medium-sized earth station antennas. The APC400 provides the user with control over basic motorization kits for earth station satellites by utilizing a simple liquid crystal display (LCD) front panel interface and powerful software protocol options. The software protocols can be manipulated through remote control.

Avid

Ordering information

Hardware	New in iControl version	GSM plug-in name	Order number
AirSpeed5000	5.00	SNMP – Avid Airspeed5000	IC-SNMP-221

AirSpeed5000

The AirSpeed 5000 server takes on a wide range of applications for broadcasters of any size. Building on a legacy of innovative workflow-enabling servers, AirSpeed 5000 adds cost-efficient play to air capability, slow motion playback and support for third party editing systems. Peerless Avid workflow integration, open design, and codec agility provide the ease, speed, and flexibility essential for long term broadcast success.

Axon Digital Design

The Axon frames RRS08 (version 34) and RRS18 (version 34) as well as many of Axon's family of modular interfacing and conversion cards are supported by iControl, as follows:

- **2HX10** (version 21): Dual-channel HD/SD integrity-checking probe
- **CDV29** (version 03): Analog distribution amplifier with 9 outputs and synapse reference points
- **DLA41** (version 06): 8-channel (5.1/2.0) digital audio upmixer/downmixer - with Quad Speed audio bus (based on Linear Acoustic algorithms)
- **DLA42** (version 05): 8-channel digital audio loudness control unit

- **DLA43** (version 06): 8-channel (5.1/2.0) digital audio loudness control - with Quad Speed audio bus (based on Linear Acoustic algorithms)
- **GDR26** (version 07): 3Gb/s, HD, and SD dual input distribution amplifier with 3 reclocked outputs per channel (ASI/DVB compatible)
- **HDR07** (version 04): HD/SD reclocking distribution amplifier
- **HEP10** (version 100): HD-, SD-embedded domain Dolby E-to-PCM decoder with audio shuffler (3Gb/s upgradeable)
- **HPD13** (version 100): HD-, SD-embedded domain PCM+AD to Dolby Digital (Plus) encoder with audio shuffler and audio description processor
- **HRB99** (version 080): HD/SD digital audio de-embedder, re-embedder, embedded domain shuffler with S2020 metadata insertion
- **HXT10** (versions 300, 330, 390): Dual HD input frame synchronizer, down converter, embedder, CVBS encoder
- **PBS03** (version 06): Dual channel relay-based backup switcher with signal integrity checking
- **SDN09** (version 07): SD-SDI Non-reclocking dual channel distribution amplifier (ASI/DVB compatible)
- **SDN08** (version 07): SD-SDI Non-reclocking distribution amplifier (ASI/DVB compatible)

Ordering information

Hardware	New in iControl version	GSM plug-in name	Order number
HXH41 HD Converter		SNMP – Axon HXH41	IC-SNMP-147
RRS08 — Rack Controller for SFR08	4.30	SNMP – Axon RRS08, RRS18, PBS03, SDR08	IC-SNMP-144
RRS18 — Rack Controller for SFR18			
PBS03 — Dual Channel Relay-Based Back-Up Switcher			
SDR08 — SD-SD Reclocking Distribution Amplifier (ASI/DVB-Compatible)			

SDR08 — SD-SD Reclocking Distribution Amplifier (ASI/DVB-Compatible)

The SDR series provide a range of distribution amplifiers with flexible input and output variations. The SDR08 reclocks the input signal. The SDR08 is a 1 to 8 distribution amplifiers compatible with ASI/DVB.

BigBand

Please see [Arris on page 3](#).

Barco

Ordering information

Hardware	New in iControl version	GSM plug-in name	Order number
Hydra Monitor Wall	4.30	SNMP – BARCO Hydra	IC-SNMP-140

China Electronics Technology Corp.

Ordering information

Hardware	New in iControl version	GSM plug-in name	Order number
DAL3100 2x1 Audio Switch Driver	6.03	SNMP – CETC DAL3100	IC-SNMP-256

DAL3100 2x1 Audio Switch Driver

Alarms

Alarm name	Type	Polling or Trap	MIB point	Further details
------------	------	-----------------	-----------	-----------------

--- Main card alarms ---

Input A Level Status	Status	Polling	<code>myCard1ALevel1Status</code>	B channel level is higher than A channel level 12dB
Input B Level Status	Status	Polling	<code>myCard1BLevel1Status</code>	B channel level is higher than A channel level 12dB
Current Channel	Status/Text	Polling	<code>myCard1CurrentChannel</code>	The Card's Current Channel
Switch Mode	Text	Polling	<code>myCard1SwitchMode</code>	The Card's switch status.
Active Alarm	Status	Polling	<code>myCard1Alarm</code>	Whether or not the card 1 has an alarms.

--- Other card alarms ---

Level Threshold	Text	Polling	<code>myCard1LevelThreshold</code>	The Card's Level Threshold
Switch Delay	Text	Polling	<code>myCard1SwitchDelay</code>	The Card's switch delay time
Controller	Text	Polling	<code>myCard1SwitchControl</code>	The Card is Controlled by which user
Connection Status	Text	Polling	<code>myCard1ConnectStatus</code>	Whether or not DAL-3100A has found her SystemConnect
Input B 6dB Above Input A	Status	Polling	<code>myCard1BPriorA6dB</code>	B channel level is higher than A channel level 6dB

Alarms (Continued)

Alarm name	Type	Polling or Trap	MIB point	Further details
Input B 12dB Above Input A	Status	Polling	<code>myCard1BPriorA12dB</code>	B channel level is higher than A channel level 12dB

--- Non-card alarms ---

PSU A Status	Status	Polling	<code>myPowerAStatus</code>	Whether or not Power A is normal.
PSU B Status	Status	Polling	<code>myPowerBStatus</code>	Whether or not Power B is normal.
Communication Status	Status	Polling	<code>commStatus</code>	~

Configurable parameters

Parameter	Description
<code>AlarmPath</code>	Used to set the Alarm prefix. Default value: <code>PBI</code> Could be replaced by <code>IRD</code> to have legacy plug-ins tree look-like.
<code>pollInterval</code>	Poller interval in seconds. Overwrite the default interval of 20 seconds.
<code>retries</code>	If an SNMP request times out, this defines the number of retries to be performed. Default: <code>1</code>
<code>timeout</code>	Delay in seconds before declaring a timeout in the current SNMP request.
<code>uniqueID</code>	An extra identifier to be assigned to the plug-in to differentiate its alarms from the other plug-in of the same type. The <code>uniqueID</code> should be part of the URI.
<code>readCommunity</code>	SNMP read community string. Use for SNMP polling. Default value: <code>public</code>
<code>writeCommunity</code>	SNMP write community string. Use to set SNMP variable. Default value: <code>private</code>
<code>nbConverter</code>	Number of converter to monitor. By default, monitor all converters (12 + 1 backup)
<code>cvSelWaitTime</code>	Defines the number of milliseconds to wait after the converter selection. Default: <code>200 ms</code>

Cisco

Ordering information

Hardware	New in iControl version	GSM plug-in name	Order number
D9032 MPEG-2 Encoder		SNMP - Cisco D9032	IC-SNMP-132
D9036 Modular Encoding Platform	4.40	SNMP - Cisco D9036	IC-SNMP-177

Ordering information (*Continued*)

Hardware	New in iControl version	GSM plug-in name	Order number
D9140 Advanced Multiplexer	6.02	SNMP – Cisco/SA D9140	IC-SNMP-249
D9190 Conditional Access Manager	6.02	SNMP – Cisco/SA D9190	IC-SNMP-250
D9228 Multiple Decryption Receiver		SNMP – Cisco D9228	IC-SNMP-171
D9828 Multiple Decryption Receiver		SNMP – Cisco D9828	IC-SNMP-032
D9850 PowerVu Program Receiver		SNMP – Cisco D9850	IC-SNMP-024
D9854 Receiver		SNMP – Cisco D9854	IC-SNMP-169
D9858 Receiver Transcoder	6.04	SNMP – Cisco D9858	IC-SNMP-126
DCM 9900 MPEG Processor		SNMP – Cisco DCM9900	IC-SNMP-116
PowerVu Network Centre	6.02	SNMP – Cisco PowerVu Network Controller	IC-SNMP-237

D9032 MPEG-2 Encoder

D9036 Modular Encoding Platform

The D9036 is a modular encoding platform, providing multi-resolution, multi-format encoding for applications requiring high levels of video quality.

D9140 Advanced Multiplexer

Cisco's PowerVu® Model D9140 Advanced Multiplexer combines signals and encrypts data with optional standards. The PowerVu Advanced Multiplexer combines up to 24 MPEG-2 transport streams, encrypts each individual service, and provides three identical MPEG-2 transport outputs to Cisco's PowerVu Model D9390 Advanced Modulator or various other modulators for cable and terrestrial applications. Transport packets are transferred from each encoder or each transport stream receiving device to the multiplexer using a DVB-ASI interface. Communication control between the multiplexer and the PowerVu Network Centre is facilitated via an Ethernet link.

D9190 Conditional Access Manager

The Cisco® PowerVu® D9190 Conditional Access Manager (PCAM) is one of the PowerVu next generation system core components. The D9190 is used for encrypting services with PowerVu CA (PCA), and is designed for use with the Digital Content Manager to provide a functional replacement for the PowerVu D9140 Advanced Multiplexer.

D9228 Multiple Decryption Receiver

The PowerVu D9228 receives, demodulates, and decrypts multiple encrypted MPEG-2/DVB digital programs delivered via satellite or DVB-ASI interface.

D9824 Advanced Multi-Decryption Receiver

The PowerVu D9828 receives, demodulates, and decrypts multiple encrypted MPEG-2/DVB digital programs from satellite or terrestrial sources, and outputs decoded composite video and balanced audio for monitoring purposes.

D9828 Multiple Decryption Receiver

The PowerVu D9828 receives, demodulates, and decrypts multiple encrypted MPEG-2/DVB digital programs from satellite or terrestrial sources, and outputs decoded composite video and balanced audio for monitoring purposes.

D9850 PowerVu Program Receiver

The PowerVu D9850 decodes 4:2:0 video for satellite content distribution applications. It can receive digitally encrypted video, audio, utility data, and Vertical Blanking Interval (VBI) data.

D9854 Receiver

D9858 Receiver Transcoder



The Cisco®D9858 Advanced Receiver Transcoder delivers MPEG-4 high definition (HD) services to MPEG-2 cable television (CATV) headends. The Cisco D9858 extends the distribution options for MPEG-4 Advanced Video Coding (AVC) HD from MPEG-4 only environments to existing MPEG-2 networks. Support for simultaneous dual-channel decryption and transcoding provides density for locations requiring more than a single channel. The D9858 can also be used to provide a down-converted standard definition (SD) MPEG-2 program instead of one or both of the available HD transcoded programs. Video and two audio outputs are available for analog down conversion for one of the decrypted incoming MPEG-4 HD programs.

See the following tables for device support details:

- on page 13
- on page 15

Alarms provided by the driver

Alarm name	Type	Poll/ Trap	URI format	MIB node name	OID
Average Temperature	Text	Poll	saHealthMonitorBoardAvgTemp	saHealthMonitorBoardAvgTemp	.1.3.6.1.4.1.1429.2.2.6.5.38.2.3
Communication Status	Status	Poll	commStatus		
Current Temperature	Text	Poll	saHealthMonitorBoardCurrentTemp	saHealthMonitorBoardCurrentTemp	.1.3.6.1.4.1.1429.2.2.6.5.38.2.1
Device Reboot	Status	Poll	powerCycle		
Fan 1 RPM	Text	Poll	saHealthMonitorFan1RPM	saHealthMonitorFan1RPM	.1.3.6.1.4.1.1429.2.2.6.5.38.2.8
Fan 2 RPM	Text	Poll	saHealthMonitorFan2RPM	saHealthMonitorFan2RPM	.1.3.6.1.4.1.1429.2.2.6.5.38.2.9
Fan 3 RPM	Text	Poll	saHealthMonitorFan3RPM	saHealthMonitorFan3RPM	.1.3.6.1.4.1.1429.2.2.6.5.38.2.10
Fan 4 RPM	Text	Poll	saHealthMonitorFan4RPM	saHealthMonitorFan4RPM	.1.3.6.1.4.1.1429.2.2.6.5.38.2.11
Fan 5 RPM	Text	Poll	saHealthMonitorFan5RPM	saHealthMonitorFan5RPM	.1.3.6.1.4.1.1429.2.2.6.5.38.2.12
Fan 6 RPM	Text	Poll	saHealthMonitorFan6RPM	saHealthMonitorFan6RPM	.1.3.6.1.4.1.1429.2.2.6.5.38.2.13
Fan 7 RPM	Text	Poll	saHealthMonitorFan7RPM	saHealthMonitorFan7RPM	.1.3.6.1.4.1.1429.2.2.6.5.38.2.14
Max Temperature	Text	Poll	saHealthMonitorBoardMaxTemp	saHealthMonitorBoardMaxTemp	.1.3.6.1.4.1.1429.2.2.6.5.38.2.2
Boot Version	Text	Poll	saAboutBootVer	saMacInfoTable	.1.3.6.1.4.1.1429.2.2.6.5.4.1
Current Version	Text	Poll	saAboutCurrentVer	saMacInfoTable	.1.3.6.1.4.1.1429.2.2.6.5.4.1
Main PCB board version	Text	Poll	saAboutBoard	saMacInfoTable	.1.3.6.1.4.1.1429.2.2.6.5.4.1
Network Gateway	Text	Poll	saIpdataCurDefaultGateway	saIPConfigTable	.1.3.6.1.4.1.1429.2.2.6.5.6.1.1
Network IP	Text	Poll	saIpdataCurIpAddr	saIPConfigTable	.1.3.6.1.4.1.1429.2.2.6.5.6.1.1
Network MAC	Text	Poll	saIpdataMacAddr	saIPConfigTable	.1.3.6.1.4.1.1429.2.2.6.5.6.1.1
Network Mask	Text	Poll	saIpdataCurNetworkMask	saIPConfigTable	.1.3.6.1.4.1.1429.2.2.6.5.6.1.1
Product ID	Text	Poll	saAboutProductId	saMacInfoTable	.1.3.6.1.4.1.1429.2.2.6.5.4.1
Safe Version	Text	Poll	saAboutSafeVer	saMacInfoTable	.1.3.6.1.4.1.1429.2.2.6.5.4.1

Alarms provided by the driver (Continued)

Alarm name	Type	Poll/ Trap	URI format	MIB node name	OID
MIRA (null) Authorized	Text	Poll	Service_null/saCaAuthorized	saCaEntry	.1.3.6.1.4.1.1429.2.2.6 .5.14.1
MIRA Authorized	Status	Poll	saCaAuthorized0	saCaEntry	.1.3.6.1.4.1.1429.2.2.6 .5.14.1
MIRA Index	Text	Poll	channelIndex0	saCaEntry	
QWER Authorized	Status	Poll	saCaAuthorized2	saCaEntry	.1.3.6.1.4.1.1429.2.2.6 .5.14.1
QWER Encrypted	Status	Poll	saCaEncrypted2	saCaEntry	.1.3.6.1.4.1.1429.2.2.6 .5.14.1
QWER Index	Text	Poll	channelIndex2	saCaEntry	
QWER Scrambled	Status	Poll	saCaScrambled2	saCaEntry	.1.3.6.1.4.1.1429.2.2.6 .5.14.1
ZWXC Authorized	Status	Poll	saCaAuthorized1	saCaEntry	.1.3.6.1.4.1.1429.2.2.6 .5.14.1
ZWXC Encrypted	Status	Poll	saCaEncrypted1	saCaEntry	.1.3.6.1.4.1.1429.2.2.6 .5.14.1
ZWXC Index	Text	Poll	channelIndex1	saCaEntry	
ZWXC Scrambled	Status	Poll	saCaScrambled1	saCaEntry	.1.3.6.1.4.1.1429.2.2.6 .5.14.1
QWER (32767) Authorized	Status /Text	Poll	saCaAuthorized	saCaEntry	.1.3.6.1.4.1.1429.2.2.6 .5.14.1
QWER (32767) Encrypted	Status /Text	Poll	saCaEncrypted	saCaEntry	.1.3.6.1.4.1.1429.2.2.6 .5.14.1
QWER (32767) Scrambled	Status /Text	Poll	saCaScrambled	saCaEntry	.1.3.6.1.4.1.1429.2.2.6 .5.14.1
L-Band Input	Text	Poll	LBandInput	saSatSigLbandFreq	.1.3.6.1.4.1.1429.2.2.6 .5.11.1.1.12
AFC Level	Text	Poll	saFeAfcLevel1	saSatSigAfc	.1.3.6.1.4.1.1429.2.2.6 .5.11.1.1.7
ASI Lock	Status	Poll	saAsiLock	saInputStatusAsiLock	.1.3.6.1.4.1.1429.2.2.6 .5.11.1.2.2
Audio bitrate 1	Text	Poll	saAudioBitRate1	saAudioStatusBitRate	.1.3.6.1.4.1.1429.2.2.6 .5.23.2.1.3
Audio bitrate 2	Text	Poll	saAudioBitRate2	saAudioStatusBitRate	.1.3.6.1.4.1.1429.2.2.6 .5.23.2.1.3
Corrected errors	Text	Poll	saFeCorrErrorCount		
LNB Power Supply Status	Text	Poll	saFeLnbPsStatus	saSatSigLnbPsStatus	.1.3.6.1.4.1.1429.2.2.6 .5.11.1.1.18
RF Lock	Status	Poll	saFeRfLock	saSatSigRfLock	.1.3.6.1.4.1.1429.2.2.6 .5.11.1.1.10

Alarms provided by the driver (Continued)

Alarm name	Type	Poll/Trap	URI format	MIB node name	OID
Satellite Lock	Text	Poll	saSatLock	saInputStatusSatLock	.1.3.6.1.4.1.1429.2.2.6 .5.11.1.2.3
Transport Error	Status	Poll	saTransportError	saInputStatusTransportError	.1.3.6.1.4.1.1429.2.2.6 .5.11.1.2.9
Uncorrected errors	Text	Poll	saFeUncorrErrorCount		
Video bitrate	Text	Poll	saVideoBitrate	saVideoBitRate	.1.3.6.1.4.1.1429.2.2.6 .5.20.1.7

Certain parameters are configurable, as follows:

Configurable parameters

Name	Description/Notes	Default value
pollInterval	Poller interval in seconds. Overwrite the default interval.	120
retries	If an SNMP request times out, this defines the number of retries to be performed.	1
timeout	Delay in seconds before declaring a timeout in the current SNMP request.	5
uniqueID	An extra identifier to be assigned to the plugin to differentiate its alarms from the other plugin of the same type. The uniqueID should be part of uri.	
readCommunity	SNMP read community string, used for SNMP polling.	public
writeCommunity	SNMP write community string, used to send SNMP-set commands.	public
lBandLevelThreshold		-45
interCommandDelay		50
setDelay		100
totalgetOIDs		0

DCM 9900 MPEG Processor



The Cisco® DCM Series D9900 Digital Content Manager (DCM) MPEG Processor is a compact 2RU platform capable of processing a high number of MPEG video streams.

See the following for device support details:

- on page 16
- on page 20
- on page 20

Alarms

Alarm name	Type	Polling or trap?	MIB point	Description
Card Not Operational	Status	Trap		Raise when the communication between the main board of the DCM and the interface card is down.
Co-processor Not Operational	Status	Trap		Raise when the communication between the interface card and the Co-Processor Card is down.
Device is in Service Mode	Status	Trap		Raise when the Ethernet capturing process is started or when the trace level for card trace logs are set to All, Minor, or Major.
Device Mode	Text	No polling, no trap, internal variable		
Device Operational Failure	Status	Trap		Raise when a "Card Not Operational" alarm is generated.
Fan Failure	Status	Trap		Raise when a fan is malfunctioning.
Heartbeat Protocol Error	Status	Trap		Raise when the UDP port used by the Heartbeat Protocol for standalone device backup is occupied.
Link Loss	Status	Trap		Raise if link is down between the source device and the DCM or between the DCM and the destination device.
Low memory	Status	Trap		Raise if less the 50 MB of the available memory is free.
NTP Offset	Status	Trap		Raise if the DCM is not synchronized with a NTP server or if the time difference between DCM and the NTP server exceeds a particular (by default 15 ms).
Operational Temperature	Status	Trap		Raise if the device temperature exceeds 65° C (149° F).
Power Up	Status	Trap		Generate after powering up or rebooting the DCM.

Alarms (Continued)

Alarm name	Type	Polling or trap?	MIB point	Description
PS 1 Failure	Status	Trap		This alarm is generated when the power supply unit in slot PS1 is failing.
PS 2 Failure	Status	Trap		This alarm is generated when the power supply unit in slot PS2 is failing.
Requested PID could not be allocated	Status	Trap		Raise When a particular component for scrambling purposes could not be allocated
Service Level Failover Configured	Text			

--- Health monitoring alarms ---

Device Communication	Status	Health Polling	/	Raise a critical condition if the device stops responding to polling for a time period defined by pollinterval X retries.
Device Restart	Status	Health Polling	/	Raise a minor condition based on the value of sysUpTime read is smaller compared to last reading.
System uptime	Text	Health Polling	sysUpTime (RFC1213-MIB)	Display the uptime of the system.

--- Input > Board alarms ---

Unreferenced PIDs Maximum Number Reached	Status	Trap		Raise when the number of incoming unreferenced components exceeds 500.
--	--------	------	--	--

--- Input > Board > Port > IP address alarms ---

CC Error	Status	Trap		Raise if the packets with a particular PID value were lost, or when they appeared in an incorrect order, or appeared more than twice.
FEC L/D Error	Status	Trap		Raise when a transport stream enters the device with forward error correction (FEC) scheme L x D > 100 for a GbE Interface Card or > 1500 for an IP Video Gateway Card
Input TS UDP Failover	Status	Fast and slow polling, Trap		Generated when we change of read zone (Of the current state to that of new backup state).
Input TS UDP Failover Enabled	Status	Slow polling, Trap		Show the input transport stream that it needs.
Missing FEC Stream(s)	Text/Status	Trap		Raise when one or both FEC streams are missing for the incoming transport stream.

Alarms (Continued)

Alarm name	Type	Polling or trap?	MIB point	Description
No FEC License Available (Decoding)	Status	Trap		Generated if no license is available at the arrival of an incoming transport stream when the Default Input FEC Settings Mode is set to: 1D FEC or 2D FEC
PAT Error	Status	Trap		Raise when the PAT of the corresponding transport stream is not available within a particular time interval or contains an error.
PID Error	Status	Trap		Raise when the packet with a particular PID and referred to in the PMT is not found.
Sync Byte Error	Status	Trap		Raise when the synchronization byte in a transport stream packet is not detected.
TS Loss	Status	Trap		Raise when one of the following alarms is triggered: Link Loss, UDP Loss, Service Loss, TS Sync Loss, Sync Byte Error, UDP Stream Loss, or PAT Error.
TS Sync Loss	Status	Trap		Raise when the synchronization byte in a sequence of at least two transport stream packets are not detected.
UDP Loss	Status	Trap		Raise when the corresponding port no longer receives UDP packets.
UDP Stream Loss	Status	Trap		Raise when the transport stream, for which services are passed to the output, is no longer detected at the corresponding UDP port.
Unreferenced Pid Error	Status	Trap		Alarm is generated if the DCM receives packets with non-referenced components.
User Selected PCR PID Error	Status	Trap		Alarm generated when the "Time Base Selection" parameter is set to VBR Forced PCR or CBR Forced PCR and the defined service is missing, has no PCR PID, or has a PCR PID that doesn't arrive regularly (within 100 ms).

--- Input > Board > Port > Service alarms ---

Input Service Name	Text	No polling, no trap, internal variable		It is the User name of the Service Settings table. the user name will be used by the user interface to identify the service.
PMT Error	Status	Trap		Raise when the PMT for the service is not available within a particular time interval or contains errors.
Service Loss	Status	Trap		Raise when one of the following alarms is triggered: UDP Loss, UDP Stream Loss, or Missing in PAT, PMT Error, Scrambled Service, Not a Descrambled PID, Descramble a clear PID, PID Error/PID Bitrate Error.

Alarms (Continued)

Alarm name	Type	Polling or trap?	MIB point	Description
------------	------	------------------	-----------	-------------

--- Output > Board > Port alarms ---

DTF Bandwidth Exceeded	Status	Trap		Raise when the sum of the bandwidth of the transport streams encapsulated into a DTF transport stream exceeds the total bitrate for the DTF transport stream.
No FEC License Available (Encoding)	Status	Trap		Raise when not enough licenses are available after a reboot if the Default Input FEC Settings Mode is set to 1D FEC or 2D FEC.
Port Bandwidth Exceeded	Status	Trap		Raise when all outgoing transport streams on a particular GbE port has exceeded the maximum bandwidth for the corresponding port.
Stuffing Threshold Exceeded	Status	Trap		Alarm generated when the threshold is exceeded for the number of out of range packets after hitless merger of the incoming packets on a GbE port.

--- Output > Board > Port > IP address alarms ---

Bandwidth Exceeded	Status	Trap		The sum of the services and components within a transport stream has exceeded the bitrate that is assigned to the transport stream.
--------------------	--------	------	--	---

--- Output > Board > Service alarms ---

Insertion Channel Active	Status	Trap		Generated when a splice event is started.
PMT section exceeds 1K	Status	Trap		This alarm occurs if the PMT section exceeds the limit to 1 K Byte.
SD/HD Mismatch	Status	Trap		Generated when a HD service of which the SD/HD parameter is set to SD then added to a rate control group or when the incoming video component is HD but SD is set for the transcoded video component.
Service in Backup (Service Loss)	Status	Trap		Alarm generated when a service is in backup state triggered by a Service Loss alarm.
Service in Backup (TS Loss)	Status	Trap		Alarm is generated when a service is in backup state triggered by a TS Loss alarm.
Service loss at output	Status	Trap		Alarm generated if the Service Loss alarm is active of the corresponding incoming service.

Alarms (Continued)

Alarm name	Type	Polling or trap?	MIB point	Description
Service Name	Status	No polling, no trap, internal variable		It is the User name of the Service Settings table. The user name will be used by the user interface to identify the service.
Transrating problem	Status	Trap		Alarm generated when the clip used to create still picture services contains errors or when the incoming service is scrambled or when the DCM is not able to control the bitrate of the service due to poor quality of the incoming service.

Configurable parameters

Parameter	Description
<code>pollInterval</code>	Fast poller interval in seconds. Overwrite the default interval of 20 seconds.
<code>retries</code>	If an SNMP request timeout, this defines the number of retries to be performed. Default is 1.
<code>timeout</code>	Delay in seconds before declaring a timeout in the current SNMP request.
<code>uniqueID</code>	An extra identifier to be assigned to the plugin to differentiate its alarms from the other plugin of the same type. ¹
<code>readCommunity</code>	SNMP read community string. Use for SNMP polling.
<code>writeCommunity</code>	SNMP write community string. Use to send SNMP-set commands..
<code>udpLowPollInterval</code>	Fast poller interval in seconds on the UDP signal.
<code>udpHighPollInterval</code>	Slow poller interval in seconds on the UDP signal.

1. The unique ID should be part of the URI.

MIBs used

MIB	MIB file name
RFC 1213 MIB	RFC1213-MIB.mib
SA Europe DCM MIB	SAEUROPE-DCM-MIB.mib
SA Europe Administration MIB	SAEUROPE-ADMINISTRATION-MIB.mib

PowerVu Network Centre

The PowerVu Network Centre (PNC) control system provides a complete digital video compression solution for a wide range of implementations. The PNC application offers a comprehensive solution for network management, decoder management, security, and revenue protection. It is designed to meet the analog and digital content distribution needs of programmers, broadcasters and other network operators; users who need to control multiple encoders and multiplexers in an automatically redundant system transmitting video, audio and data securely to large decoder (receiver) populations will benefit from the PNC's robust and comprehensive feature set.

See on page 21 for device support details:

Alarms

Alarm name	Further details
numberOfSignals	The number of signals configured in the PNC. The current PNC supports up to 4 signals. The maximum number of signals may change in future versions of the PNC.
pncAppStartTime	PNC application start time: <year>-<month>-<day>@<hour>:<minute>:<second> where <year> := 4 decimal digit year <month> := 2 decimal digit month 1..12 <day> := 2 decimal digit day of month 1..31 <hour> := 2 decimal digit hour 0..23 <minute> := 2 decimal digit minute 0..59 <second> := 2 decimal digit second 0..59
pncAppStatus	PNC application status: <ul style="list-style-type: none"> • 0: Running OK • 1: Not running • 2: Starting up • 3: Shutting down • 4: Not installed
pncAppVers	PNC application version: <major version>.<minor version><patch level>{-<option list>} where <major version> := decimal major version number <minor version> := 2 digit decimal minor version number <patch level> := [a..z] <option list> := <option name>... <option name> := text string name of the option (e.g. 4.00g- Bitmizer,Conditional_Access,Cue_Trigger,Disaster_Recovery,Dpi,MetroMux)
pncPlatformStatus	Result of command: prtdiag found in /usr/platform/sun4u/sbin <ul style="list-style-type: none"> • 0: no failures detected • 1: failures detected
pncPlatformSystemDate	Result of command: /usr/bin/date
pncPlatformVers	Result of command: /usr/bin/uname -a

Alarms (Continued)

Alarm name	Further details
signalActiveSecondaryDevices	<p>A list of secondary devices that are active, and which primary devices they are recovering.</p> <p><recovery report> := <device summary><NL><device list></p> <p>where</p> <p><device summary> := <# Active>' secondaries active'</p> <p><# Active> := number of active secondaries</p> <p><device list> := <device recovery>...</p> <p><device recovery> := <secondary>' active for: '<primary></p> <p><secondary> := <device name></p> <p><primary> := <device name></p> <p>Other symbols are defined as for signalMajorAlarmDevices.</p>
signalHighlightAlarmDevices	<p>A list of devices in the signal that are reporting highlighted alarms. Up to 9 alarms may be highlighted. The list of alarms that cause an alarm to be highlighted is configurable on the server by customer service.</p> <p><report> := <device summary><NL><device list></p> <p>where</p> <p><device summary> := <# Alarms>' devices reporting highlighted alarms'</p> <p><# Alarms> := number of devices with highlighted alarms</p> <p><device> := <name>'<alarm list><NL></p> <p><alarm list> := <alarm number>...</p> <p>Other symbols are defined as for signalMajorAlarmDevices.</p>
signalMajorAlarmDevices	<p>A list of devices in the signal that are reporting major alarms.</p> <p><report> := <device summary><NL><device list></p> <p>where</p> <p><device summary> := <# Alarms>' devices reporting major alarms'</p> <p><# Alarms> := Number of devices with a major alarm</p> <p><NL> := newline</p> <p><device list> := <device>...</p> <p><device> := <device name><state><NL></p> <p><device name> := <type><signal #><role><unit #></p> <p><type> := 'MUX' 'MOD' 'AVS' 'ENC' <3 alpha chars></p> <p><signal #> := integer signal number</p> <p><role> := 'P' 'S'</p> <p><unit #> := unit # of the device</p> <p><state> := 'Fail' 'Maint'</p>
signalName	The signal name as defined in the Signal Parameters view

Alarms (Continued)

Alarm name	Further details
signalStatusTable	The signal status table is indexed using the signal number starting from 1. If an index greater than the number of signals is used, the standard SNMP end-of-table response is returned.
signalSummary	A summary status for a signal indicating whether any services are being affected. <ul style="list-style-type: none"> • 0: Offline All devices are offline. No online devices found. • 1: Active Service not affected with primary devices providing service. • 2: Warn Services not affected but a secondary device has been switched in to recover a service. • 3: Fail At least 1 service has been disrupted.

Communications & Power Industries

Ordering information

Hardware	New in iControl version	GSM plug-in name	Order number
TL22CI TWT Compact High Power Amplifier	6.02	SNMP – CPI Amplifier TL22CI	IC-SNMP-241

TL22CI TWT Compact High Power Amplifier

TL22CI-series TWT SuperLinear® high powered amplifiers for satellite communications provide 2250 watts of peak power (1000 watts operating) in a 9RU rack footprint. The TL22CI-series amplifiers can be used, for example, in transportable and fixed-earth station applications.

Comtech EF Data Corp.

Ordering information

Hardware	New in iControl version	GSM plug-in name	Order number
DM240XR High-Speed Digital Modulator	6.02	SNMP – Radyne DM240	IC-SNMP-244

DM240XR High-Speed Digital Modulator



Comtech's DM240XR family of high-speed modulators support both DVB-S and DVB-S2 specifications. The DM240XR can easily be upgraded in the field. The DM240XR unit provides a comprehensive set of advanced S2 features, and extends its dominance in broadcast applications through increased data rate capability and the addition of 16APSK and 32APSK support. Proven performance operating near Shannon's limit offers results with 30% better bandwidth efficiencies and carrier to noise figures below the noise floor.

See the following for device support details:

- on page 24
- on page 26
- on page 28

Health monitoring and text alarms

Alarm name	Type	MIB point	Polling or trap?	Further details
------------	------	-----------	------------------	-----------------

--- Health monitoring alarms ---

Device Communication	Status/health	<code>sysUpTime</code> (RFC1213)	Poller	Device communication alarm set by receiving a successful/failed event in the poller
Device Restart	Status/health	<code>sysUpTime</code> (RFC1213)	Poller	Raise a minor condition based on the value of <code>sysUpTime</code> read is smaller by at least 60 seconds compared to last reading. The value increase by 100 every second.
System uptime	Text/health	<code>sysUpTime</code> (RFC1213)	Poller	System up time alarm, this is a default health monitoring alarm when you use the <code>generic.js</code> to create a new custom driver

--- Text alarms ---

(+) 5V Monitor	Text/health	<code>radPlus5Volts</code>	Fast poller	+5V monitor with implied decimal point. For example, a value of 51 represents +5.1 Volts.
(+) 12V Monitor	Text/health	<code>radPlus12Volts</code>	Fast poller	+12V monitor with implied decimal point. For example, a value of 119 represents +11.9 Volts.
(-) 12V Monitor	Text/health	<code>radMinus12Volts</code>	Fast poller	-12V monitor with implied decimal point. For example, a value of -122 represents -12.2 Volts.
Active input of the RF Port	Text/health	<code>radRfSwitchActiveSide</code>	Fast poller	Indicates the active input of the RF switch
Active PIIC Slot	Text/health	<code>radActivePiicSlot</code>	Fast poller	Indicates the active PIIC slot

Health monitoring and text alarms (*Continued*)

Alarm name	Type	MIB point	Polling or trap?	Further details
Connected Rf Switch Side	Text/health	radRfSwitchConnectorSide	Fast poller	Indicates the side of the RF switch to which the modulator is connected.
Current Rate Precedence	Text/health	radLastRateStatus	Fast poller	Shows the current rate precedence.
Ethernet Card Backup Data Activity	Status and Text / health	radTerrEthActBackup	Fast poller	Shows the backup data activity of the Gig Ethernet card.
Ethernet Card Backup Data Activity (C)	Text/health	radTerrEthActBackupCol	Fast poller	Shows the backup data activity of the Gig Ethernet card.
Ethernet Card Backup Data Activity (R)	Text/health	radTerrEthActBackupRow	Fast poller	Shows the backup data activity of the Gig Ethernet card.
Ethernet Card Corrected Packet Count	Text/health	radTerrEthCorrPkts	Fast poller	Corrected packet count for the Gig Ethernet card.
Ethernet Card Data Activity	Text/health	radTerrEthActPrime	Fast poller	Shows the data activity of the Gig Ethernet card.
Ethernet Card Data Activity (C)	Text/health	radTerrEthActPrimeCol	Fast poller	Shows the data activity of the Gig Ethernet card (column).
Ethernet Card Data Activity (R)	Text/health	radTerrEthActPrimeRow	Fast poller	Shows the data activity of the Gig Ethernet card (row).
Ethernet Card Fill of Jitter (%)	Text/health	radTerrEthJitterFill	Fast poller	Percent fill of jitter buffer for the Gig Ethernet card.
Ethernet Card Link Status	Text/health	radTerrEthPortStatus	Fast poller	Shows the link status of the active Gig Ethernet card.
Ethernet Card Null Packet Count	Text/health	radTerrEthNullPkts	Fast poller	Null packet count for the Gig Ethernet card.
Ethernet Card Reordered Packet Count	Text/health	radTerrEthReorPkts	Fast poller	Reordered packet count for the Gig Ethernet card.
Fault Status	Text/health	radRfSwitchDistantSideFault	Fast poller	Indicates the fault status of the modulator at the distant side of the RF switch.
Firmware Part and Revision Number	Text/health	radFirmwarePartRev	Fast poller	Provides the system firmware part and revision number.
M&C Revision Number	Text/health	radRevisionNumber	Fast poller	M&C Revision number.
Temperature	Text/health	radTemperature	Fast poller	Temperature monitor with implied decimal point. For example, a value of 490 represents 49.0 C

Bitfield alarms

Alarm name	Type	MIB point	Polling or trap?	Further details
------------	------	-----------	------------------	-----------------

--- Common alarms mask ---

Common Alarms Mask	Text	radCommonAlarmMask	Fast poller	Common Alarm mask: A bit field. 0 = MASKED, 1 = UNMASKED
(-) 12V alarm	status		Fast poller	Bit 0
(+) 12V alarm	status		Fast poller	Bit 1
(+) 5V alarm	status		Fast poller	Bit 2

--- Common alarms status ---

Common Alarms Status	Text	radCommonAlarmStatus	Fast poller	Common Alarm status: A bit field. 0 = PASS, 1 = FAIL
(-) 12V alarm	status		Fast poller	Bit 0
(+) 12V alarm	status		Fast poller	Bit 1
(+) 5V alarm	status		Fast poller	Bit 2

--- Major alarms mask ---

Major Alarms Mask	Text	radMajorAlarmMask	Fast poller	Major Alarm mask: A bit field. 0 = MASKED, 1 = UNMASKED
Over Sample Clock PLL Lock	status		Fast poller	Bit 1
FPGA Configuration Error	status		Fast poller	Bit 2
Synthesis ClockPLL Lock	status		Fast poller	Bit 3
External Reference PLL Lock	status		Fast poller	Bit 4
Composite PLL Lock	status		Fast poller	Bit 5
Symbol PLL Lock	status		Fast poller	Bit 6
Invalid Terrestrial Interface	status		Fast poller	Bit 7

--- Major alarms status ---

Major Alarms Status	Text	radMajorAlarmStatus	Fast poller	Major Alarm status: A bit field. 0 = PASS, 1 = FAIL
Over Sample Clock PLL Lock	status		Fast poller	Bit 1
FPGA Configuration Error	status		Fast poller	Bit 2
Synthesis ClockPLL Lock	status		Fast poller	Bit 3

Bitfield alarms (*Continued*)

Alarm name	Type	MIB point	Polling or trap?	Further details
External Reference PLL Lock	status		Fast poller	Bit 4
Composite PLL Lock	status		Fast poller	Bit 5
Symbol PLL Lock	status		Fast poller	Bit 6
Invalid Terrestrial Interface	status		Fast poller	Bit 7

--- Minor alarms mask ---

Minor Alarms Mask	Text	<code>radMinorAlarmMask</code>	Fast poller	Minor Alarm mask: A bit field. 0 = MASKED, 1 = UNMASKED
Terrestrial Ethernet Data Activity Detect	status		Fast poller	Bit 0
Terrestrial Clock Activity Detect	status		Fast poller	Bit 1
Tx Data Activity Detect	status		Fast poller	Bit 2
FIFO Overflow/Underflow Error	status		Fast poller	Bit 3
Output Level	status		Fast poller	Bit 4
Loss of Frame Synchronization	status		Fast poller	Bit 5
Terrestrial Ethernet Jitter Buffer Underflow	status		Fast poller	Bit 6
Terrestrial Ethernet Jitter Buffer Overflow	status		Fast poller	Bit 7

--- Minor alarms status ---

Minor Alarms Status	Text	<code>radMinorAlarmStatus</code>	Fast poller	Common Alarm status: A bit field. 0 = PASS, 1 = FAIL
Terrestrial Ethernet Data Activity Detect	status		Fast poller	Bit 0
Terrestrial Clock Activity Detect	status		Fast poller	Bit 1
Tx Data Activity Detect	status		Fast poller	Bit 2
FIFO Overflow/Underflow Error	status		Fast poller	Bit 3
Output Level	status		Fast poller	Bit 4

Bitfield alarms (*Continued*)

Alarm name	Type	MIB point	Polling or trap?	Further details
Loss of Frame Synchronization	status		Fast poller	Bit 5
Terrestrial Ethernet Jitter Buffer Underflow	status		Fast poller	Bit 6
Terrestrial Ethernet Jitter Buffer Overflow	status		Fast poller	Bit 7

Configurable parameters

Parameter	Description
<code>pollInterval</code>	Fast poller interval in seconds. Overwrite the default interval of 20 seconds.
<code>retries</code>	If an SNMP request timeout, this defines the number of retries to be performed. Default is 1.
<code>timeout</code>	Delay in seconds before declaring a timeout in the current SNMP request.
<code>uniqueID</code>	An extra identifier to be assigned to the plugin to differentiate its alarms from the other plugin of the same type. The uniqueID should be part of uri.
<code>readCommunity</code>	SNMP read community string. Use for SNMP polling.

Crystal Solutions

Ordering information

Hardware	New in iControl version	GSM plug-in name	Order number
CrystalVision 2000		SNMP – CrystalVision 2000	IC-SNMP-021

CrystalVision 2000

Network Management and Control System for INSP integrated devices; provides a centralized monitoring capability for uplink and downlink equipment (satellite monitoring).

Dantel

Ordering information

Hardware	New in iControl version	GSM plug-in name	Order number
PointMaster	5.00	SNMP – Dantel PointMaster	IC-SNMP-218
Webmon Edge/Matrix	5.00	SNMP – Dantel Webmon Edge / Matrix	IC-SNMP-219

PointMaster

Webmon Edge/Matrix

Davicom

Ordering information

Hardware	New in iControl version	GSM plug-in name	Order number
Davicom MAC PLUS		SNMP – Davicom MAC Plus	IC-SNMP-001

Davicom MAC PLUS

Standalone monitoring and control unit able to interface with virtually any type of remote site equipment and sensors.

EGT

Please see [Arris on page 3](#).

Dothill

Ordering information

Hardware	New in iControl version	GSM plug-in name	Order number
SAN Controller	5.00	SNMP – Dothill SAN Controller	IC-SNMP-198

DVB Control

Ordering information

Hardware	New in iControl version	GSM plug-in name	Order number
DVBMonitor			IC-SNMP-222

EMC

Ordering information

Hardware	New in iControl version	GSM plug-in name	Order number
NAS Network Attached Storage (formerly Isilon NAS Network Attached Storage)	6.04	SNMP – Isilon NAS	IC-SNMP-142

NAS Network Attached Storage (formerly *Isilon NAS Network Attached Storage*)



EMC Isilon scale-out NAS storage consolidates and manages enterprise data and applications. The EMC Isilon X-Series is a flexible scale-out platform that strikes the right balance between large capacity and high-performance storage. With SSD technology for file system metadata and file-based storage workflows, the EMC Isilon X-Series significantly accelerates namespace-intensive operations.

- on page 30
- on page 37

Alarms provided by the driver

Alarm name	Type	Poll/Trap	Alarm URI	MIB node name	OID
--- Cluster: CPU ---					
CPU Idle Pct	Text	Poll	Cluster/CPU/clusterCPUIdlePct	clusterCPUIdlePct	.1.3.6.1.4.1.12124.1.2.3.5
CPU Interrupt	Text	Poll	Cluster/CPU/clusterCPUInterrupt	clusterCPUInterrupt	.1.3.6.1.4.1.12124.1.2.3.4
CPU Nice	Text	Poll	Cluster/CPU/clusterCPUNice	clusterCPUNice	.1.3.6.1.4.1.12124.1.2.3.2
CPU System	Text	Poll	Cluster/CPU/clusterCPUSystem	clusterCPUSystem	.1.3.6.1.4.1.12124.1.2.3.3

Alarms provided by the driver (Continued)

Alarm name	Type	Poll/ Trap	Alarm URI	MIB node name	OID
CPU User	Text	Poll	Cluster/CPU/clusterCPUUser	clusterCPUUser	.1.3.6.1.4.1.12124.1.2.3.1

--- Cluster: File system ---

Access Time Enabled	Text	Poll	Cluster/File_System/accessTimeEnabled	accessTimeEnabled	.1.3.6.1.4.1.12124.1.3.10
Access Time Grace	Text	Poll	Cluster/File_System/accessTimeGracePeriod	accessTimeGracePeriod	.1.3.6.1.4.1.12124.1.3.11

--- Cluster: License: 1 ---

License Expiration Date	Text	Poll	Cluster/License/1/licenseExpirationDate	licenseTable	.1.3.6.1.4.1.12124.1.5.1.1.5
License Module Name	Text	Poll	Cluster/License/1/licenseModuleName	licenseTable	.1.3.6.1.4.1.12124.1.5.1.1.2
License Status Text	Text	Poll	Cluster/License/1/licenseStatusText	licenseTable	.1.3.6.1.4.1.12124.1.5.1.1.3

--- Cluster: License: 2 ---

License Expiration Date	Text	Poll	Cluster/License/2/licenseExpirationDate	licenseTable	.1.3.6.1.4.1.12124.1.5.1.1.5
License Module Name	Text	Poll	Cluster/License/2/licenseModuleName	licenseTable	.1.3.6.1.4.1.12124.1.5.1.1.2
License Status Text	Text	Poll	Cluster/License/2/licenseStatusText	licenseTable	.1.3.6.1.4.1.12124.1.5.1.1.3

--- Cluster: Snapshot ---

Reserved Pct	Text	Poll	Cluster/Snapshot/snapshotReservedPct	snapshotReservedPct	.1.3.6.1.4.1.12124.1.13.1.3
Root Access CIFS	Text	Poll	Cluster/Snapshot/snapshotRootAccessCIFS	snapshotRootAccessCIFS	.1.3.6.1.4.1.12124.1.13.1.8
Root Access Local	Text	Poll	Cluster/Snapshot/snapshotRootAccessLocal	snapshotRootAccessLocal	.1.3.6.1.4.1.12124.1.13.1.11
Root Access NFS	Text	Poll	Cluster/Snapshot/snapshotRootAccessNFS	snapshotRootAccessNFS	.1.3.6.1.4.1.12124.1.13.1.5
Root Visibility CIFS	Text	Poll	Cluster/Snapshot/snapshotRootVisibilityCIFS	snapshotRootVisibilityCIFS	.1.3.6.1.4.1.12124.1.13.1.7
Root Visibility local	Text	Poll	Cluster/Snapshot/snapshotRootVisibilityLocal	snapshotRootVisibilityLocal	.1.3.6.1.4.1.12124.1.13.1.10

Alarms provided by the driver (Continued)

Alarm name	Type	Poll/ Trap	Alarm URI	MIB node name	OID
Root Visibility NFS	Text	Poll	Cluster/Snapshot/snapshotRootVisibilityNFS	snapshotRootVisibilityNFS	.1.3.6.1.4.1.12124.1.13.1.4
Schedule Create Enabled	Text	Poll	Cluster/Snapshot/snapshotScheduledCreateEnabled	snapshotScheduledCreateEnabled	.1.3.6.1.4.1.12124.1.13.1.1
Schedule Delete Enabled	Text	Poll	Cluster/Snapshot/snapshotScheduledDeleteEnabled	snapshotScheduledDeleteEnabled	.1.3.6.1.4.1.12124.1.13.1.2
Subdir Access CIFS	Text	Poll	Cluster/Snapshot/snapshotSubdirAccessCIFS	snapshotSubdirAccessCIFS	.1.3.6.1.4.1.12124.1.13.1.9
Subdir Access Local	Text	Poll	Cluster/Snapshot/snapshotSubdirAccessLocal	snapshotSubdirAccessLocal	.1.3.6.1.4.1.12124.1.13.1.12
Subdir Access NFS	Text	Poll	Cluster/Snapshot/snapshotSubdirAccessNFS	snapshotSubdirAccessNFS	.1.3.6.1.4.1.12124.1.13.1.6

--- Health monitoring ---

Device Communication	Status	Poll	deviceCommAlarm		
Device Restart	Status	Poll	deviceRestartAlarm		
System Uptime	Text	Poll	sysUpTime	sysUpTime	.1.3.6.1.2.1.1.3

--- Node: Chassis: 1 ---

Chassis Config Number	Text	Poll	Node/Chassis/1/chassisConfigNumber	chassisTable	.1.3.6.1.4.1.12124.2.51.1.2
Chassis Led	Status	Poll	Node/Chassis/1/chassisUnitIDLEDO	chassisTable	.1.3.6.1.4.1.12124.2.51.1.5
Chassis Number	Text	Poll	Node/Chassis/1/chassisNumber	chassisTable	.1.3.6.1.4.1.12124.2.51.1.1
Model	Text	Poll	Node/Chassis/1/chassisModel	chassisTable	.1.3.6.1.4.1.12124.2.51.1.4
Serial Number	Text	Poll	Node/Chassis/1/chassisSerialNumber	chassisTable	.1.3.6.1.4.1.12124.2.51.1.3

--- Node: Chassis: 2 ---

Chassis Config Number	Text	Poll	Node/Chassis/2/chassisConfigNumber	chassisTable	.1.3.6.1.4.1.12124.2.51.1.2
Chassis Led	Status	Poll	Node/Chassis/2/chassisUnitIDLEDO	chassisTable	.1.3.6.1.4.1.12124.2.51.1.5

Alarms provided by the driver (Continued)

Alarm name	Type	Poll/ Trap	Alarm URI	MIB node name	OID
Chassis Number	Text	Poll	Node/Chassis/2/chassisNumber	chassisTable	.1.3.6.1.4.1.12124.2.51.1.1
Model	Text	Poll	Node/Chassis/2/chassisModel	chassisTable	.1.3.6.1.4.1.12124.2.51.1.4
Serial Number	Text	Poll	Node/Chassis/2/chassisSerialNumber	chassisTable	.1.3.6.1.4.1.12124.2.51.1.3

--- Node: CPU: 1 ---

CPU Idle	Text	Poll	Node/CPU/1/nodePerCPUIdle	nodeCPUPerfTable	.1.3.6.1.4.1.12124.2.2.3.10.1.5
CPU Interrupt	Text	Poll	Node/CPU/1/nodePerCPUInterrupt	nodeCPUPerfTable	.1.3.6.1.4.1.12124.2.2.3.10.1.4
CPU Nice	Text	Poll	Node/CPU/1/nodePerCPUNice	nodeCPUPerfTable	.1.3.6.1.4.1.12124.2.2.3.10.1.2
CPU System	Text	Poll	Node/CPU/1/nodePerCPUSystem	nodeCPUPerfTable	.1.3.6.1.4.1.12124.2.2.3.10.1.3
CPU User	Text	Poll	Node/CPU/1/nodePerCPUUser	nodeCPUPerfTable	.1.3.6.1.4.1.12124.2.2.3.10.1.1

--- Node: CPU: 2 ---

CPU Idle	Text	Poll	Node/CPU/2/nodePerCPUIdle	nodeCPUPerfTable	.1.3.6.1.4.1.12124.2.2.3.10.1.5
CPU Interrupt	Text	Poll	Node/CPU/2/nodePerCPUInterrupt	nodeCPUPerfTable	.1.3.6.1.4.1.12124.2.2.3.10.1.4
CPU Nice	Text	Poll	Node/CPU/2/nodePerCPUNice	nodeCPUPerfTable	.1.3.6.1.4.1.12124.2.2.3.10.1.2
CPU System	Text	Poll	Node/CPU/2/nodePerCPUSystem	nodeCPUPerfTable	.1.3.6.1.4.1.12124.2.2.3.10.1.3
CPU User	Text	Poll	Node/CPU/2/nodePerCPUUser	nodeCPUPerfTable	.1.3.6.1.4.1.12124.2.2.3.10.1.1

--- Node: CPU ---

Avg CPU Idle	Text	Poll	Node/CPU/nodeCPUIdle	nodeCPUIdle	.1.3.6.1.4.1.12124.2.2.3.10.1.5
Avg CPU Interrupt	Text	Poll	Node/CPU/nodeCPUInterrupt	nodeCPUInterrupt	.1.3.6.1.4.1.12124.2.2.3.10.1.4
Avg CPU Nice	Text	Poll	Node/CPU/nodeCPUNice	nodeCPUNice	.1.3.6.1.4.1.12124.2.2.3.10.1.2
Avg CPU System	Text	Poll	Node/CPU/nodeCPUSystem	nodeCPUSystem	.1.3.6.1.4.1.12124.2.2.3.10.1.3
Avg CPU User	Text	Poll	Node/CPU/nodeCPUUser	nodeCPUUser	.1.3.6.1.4.1.12124.2.2.3.10.1.1

Alarms provided by the driver (Continued)

Alarm name	Type	Poll/ Trap	Alarm URI	MIB node name	OID
--- Node: Disk: 1 ---					
Disk Bay	Text	Poll	Node/Disk/1/diskBay	diskTable	.1.3.6.1.4.1.12124.2.52 .1.1
Disk Chassis Number	Text	Poll	Node/Disk/1/diskChassisNumber	diskTable	.1.3.6.1.4.1.12124.2.52 .1.3
Disk Logical Number	Text	Poll	Node/Disk/1/diskLogicalNumber	diskTable	.1.3.6.1.4.1.12124.2.52 .1.2
Disk Model	Text	Poll	Node/Disk/1/diskModel	diskTable	.1.3.6.1.4.1.12124.2.52 .1.6
Disk Name	Text	Poll	Node/Disk/1/diskDeviceName	diskTable	.1.3.6.1.4.1.12124.2.52 .1.4
Disk Status	Text	Poll	Node/Disk/1/diskStatus	diskTable	.1.3.6.1.4.1.12124.2.52 .1.5
Firmware Version	Text	Poll	Node/Disk/1/diskFirmwareVersion	diskTable	.1.3.6.1.4.1.12124.2.52 .1.8
Serial Number	Text	Poll	Node/Disk/1/diskSerialNumber	diskTable	.1.3.6.1.4.1.12124.2.52 .1.7
--- Node: Disk: 2 ---					
Disk Bay	Text	Poll	Node/Disk/2/diskBay	diskTable	.1.3.6.1.4.1.12124.2.52 .1.1
Disk Chassis Number	Text	Poll	Node/Disk/2/diskChassisNumber	diskTable	.1.3.6.1.4.1.12124.2.52 .1.3
Disk Logical Number	Text	Poll	Node/Disk/2/diskLogicalNumber	diskTable	.1.3.6.1.4.1.12124.2.52 .1.2
Disk Model	Text	Poll	Node/Disk/2/diskModel	diskTable	.1.3.6.1.4.1.12124.2.52 .1.6
Disk Name	Text	Poll	Node/Disk/2/diskDeviceName	diskTable	.1.3.6.1.4.1.12124.2.52 .1.4
Disk Status	Text	Poll	Node/Disk/2/diskStatus	diskTable	.1.3.6.1.4.1.12124.2.52 .1.5
Firmware Version	Text	Poll	Node/Disk/2/diskFirmwareVersion	diskTable	.1.3.6.1.4.1.12124.2.52 .1.8
Serial Number	Text	Poll	Node/Disk/2/diskSerialNumber	diskTable	.1.3.6.1.4.1.12124.2.52 .1.7
--- Node: Disk Perf: 1 ---					
Disk Bay	Text	Poll	Node/Disk_Perf/1/diskPerfBay	diskPerfTable	.1.3.6.1.4.1.12124.2.2. 52.1.1
Disk Input Rate	Text	Poll	Node/Disk_Perf/1/diskPerfInBitsP erSecond	diskPerfTable	.1.3.6.1.4.1.12124.2.2. 52.1.4

Alarms provided by the driver (Continued)

Alarm name	Type	Poll/ Trap	Alarm URI	MIB node name	OID
Disk Name	Text	Poll	Node/Disk_Perf/1/diskPerfDeviceName	diskPerfTable	.1.3.6.1.4.1.12124.2.2.52.1.2
Disk Ops per sec	Text	Poll	Node/Disk_Perf/1/diskPerfOpsPerSecond	diskPerfTable	.1.3.6.1.4.1.12124.2.2.52.1.3
Disk Output Rate	Text	Poll	Node/Disk_Perf/1/diskPerfOutBytesPerSecond	diskPerfTable	.1.3.6.1.4.1.12124.2.2.52.1.5

--- Node: Disk Perf: 2 ---

Disk Bay	Text	Poll	Node/Disk_Perf/2/diskPerfBay	diskPerfTable	.1.3.6.1.4.1.12124.2.2.52.1.1
Disk Input Rate	Text	Poll	Node/Disk_Perf/2/diskPerfInBitsPerSecond	diskPerfTable	.1.3.6.1.4.1.12124.2.2.52.1.4
Disk Name	Text	Poll	Node/Disk_Perf/2/diskPerfDeviceName	diskPerfTable	.1.3.6.1.4.1.12124.2.2.52.1.2
Disk Ops per sec	Text	Poll	Node/Disk_Perf/2/diskPerfOpsPerSecond	diskPerfTable	.1.3.6.1.4.1.12124.2.2.52.1.3
Disk Output Rate	Text	Poll	Node/Disk_Perf/2/diskPerfOutBytesPerSecond	diskPerfTable	.1.3.6.1.4.1.12124.2.2.52.1.5

--- Node: Fans: 1 ---

Description	Text	Poll	Node/Fans/1/fanDescription	fanTable	.1.3.6.1.4.1.12124.2.53.1.3
Fan Number	Text	Poll	Node/Fans/1/fanNumber	fanTable	.1.3.6.1.4.1.12124.2.53.1.1
Name	Text	Poll	Node/Fans/1/fanName	fanTable	.1.3.6.1.4.1.12124.2.53.1.2
Speed	Text	Poll	Node/Fans/1/fanSpeed	fanTable	.1.3.6.1.4.1.12124.2.53.1.4

--- Node: Fans: 2 ---

Description	Text	Poll	Node/Fans/2/fanDescription	fanTable	.1.3.6.1.4.1.12124.2.53.1.3
Fan Number	Text	Poll	Node/Fans/2/fanNumber	fanTable	.1.3.6.1.4.1.12124.2.53.1.1
Name	Text	Poll	Node/Fans/2/fanName	fanTable	.1.3.6.1.4.1.12124.2.53.1.2
Speed	Text	Poll	Node/Fans/2/fanSpeed	fanTable	.1.3.6.1.4.1.12124.2.53.1.4

--- Node: Status ---

Node Health	Status	Poll	Node/Status/nodeHealth	nodeHealth	.1.3.6.1.4.1.12124.2.1.2
Node Name	Text	Poll	Node/Status/nodeName	nodeName	.1.3.6.1.4.1.12124.2.1.1

Alarms provided by the driver (Continued)

Alarm name	Type	Poll/Trap	Alarm URI	MIB node name	OID
Node Type	Text	Poll	Node/Status/nodeType	nodeType	.1.3.6.1.4.1.12124.2.1.3
Read Only	Text	Poll	Node/Status/readOnly	readOnly	.1.3.6.1.4.1.12124.2.1.4

--- Node: Temperature: 1 ---

Description	Text	Poll	Node/Temperature/1/tempSensorDescription	tempSensorTable	.1.3.6.1.4.1.12124.2.54.1.3
Name	Text	Poll	Node/Temperature/1/tempSensorName	tempSensorTable	.1.3.6.1.4.1.12124.2.54.1.2
Sensor	Text	Poll	Node/Temperature/1/tempSensorNumber	tempSensorTable	.1.3.6.1.4.1.12124.2.54.1.1
Value	Text	Poll	Node/Temperature/1/tempSensorValue	tempSensorTable	.1.3.6.1.4.1.12124.2.54.1.4

--- Node: Temperature: 2 ---

Description	Text	Poll	Node/Temperature/2/tempSensorDescription	tempSensorTable	.1.3.6.1.4.1.12124.2.54.1.3
Name	Text	Poll	Node/Temperature/2/tempSensorName	tempSensorTable	.1.3.6.1.4.1.12124.2.54.1.2
Sensor	Text	Poll	Node/Temperature/2/tempSensorNumber	tempSensorTable	.1.3.6.1.4.1.12124.2.54.1.1
Value	Text	Poll	Node/Temperature/2/tempSensorValue	tempSensorTable	.1.3.6.1.4.1.12124.2.54.1.4

--- Node: Voltage: 1 ---

Description	Text	Poll	Node/Voltage/1/powerSensorDescription	powerSensorTable	.1.3.6.1.4.1.12124.2.55.1.3
Name	Text	Poll	Node/Voltage/1/powerSensorName	powerSensorTable	.1.3.6.1.4.1.12124.2.55.1.2
Sensor Number	Text	Poll	Node/Voltage/1/powerSensorNumber	powerSensorTable	.1.3.6.1.4.1.12124.2.55.1.1
Value	Text	Poll	Node/Voltage/1/powerSensorValue	powerSensorTable	.1.3.6.1.4.1.12124.2.55.1.4

--- Node: Voltage: 2 ---

Description	Text	Poll	Node/Voltage/2/powerSensorDescription	powerSensorTable	.1.3.6.1.4.1.12124.2.55.1.3
Name	Text	Poll	Node/Voltage/2/powerSensorName	powerSensorTable	.1.3.6.1.4.1.12124.2.55.1.2
Sensor Number	Text	Poll	Node/Voltage/2/powerSensorNumber	powerSensorTable	.1.3.6.1.4.1.12124.2.55.1.1
Value	Text	Poll	Node/Voltage/2/powerSensorValue	powerSensorTable	.1.3.6.1.4.1.12124.2.55.1.4

Certain parameters can be passed to the driver, as follows:

Parameters

Name	Description/Notes	Default value	Configurable in GUI
pollInterval	Poller interval in seconds. Overwrite the default interval.	5	NO
retries	If an SNMP request times out, this defines the number of retries to be performed.	2	NO
timeout	Delay in seconds before declaring a timeout in the current SNMP request.	5	NO
uniqueID	An extra identifier to be assigned to the plugin to differentiate its alarms from the other plugin of the same type. The uniqueID should be part of uri.		NO
readCommunity	SNMP read community string, used for SNMP polling.	Public	NO
writeCommunity	SNMP write community string, used to send SNMP-set commands.		NO

Ensemble Designs

Ordering information

Hardware	New in iControl version	GSM plug-in name	Order number
Avenue Modular Interfaces		SNMP – Ensemble Design Avenue	IC-SNMP-087

Avenue Modular Interfaces

Modular video and audio interfaces; expandable, modular tray based signal integration system. Provides signal processing, infrastructure and control.

Envivio

Ordering information

Hardware	New in iControl version	GSM plug-in name	Order number
4Caster C4 Encoder		SNMP – Envivio 4Caster C4	IC-SNMP-133
4Manager	5.00	SNMP – Envivio 4Manager	IC-SNMP-217

4Caster C4 Encoder

Envivio 4Caster C4 is an encoding/transcoding appliance.

Ericsson

Ordering information

Hardware	New in iControl version	GSM plug-in name	Order number
nCompass Control		SNMP – Ericsson/Tandberg nCompass	IC-SNMP-081
RX1290 Multi-Format SD/HD IRD		SNMP – Ericsson/Tandberg RX1290	IC-SNMP-121
RX8200-Series Advanced Modular Receiver	4.30	SNMP – Ericsson/Tandberg RX8200	IC-SNMP-151
TT1260 Integrated Receiver Decoder		SNMP – Ericsson TT1260	IC-SNMP-005
TT4130 Transport Stream Analyzer		SNMP – Ericsson TT4130	IC-SNMP-122
Ericsson iPlex (formerly SkyStream iPlex)		SNMP – Ericsson/Tandberg iPlex	IC-SNMP-172
Ericsson MediaPlex (formerly SkyStream MediaPlex)		SNMP – Ericsson/Tandberg MediaPlex	IC-SNMP-173
--- Frames ---			
Ericsson/ETV VPC Frame	6.03	SNMP – ETV frame	IC-SNMP-259
--- Frame modules ---			
ETV Module—CE Host Controller Card	6.03	SNMP – ETV CE Host Controller Card	IC-SNMP-260
ETV Module—CE-x H20 Encoder Card	6.03	SNMP – ETV CE-x H20 Encoder Card	IC-SNMP-261
ETV Module—CE-x H20 Pre-Processor Card	6.03	SNMP – ETV CE-x H20 Preprocessor Card	IC-SNMP-262

nCompass Control

nCompass Control offers service providers a means to manage Ericsson's full range of video headend systems and broadcast products.

RX1290 Multi-Format SD/HD IRD



The RX1290 is a multi-format SD/HD integrated receiver/decoder, capable of decoding all video formats. The RX1290 is compatible with MPEG-2, MPEG-4 AVC, SD, and HD and can decode both 4:2:0 and 4:2:2 video.

RX8200-Series Advanced Modular Receiver

The RX8200 Advanced Modular Receiver decodes video and offers connectivity for a wide range of transmission media.

TT1260 Integrated Receiver Decoder

The TT1260 is a professional grade IRD able to decode MPEG-2 SD 4:2:2 video. The TT1260 has dual SDI output, dual analog BNC outputs, remote control via SNMP or Web page, and CAM menu browsing via Web browser.

TT4130 Transport Stream Analyzer

The TT4130 Transport Stream Analyzer combines advanced error detection and monitoring via a Web interface in a 3RU multi-channel unit for MPEG-2 and MPEG-4 AVC transport streams.

The TT4130 offers a compact multi-channel transport stream analyzer with a wide range of input interface options making it suitable for use in a range of markets: cable, satellite, terrestrial, mobile, distribution and contribution.

Ericsson iPlex (*formerly SkyStream iPlex*)

The iPlex is a high density, multi-functional video processing platform designed for telco, cable and satellite operators delivering IPTV over DSL infrastructure.

Ericsson MediaPlex (*formerly SkyStream MediaPlex*)

The Mediaplex-20 video processing platform is a multi-function, carrier-grade IPTV headend.

ETV Module—CE Host Controller Card

See the following for device support details:

- on page 39

ETV module—CE host controller card alarms

Alarm name	Type	Polling or trap?	Description	URI format	MIB name
+12V A Failed					
+12V B Failed					
Fan Failure					
Internal Hardware Issue					

ETV module—CE host controller card alarms (*Continued*)

Alarm name	Type	Polling or trap?	Description	URI format	MIB name
Option Card Comms Failure in slot					
Option card failed to boot					
Over Temperature					
Over Temperature Warning					
Power On Self Test Failure					
System Clock Not Locked					

ETV Module—CE-x H20 Encoder Card

The Ericsson CE-x Series encoder modules support MPEG-4 AVC Fidelity Range Extensions (FRExt), enabling broadcasters and operators to capture, archive and distribute content in high-quality HDTV.

See the following for device support details:

- on page 40
- on page 41
- on page 41

Alarms

Alarm name	Type	Polling or trap?	MIB point	Code to raise alarm	Description
Licensed					
--- Health Monitoring ---					
Over Temperature					
Over Temperature Warning					
Power On Self Test Failure					
SMPTE334 Closed Captions Input Lock					

Alarms (Continued)

Alarm name	Type	Polling or trap?	MIB point	Code to raise alarm	Description
Video/Audio Module Error					
Video Processor Boot Failure					

--- **Signal** ---

Audio Input Lock					
Audio n silence					
Audio Module Error					
Video Input Lock					

Configurable parameters

Parameter name	Parameter object key	Description	Default value
Alarm Path	<code>alarmPath</code>	Path under which alarms are created in IC Nav	"GrassValley/K2_Summit(<IP>)"
Poll Interval	<code>pollInterval</code>	Period between repeated SNMP polls to the device	30 seconds
Retries	<code>retries</code>	Number of times to retry after a failed SNMP poll	1 retry
Timeout	<code>timeout</code>	Number of seconds to wait for a response before declaring SNMP poll failed	3 seconds
Unique ID	<code>uniqueID</code>	An extra identifier to be assigned to the plugin to differentiate its alarms from the other plugin of the same type. The uniqueID should be part of uri.	
Read Community	<code>readCommunity</code>	SNMP read community string (password)	"public"
Write Community	<code>writeCommunity</code>	SNMP write community string (password)	"public"

MIBs used

MIB	MIB file name
ETV-Configuration-MIB	ETV-CONFIGURATION-MIB.mib
ETV-AlarmTrap-MIB	ETV-ALARMTRAP-MIB.mib

Evertz

Ordering information

Hardware	New in iControl version	GSM plug-in name	Order number
500-Series Frame	4.03	SNMP – Evertz 500	IC-SNMP-128
500FC, 500DA		SNMP – Evertz 500 (FC + DA)	IC-SNMP-129
FC3405 Frame Controllers and Power Converters	6.02	SNMP – Evertz 3000	IC-SNMP-130
3405FR-BNC ★	6.20	SNMP – Evertz 3405	IC-SNMP-248
3000MVP Multiviewer Platform ★	6.20	SNMP – Evertz 3000MVP	IC-SNMP-295
5600 ACO2 Automatic Changeover	4.30	SNMP – Evertz MSC5600 ACO2	IC-SNMP-136
5600MSC Master Sync and Clock Generator	4.30	SNMP – Evertz MSC5600	IC-SNMP-189
7867VIPA-DUO	6.02	SNMP – Evertz 7867VIPA-DUO	IC-SNMP-235
7700-Series Frame		SNMP – Evertz 7700	IC-SNMP-042
7767VIP HSN ★	6.20	SNMP – Evertz VIP7767HSN	IC-SNMP-289
Keyer	5.00	SNMP – Evertz Keyer	IC-SNMP-212
Xenon Routing Switcher		SNMP – Evertz Xenon	IC-SNMP-090

500-Series Frame

The Evertz 500FR Compact Distribution Frame is a 3RU front-loading frame designed to house up to 16 single slot modules.

500FC, 500DA

The 500FC VistaLINK® Frame Controller card enables communication with VistaLINK® 500-series modules via a 10/100BASE-TX Ethernet port. The 500FC handles all SNMP communications between a frame and a network management system, and serves as a gateway to individual cards in the frame.

FC3405 Frame Controllers and Power Converters



Evertz® 3405FR-XLINK frame

The Evertz® 3405FC frame controller is the control interface for the family of rack-mounted Evertz SFP frames that include the 3405FR-BNC, 3405FR-DIN, and 3405FR-XLINK frames.

See the following for device support details:

- on page 43
- on page 45

Health monitoring alarms

Alarm name	Type	MIB point	Polling or trap?	Further details
------------	------	-----------	------------------	-----------------

--- Health monitoring alarms ---

Device Communication	status/health	sysUpTime (RFC1213)	Polling	Device communication alarm set by receiving a successful/failed event in the poller
Device Restart	status/health	sysUpTime (RFC1213)	Polling	Raise a minor condition based on the value of <code>sysUpTime</code> read is smaller by at least 60 seconds compared to last reading. The value increase by 100 every second.
System uptime	status/health	sysUpTime (RFC1213)	Polling	System up time alarm, this is a default health monitoring alarm when you use the <code>generic.js</code> to create a new custom driver

--- Monitor alarms ---

The device has sixteen SFP ports. The information on alarms will be displayed for each valid SFP on the device.

Version	Text		Polling	Version number for the SFP module
---------	------	--	---------	-----------------------------------

Health monitoring alarms (*Continued*)

Alarm name	Type	MIB point	Polling or trap?	Further details
Upgrade Support	Status		Polling	Indicates whether the SFP firmware can be upgraded using the second stage bootloader
Serial number	Text		Polling	Serial number for SFP module
Id	Text		Polling	Describe the specific type of SFP
Class	Text	FC3405-MIB	Polling	Describe the base class of SFPs

--- TX alarms ---

TX data are on two cannons Laser A and Laser B, the information displayed is done for both tables of index : laserA (1) , laserB (2)

txBiasCurrent	Text	FC3405-MIB	Polling and trap	Displays bias current on laser in units of 0.01 mA
txLaserEn	Text		Polling and trap	Tells about SFPTX laser status
txLaserStatus	Text		Polling and trap	Tells about wavelength supported by SFPTX's lasers
txReclock	Text		polling and trap	displays the reclocker status
txWavelength	Text		polling and trap	tells about SFP TX laser status

--- RX alarms ---

RX data are on two cannons Laser A and Laser B, the information displayed is done for both. table of indexes : laserA (1) , laserB (2)

rxLaserPowr	Text	FC3405-MIB	polling and trap	tells about SFP RX received power status
rxReclock	Text		polling and trap	displays the reclocker status

--- Notify alarms ---

These statuses are displayed for each index in this table.

Table of indexes : txCarrier1 (1) , txCarrier2 (2) , rxLoss1 (3) , rxLoss2 (4) , rxOptPwrHigh1 (5) , rxOptPwrHigh2 (6) , rxOptPwrLow1 (7) , rxOptPwrLow2 (8) , noInputDetected1 (9) , noInputDetected2 (10) , reclockerLoss1 (11) , reclockerLoss2 (12) , txLaserFault1 (13) , txLaserFault2 (14) , sfpCommunicationLoss (15)

mgmtFaultPresent	Status		polling and trap	Check the status of fault(s)
SendMgmtTrap	Status	FC3405-MIB	polling and trap	Used to Turn Traps On and Off
trapValid	Status		polling and trap	Indicate if a particular trap is applicable to current SFP instance

Health monitoring alarms (*Continued*)

Alarm name	Type	MIB point	Polling or trap?	Further details
------------	------	-----------	------------------	-----------------

--- **Coax alarms** ---

All the following are elements related to signal output with type ASI.

Coax signals are on two channels Channel A and Channel B, the information displayed is done for both.

Tables of index : ChannelA (1) , ChannelB (2)

SignalRate	Text		polling and trap	Indicates the signal rate detected by the reclocker
SignalPresence	Status	FC3405-MIB	polling and trap	Indicates the signal presence on the indexed channel
SignalLock	Status		polling and trap	Indicates the status of the signal lock of the reclocker
CableEqualization	Text		polling and trap	Indicates the percentage of cable equalization of the indexed channel

Configurable parameters

Parameter	Description
<code>pollInterval</code>	Fast poller interval in seconds.
<code>retries</code>	If an SNMP request timeout, this defines the number of retries to be performed. Default is 1 .
<code>timeout</code>	Delay in seconds before declaring a timeout in the current SNMP request.
<code>uniqueID</code>	An extra identifier to be assigned to the plugin to differentiate its alarms from the other plugin of the same type. The <code>uniqueID</code> should be part of URI.
<code>readCommunity</code>	SNMP read community string. Use for SNMP polling.

3405FR-BNC

The Evertz 3405FR-BNC is a high-capacity bulk optical conversion platform. With the ability to accommodate 16 Evertz 3405-series SFP's, up to 32 optical to electrical or electrical to optical conversions may be performed in a single frame. Occupying only 1RU of rack space, the 3405FR-BNC is ideal for space-limited applications. The 3405FR-BNC can accommodate any 3405 series SFP, allowing the SFP cages to be populated as needed with optical transmit, receive, regenerator or electrical distribution amplifier SFPs. The SFP positions are not limited by function - any combination of 3405SFP types may be used, making countless versatile combinations possible. Benefits of fiber optics for video transport include longer attainable distances, smaller/lighter cabling, reduced cable tray loads and electrical isolation. The 3405FRBNC provides a low-overhead means for simple electrical/optical conversion for interfacility transport, as well as overcoming the limitations imposed by coaxial cable in intra-facility applications.

See the following for device support details:

- on page 62
- on page 70

Alarms

Alarm name	Type	Poll / Trap	Description	Alarm URI	MIB node name	OID
------------	------	-------------	-------------	-----------	---------------	-----

--- General alarms ---

External Power 1 Status	Status	Trap	Reports error with ext power 1	General/power1	FC3405-TRAPS	1488/1489
External Power 2 Status	Status	Trap	Reports error with ext power 2	General/power2	FC3405-TRAPS	1490/1491
Fan 1 Status	Status	Trap	Reports error with fan 1	General/fan1	FC3405-TRAPS	1480/1481
Fan 2 Status	Status	Trap	Reports error with fan 2	General/fan2	FC3405-TRAPS	1482/1483
Power Unit 1 Status	Status	Trap	Report error with psu1	General/psu1	FC3405-TRAPS	1484/1485
Power Unit 2 Status	Status	Trap	Report error with psu2	General/psu2	FC3405-TRAPS	1486/1485

--- Health Monitoring alarms ---

Communication Status	Status	Poll		Health_Monitoring/commStatus	RFC-1213	
Device Restart	Status	Poll		Health_Monitoring/deviceRestart	RFC-1213	
System Uptime	Text	Poll		Health_Monitoring/sysUpTime	RFC-1213	

--- Coaxial alarms ---

Cable Equalization	Text	Poll		[SFP]/[Channel]/cableEq	FC3405-MIB	coaxMonitorEntry.5
Input Detected	Status	Trap		[SFP]/[Channel]/inputDetect	FC3405-TRAPS	1256 - 1319
Signal Lock	Status	Poll		[SFP]/[Channel]/signalLock	FC3405-MIB	coaxMonitorEntry.3
Signal Presence	Status	Poll		[SFP]/[Channel]/signalPrse	FC3405-MIB	coaxMonitorEntry.2
Signal Rate	Text	Poll		[SFP]/[Channel]/signalRate	FC3405-MIB	coaxMonitorEntry.4

--- Rx alarms ---

Power High	Status	Trap		[SFP]/[Laser]/Rx/powerHigh	FC3405-TRAPS	1128-1191
------------	--------	------	--	----------------------------	--------------	-----------

Alarms (Continued)

Alarm name	Type	Poll / Trap	Description	Alarm URI	MIB node name	OID
Power Low	Status	Trap		[SFP]/[Laser]/Rx/powerLow	FC3405-TRAPS	1192 - 1255
Presence	Status	Trap		[SFP]/[Laser]/Rx/presence	FC3405-TRAPS	1064 - 1127
Received Optical Power	Text	Poll		[SFP]/[Laser]/Rx/laserPwr	FC3405-MIB	rxMonitorEntry.2
Reclock	Text	Poll		[SFP]/[Laser]/Rx/reclock	FC3405-MIB	rxMonitorEntry.3
Reclocker Locked	Status	Trap		[SFP]/[Laser]/Rx/reclockLock	FC3405-TRAPS	1320 - 1383

--- Tx alarms ---

Bias Current	Text	Poll		[SFP]/[Laser]/Tx/biasCurrent	FC3405-MIB	txMonitorEntry.2
Channel Status	Status	Poll		[SFP]/[Laser]/Tx/laserEn	FC3405-MIB	txMonitorEntry.3
Laser Fault	Status	Trap		[SFP]/[Laser]/Tx/laserFault	FC3405-TRAPS	1384 - 1447
Laser Status	Status	Poll		[SFP]/[Laser]/Tx/laserStatus	FC3405-MIB	txMonitorEntry.5
Presence	Status	Trap		[SFP]/[Laser]/Tx/presence	FC3405-TRAP	1000 - 1063
Reclock	Text	Poll		[SFP]/[Laser]/Tx/reclock	FC3405-MIB	txMonitorEntry.6
Wavelength	Text	Poll		[SFP]/[Laser]/Tx/wvLength	FC3405-MIB	txMonitorEntry.4

--- Monitor alarms ---

Class	Text	Poll		[SFP]/Monitor/class	FC3405-MIB	sfpMonitorEntry.2
Serial Number	Text	Poll		[SFP]/Monitor/serialNum	FC3405-MIB	sfpMonitorEntry.4
SFP Communication	Status	Trap		[SFP]/Monitor/sfpComm	FC3405-TRAP	1448 - 1479
Type	Text	Poll		[SFP]/Monitor/type	FC3405-MIB	sfpMonitorEntry.3
Upgrade Support	Status	Poll		[SFP]/Monitor/upgradeSupport	FC3405-MIB	sfpMonitorEntry.6
Version	Text	Poll		[SFP]/Monitor/version	FC3405-MIB	sfpMonitorEntry.5

Parameters

Parameter	Description	Default value	Configurable?
<code>pollInterval</code>	Poller interval in seconds. Overwrite the default interval.	10	NO
<code>retries</code>	If an SNMP request times out, this defines the number of retries to be performed.	2	NO
<code>timeout</code>	Delay in seconds before declaring a timeout in the current SNMP request.	5	NO
<code>uniqueID</code>	An extra identifier to be assigned to the plugin to differentiate its alarms from the other plugin of the same type. The uniqueID should be part of uri.		NO
<code>readCommunity</code>	SNMP read community string, used for SNMP polling.	public	NO
<code>writeCommunity</code>	SNMP write community string, used to send SNMP-set commands.	private	NO

3000MVP Multiviewer Platform



Evertz® 3000MVP Multiviewer platform

The Evertz® MVP is a 6RU multiviewer platform having 15 slots with each card capable of eight inputs and one output.

See the following for device support details:

- on page 49
- on page 61

Alarms

Alarm name	Type	Poll / Trap	MIB node name	Alarm URI	OID
--- Base-level alarms ---					
cardName	Both	Poll	cardName	snmp://{hostname}:3000MVP:{ip}/cardName	.1.3.6.1.4.1.6827.50.24.2.1
creationDate	Both	Poll	creationDate	snmp://{hostname}:3000MVP:{ip}/cardName	.1.3.6.1.4.1.6827.50.24.2.2
softwareRevisionMajor	Both	Poll	softwareRevisionMajor	snmp://{hostname}:3000MVP:{ip}/softwareRevisionMajor	.1.3.6.1.4.1.6827.50.24.2.3
softwareRevisionMinor	Both	Poll	softwareRevisionMinor	snmp://{hostname}:3000MVP:{ip}/softwareRevisionMinor	.1.3.6.1.4.1.6827.50.24.2.4
softwarePointReleaseNumber	Both	Poll	softwarePointReleaseNumber	snmp://{hostname}:3000MVP:{ip}/softwarePointReleaseNumber	.1.3.6.1.4.1.6827.50.24.2.5
softwareBuildNumber	Both	Poll	softwareBuildNumber	snmp://{hostname}:3000MVP:{ip}/softwareBuildNumber	.1.3.6.1.4.1.6827.50.24.2.6
firmwareLocation	Both	Poll	firmwareLocation	snmp://{hostname}:3000MVP:{ip}/firmwareLocation	.1.3.6.1.4.1.6827.50.24.3.1
boardSerialNumber	Both	Poll	boardSerialNumber	snmp://{hostname}:3000MVP:{ip}/boardSerialNumber	.1.3.6.1.4.1.6827.50.24.3.2
boardName	Both	Poll	boardName	snmp://{hostname}:3000MVP:{ip}/boardName	.1.3.6.1.4.1.6827.50.24.3.3
boardRevision	Both	Poll	boardRevision	snmp://{hostname}:3000MVP:{ip}/boardRevision	.1.3.6.1.4.1.6827.50.24.3.4
hardwareBuildNumber	Both	Poll	hardwareBuildNumber	snmp://{hostname}:3000MVP:{ip}/hardwareBuildNumber	.1.3.6.1.4.1.6827.50.24.3.5
--- Input alarms—Audio ---					
lossOfAudioCH1.<input>	Status	Both	faultPresentAudio	snmp://{hostname}:3000MVP:{ip}/lossOfAudioCH1.{input}	.1.3.6.1.4.1.6827.50.1.4.2.1.3.1.<input>
lossOfAudioCH2.<input>	Status	Both	faultPresentAudio	snmp://{hostname}:3000MVP:{ip}/lossOfAudioCH2.{input}	.1.3.6.1.4.1.6827.50.1.4.2.1.3.2.<input>
lossOfAudioCH3.<input>	Status	Both	faultPresentAudio	snmp://{hostname}:3000MVP:{ip}/lossOfAudioCH3.{input}	.1.3.6.1.4.1.6827.50.1.4.2.1.3.3.<input>

Alarms (Continued)

Alarm name	Type	Poll / Trap	MIB node name	Alarm URI	OID
lossOfAudioCH4.<input>	Status	Both	faultPresentAudio	snmp://{hostname}:3000 MVP:{ip}/lossOfAudioCH4.{input}	.1.3.6.1.4.1.6827.50.1.4.2.1.3.4.<input>
lossOfAudioCH5.<input>	Status	Both	faultPresentAudio	snmp://{hostname}:3000 MVP:{ip}/lossOfAudioCH5.{input}	.1.3.6.1.4.1.6827.50.1.4.2.1.3.5.<input>
lossOfAudioCH6.<input>	Status	Both	faultPresentAudio	snmp://{hostname}:3000 MVP:{ip}/lossOfAudioCH6.{input}	.1.3.6.1.4.1.6827.50.1.4.2.1.3.6.<input>
lossOfAudioCH7.<input>	Status	Both	faultPresentAudio	snmp://{hostname}:3000 MVP:{ip}/lossOfAudioCH7.{input}	.1.3.6.1.4.1.6827.50.1.4.2.1.3.7.<input>
lossOfAudioCH8.<input>	Status	Both	faultPresentAudio	snmp://{hostname}:3000 MVP:{ip}/lossOfAudioCH8.{input}	.1.3.6.1.4.1.6827.50.1.4.2.1.3.8.<input>
audioCH1Silence.<input>	Status	Both	faultPresentAudio	snmp://{hostname}:3000 MVP:{ip}/audioCH1Silence.{input}	.1.3.6.1.4.1.6827.50.1.4.2.1.3.9.<input>
audioCH2Silence.<input>	Status	Both	faultPresentAudio	snmp://{hostname}:3000 MVP:{ip}/audioCH2Silence.{input}	.1.3.6.1.4.1.6827.50.1.4.2.1.3.10.<input>
audioCH3Silence.<input>	Status	Both	faultPresentAudio	snmp://{hostname}:3000 MVP:{ip}/audioCH3Silence.{input}	.1.3.6.1.4.1.6827.50.1.4.2.1.3.11.<input>
audioCH4Silence.<input>	Status	Both	faultPresentAudio	snmp://{hostname}:3000 MVP:{ip}/audioCH4Silence.{input}	.1.3.6.1.4.1.6827.50.1.4.2.1.3.12.<input>
audioCH5Silence.<input>	Status	Both	faultPresentAudio	snmp://{hostname}:3000 MVP:{ip}/audioCH5Silence.{input}	.1.3.6.1.4.1.6827.50.1.4.2.1.3.13.<input>
audioCH6Silence.<input>	Status	Both	faultPresentAudio	snmp://{hostname}:3000 MVP:{ip}/audioCH6Silence.{input}	.1.3.6.1.4.1.6827.50.1.4.2.1.3.14.<input>
audioCH7Silence.<input>	Status	Both	faultPresentAudio	snmp://{hostname}:3000 MVP:{ip}/audioCH7Silence.{input}	.1.3.6.1.4.1.6827.50.1.4.2.1.3.15.<input>
audioCH8Silence.<input>	Status	Both	faultPresentAudio	snmp://{hostname}:3000 MVP:{ip}/audioCH8Silence.{input}	.1.3.6.1.4.1.6827.50.1.4.2.1.3.16.<input>
audioCH1Over.<input>	Status	Both	faultPresentAudio	snmp://{hostname}:3000 MVP:{ip}/audioCH1Over.{input}	.1.3.6.1.4.1.6827.50.1.4.2.1.3.17.<input>

Alarms (Continued)

Alarm name	Type	Poll / Trap	MIB node name	Alarm URI	OID
audioCH2Over.<input>	Status	Both	faultPresentAudio	snmp://{hostname}:3000 MVP:{ip}/audioCH2Over.{input}	.1.3.6.1.4.1.6827.50.1.4.2.1.3.18.<input>
audioCH3Over.<input>	Status	Both	faultPresentAudio	snmp://{hostname}:3000 MVP:{ip}/audioCH3Over.{input}	.1.3.6.1.4.1.6827.50.1.4.2.1.3.19.<input>
audioCH4Over.<input>	Status	Both	faultPresentAudio	snmp://{hostname}:3000 MVP:{ip}/audioCH4Over.{input}	.1.3.6.1.4.1.6827.50.1.4.2.1.3.20.<input>
audioCH5Over.<input>	Status	Both	faultPresentAudio	snmp://{hostname}:3000 MVP:{ip}/audioCH5Over.{input}	.1.3.6.1.4.1.6827.50.1.4.2.1.3.21.<input>
audioCH6Over.<input>	Status	Both	faultPresentAudio	snmp://{hostname}:3000 MVP:{ip}/audioCH6Over.{input}	.1.3.6.1.4.1.6827.50.1.4.2.1.3.22.<input>
audioCH7Over.<input>	Status	Both	faultPresentAudio	snmp://{hostname}:3000 MVP:{ip}/audioCH7Over.{input}	.1.3.6.1.4.1.6827.50.1.4.2.1.3.23.<input>
audioCH8Over.<input>	Status	Both	faultPresentAudio	snmp://{hostname}:3000 MVP:{ip}/audioCH8Over.{input}	.1.3.6.1.4.1.6827.50.1.4.2.1.3.24.<input>
phaseReversalLevel12.<input>	Status	Both	faultPresentAudio	snmp://{hostname}:3000 MVP:{ip}/phaseReversalLevel12.{input}	.1.3.6.1.4.1.6827.50.1.4.2.1.3.25.<input>
phaseReversalLevel34.<input>	Status	Both	faultPresentAudio	snmp://{hostname}:3000 MVP:{ip}/phaseReversalLevel34.{input}	.1.3.6.1.4.1.6827.50.1.4.2.1.3.26.<input>
phaseReversalLevel56.<input>	Status	Both	faultPresentAudio	snmp://{hostname}:3000 MVP:{ip}/phaseReversalLevel56.{input}	.1.3.6.1.4.1.6827.50.1.4.2.1.3.27.<input>
phaseReversalLevel78.<input>	Status	Both	faultPresentAudio	snmp://{hostname}:3000 MVP:{ip}/phaseReversalLevel78.{input}	.1.3.6.1.4.1.6827.50.1.4.2.1.3.28.<input>
audioMono12.<input>	Status	Both	faultPresentAudio	snmp://{hostname}:3000 MVP:{ip}/audioMono12.{input}	.1.3.6.1.4.1.6827.50.1.4.2.1.3.29.<input>
audioMono34.<input>	Status	Both	faultPresentAudio	snmp://{hostname}:3000 MVP:{ip}/audioMono34.{input}	.1.3.6.1.4.1.6827.50.1.4.2.1.3.30.<input>
audioMono56.<input>	Status	Both	faultPresentAudio	snmp://{hostname}:3000 MVP:{ip}/audioMono56.{input}	.1.3.6.1.4.1.6827.50.1.4.2.1.3.31.<input>

Alarms (Continued)

Alarm name	Type	Poll / Trap	MIB node name	Alarm URI	OID
audioMono78.<input>	Status	Both	faultPresentAudio	snmp://{hostname}:3000 MVP:{ip}/audioMono78.{input}	.1.3.6.1.4.1.6827.50.1.4.2.1.3.32.<input>

--- Input alarms—Audio-Video ---

lossOfNonPCMAudio12.<input>	Status	Both	faultPresentAudio	snmp://{hostname}:3000 MVP:{ip}/lossOfNonPCMAudio12.{input}	.1.3.6.1.4.1.6827.50.1.4.3.1.3.1.<input>
lossOfNonPCMAudio34.<input>	Status	Both	faultPresentAudio	snmp://{hostname}:3000 MVP:{ip}/lossOfNonPCMAudio34.{input}	.1.3.6.1.4.1.6827.50.1.4.3.1.3.2.<input>
lossOfNonPCMAudio56.<input>	Status	Both	faultPresentAudio	snmp://{hostname}:3000 MVP:{ip}/lossOfNonPCMAudio56.{input}	.1.3.6.1.4.1.6827.50.1.4.3.1.3.3.<input>
lossOfNonPCMAudio78.<input>	Status	Both	faultPresentAudio	snmp://{hostname}:3000 MVP:{ip}/lossOfNonPCMAudio78.{input}	.1.3.6.1.4.1.6827.50.1.4.3.1.3.4.<input>
lossOfEIA708Svc1.<input>	Status	Both	faultPresentAudio	snmp://{hostname}:3000 MVP:{ip}/lossOfEIA708Svc1.{input}	.1.3.6.1.4.1.6827.50.1.4.3.1.3.5.<input>
lossOfEIA708Svc2.<input>	Status	Both	faultPresentAudio	snmp://{hostname}:3000 MVP:{ip}/lossOfEIA708Svc2.{input}	.1.3.6.1.4.1.6827.50.1.4.3.1.3.6.<input>
lossOfEIA708Svc3.<input>	Status	Both	faultPresentAudio	snmp://{hostname}:3000 MVP:{ip}/lossOfEIA708Svc3.{input}	.1.3.6.1.4.1.6827.50.1.4.3.1.3.7.<input>
lossOfEIA708Svc4.<input>	Status	Both	faultPresentAudio	snmp://{hostname}:3000 MVP:{ip}/lossOfEIA708Svc4.{input}	.1.3.6.1.4.1.6827.50.1.4.3.1.3.8.<input>
lossOfEIA708Svc5.<input>	Status	Both	faultPresentAudio	snmp://{hostname}:3000 MVP:{ip}/lossOfEIA708Svc5.{input}	.1.3.6.1.4.1.6827.50.1.4.3.1.3.9.<input>
lossOfEIA708Svc6.<input>	Status	Both	faultPresentAudio	snmp://{hostname}:3000 MVP:{ip}/lossOfEIA708Svc6.{input}	.1.3.6.1.4.1.6827.50.1.4.3.1.3.10.<input>
lossOfEIA708Svc7.<input>	Status	Both	faultPresentAudio	snmp://{hostname}:3000 MVP:{ip}/lossOfEIA708Svc7.{input}	.1.3.6.1.4.1.6827.50.1.4.3.1.3.11.<input>
lossOfEIA708Svc8.<input>	Status	Both	faultPresentAudio	snmp://{hostname}:3000 MVP:{ip}/lossOfEIA708Svc8.{input}	.1.3.6.1.4.1.6827.50.1.4.3.1.3.12.<input>

Alarms (Continued)

Alarm name	Type	Poll / Trap	MIB node name	Alarm URI	OID
lossOfEIA708Svc9.<input>	Status	Both	faultPresentAudVid	snmp://{hostname}:3000 MVP:{ip}/lossOfEIA708Svc9.{input}	.1.3.6.1.4.1.6827.50.1.4.3.1.3.13.<input>
lossOfEIA708Svc10.<input>	Status	Both	faultPresentAudVid	snmp://{hostname}:3000 MVP:{ip}/lossOfEIA708Svc10.{input}	.1.3.6.1.4.1.6827.50.1.4.3.1.3.14.<input>
lossOfEIA708Svc11.<input>	Status	Both	faultPresentAudVid	snmp://{hostname}:3000 MVP:{ip}/lossOfEIA708Svc11.{input}	.1.3.6.1.4.1.6827.50.1.4.3.1.3.15.<input>
lossOfEIA708Svc12.<input>	Status	Both	faultPresentAudVid	snmp://{hostname}:3000 MVP:{ip}/lossOfEIA708Svc12.{input}	.1.3.6.1.4.1.6827.50.1.4.3.1.3.16.<input>
lossOfEIA708Svc13.<input>	Status	Both	faultPresentAudVid	snmp://{hostname}:3000 MVP:{ip}/lossOfEIA708Svc13.{input}	.1.3.6.1.4.1.6827.50.1.4.3.1.3.17.<input>
lossOfEIA708Svc14.<input>	Status	Both	faultPresentAudVid	snmp://{hostname}:3000 MVP:{ip}/lossOfEIA708Svc14.{input}	.1.3.6.1.4.1.6827.50.1.4.3.1.3.18.<input>
lossOfEIA708Svc15.<input>	Status	Both	faultPresentAudVid	snmp://{hostname}:3000 MVP:{ip}/lossOfEIA708Svc15.{input}	.1.3.6.1.4.1.6827.50.1.4.3.1.3.19.<input>
lossOfEIA708Svc16.<input>	Status	Both	faultPresentAudVid	snmp://{hostname}:3000 MVP:{ip}/lossOfEIA708Svc16.{input}	.1.3.6.1.4.1.6827.50.1.4.3.1.3.20.<input>
timecodeRctIGpi01.<input>	Status	Both	faultPresentAudVid	snmp://{hostname}:3000 MVP:{ip}/timecodeRctIGpi01.{input}	.1.3.6.1.4.1.6827.50.1.4.3.1.3.21.<input>
timecodeRctIGpi02.<input>	Status	Both	faultPresentAudVid	snmp://{hostname}:3000 MVP:{ip}/timecodeRctIGpi02.{input}	.1.3.6.1.4.1.6827.50.1.4.3.1.3.22.<input>
lossOfNAESSource.<input>	Status	Both	faultPresentAudVid	snmp://{hostname}:3000 MVP:{ip}/lossOfNAESSource.{input}	.1.3.6.1.4.1.6827.50.1.4.3.1.3.23.<input>
lossOfNAESData.<input>	Status	Both	faultPresentAudVid	snmp://{hostname}:3000 MVP:{ip}/lossOfNAESData.{input}	.1.3.6.1.4.1.6827.50.1.4.3.1.3.24.<input>
lossOfAMOLSource.<input>	Status	Both	faultPresentAudVid	snmp://{hostname}:3000 MVP:{ip}/lossOfAMOLSource.{input}	.1.3.6.1.4.1.6827.50.1.4.3.1.3.25.<input>
lossOfAMOLData.<input>	Status	Both	faultPresentAudVid	snmp://{hostname}:3000 MVP:{ip}/lossOfAMOLData.{input}	.1.3.6.1.4.1.6827.50.1.4.3.1.3.26.<input>

Alarms (Continued)

Alarm name	Type	Poll / Trap	MIB node name	Alarm URI	OID
timecodeRctIGpi03.<input>	Status	Both	faultPresentAudVid	snmp://{hostname}:3000 MVP:{ip}/timecodeRctIGpi03.{input}	.1.3.6.1.4.1.6827.50.1.4.3.1.3.27.<input>
timecodeRctIGpi04.<input>	Status	Both	faultPresentAudVid	snmp://{hostname}:3000 MVP:{ip}/timecodeRctIGpi04.{input}	.1.3.6.1.4.1.6827.50.1.4.3.1.3.28.<input>
timecodeRctIGpi05.<input>	Status	Both	faultPresentAudVid	snmp://{hostname}:3000 MVP:{ip}/timecodeRctIGpi05.{input}	.1.3.6.1.4.1.6827.50.1.4.3.1.3.29.<input>
timecodeRctIGpi06.<input>	Status	Both	faultPresentAudVid	snmp://{hostname}:3000 MVP:{ip}/timecodeRctIGpi06.{input}	.1.3.6.1.4.1.6827.50.1.4.3.1.3.30.<input>
lossOfSmpteAFD.<input>	Status	Both	faultPresentAudVid	snmp://{hostname}:3000 MVP:{ip}/lossOfSmpteAFD.{input}	.1.3.6.1.4.1.6827.50.1.4.3.1.3.31.<input>
macroBlkDetect.<input>	Status	Both	faultPresentAudVid	snmp://{hostname}:3000 MVP:{ip}/macroBlkDetect.{input}	.1.3.6.1.4.1.6827.50.1.4.3.1.3.32.<input>

--- Input alarms—Audio-Video 2 ---

futureUseAV200.<input>	Status	Both	faultPresentAudVid2	snmp://{hostname}:3000 MVP:{ip}/futureUseAV200.{input}	.1.3.6.1.4.1.6827.50.1.4.6.1.3.1.<input>
futureUseAV201.<input>	Status	Both	faultPresentAudVid2	snmp://{hostname}:3000 MVP:{ip}/futureUseAV201.{input}	.1.3.6.1.4.1.6827.50.1.4.6.1.3.2.<input>
futureUseAV202.<input>	Status	Both	faultPresentAudVid2	snmp://{hostname}:3000 MVP:{ip}/futureUseAV202.{input}	.1.3.6.1.4.1.6827.50.1.4.6.1.3.3.<input>
futureUseAV203.<input>	Status	Both	faultPresentAudVid2	snmp://{hostname}:3000 MVP:{ip}/futureUseAV203.{input}	.1.3.6.1.4.1.6827.50.1.4.6.1.3.4.<input>
futureUseAV204.<input>	Status	Both	faultPresentAudVid2	snmp://{hostname}:3000 MVP:{ip}/futureUseAV204.{input}	.1.3.6.1.4.1.6827.50.1.4.6.1.3.5.<input>
futureUseAV205.<input>	Status	Both	faultPresentAudVid2	snmp://{hostname}:3000 MVP:{ip}/futureUseAV205.{input}	.1.3.6.1.4.1.6827.50.1.4.6.1.3.6.<input>
futureUseAV206.<input>	Status	Both	faultPresentAudVid2	snmp://{hostname}:3000 MVP:{ip}/futureUseAV206.{input}	.1.3.6.1.4.1.6827.50.1.4.6.1.3.7.<input>

Alarms (Continued)

Alarm name	Type	Poll / Trap	MIB node name	Alarm URI	OID
futureUseAV207.<input>	Status	Both	faultPresentAudVid2	snmp://{hostname}:3000 MVP:{ip}/futureUseAV207.{input}	.1.3.6.1.4.1.6827.50.1.4.6.1.3.8.<input>
presenceOfTeletextGpi01.<input>	Status	Both	faultPresentAudVid2	snmp://{hostname}:3000 MVP:{ip}/presenceOfTeletextGpi01.{input}	.1.3.6.1.4.1.6827.50.1.4.6.1.3.9.<input>
presenceOfTeletextGpi02.<input>	Status	Both	faultPresentAudVid2	snmp://{hostname}:3000 MVP:{ip}/presenceOfTeletextGpi02.{input}	.1.3.6.1.4.1.6827.50.1.4.6.1.3.10.<input>
presenceOfTeletextGpi03.<input>	Status	Both	faultPresentAudVid2	snmp://{hostname}:3000 MVP:{ip}/presenceOfTeletextGpi03.{input}	.1.3.6.1.4.1.6827.50.1.4.6.1.3.11.<input>
presenceOfTeletextGpi04.<input>	Status	Both	faultPresentAudVid2	snmp://{hostname}:3000 MVP:{ip}/presenceOfTeletextGpi04.{input}	.1.3.6.1.4.1.6827.50.1.4.6.1.3.12.<input>
presenceOfTeletextGpi05.<input>	Status	Both	faultPresentAudVid2	snmp://{hostname}:3000 MVP:{ip}/presenceOfTeletextGpi05.{input}	.1.3.6.1.4.1.6827.50.1.4.6.1.3.13.<input>
presenceOfTeletextGpi06.<input>	Status	Both	faultPresentAudVid2	snmp://{hostname}:3000 MVP:{ip}/presenceOfTeletextGpi06.{input}	.1.3.6.1.4.1.6827.50.1.4.6.1.3.14.<input>
futureUseAV214.<input>	Status	Both	faultPresentAudVid2	snmp://{hostname}:3000 MVP:{ip}/futureUseAV214.{input}	.1.3.6.1.4.1.6827.50.1.4.6.1.3.15.<input>
futureUseAV215.<input>	Status	Both	faultPresentAudVid2	snmp://{hostname}:3000 MVP:{ip}/futureUseAV215.{input}	.1.3.6.1.4.1.6827.50.1.4.6.1.3.16.<input>
futureUseAV216.<input>	Status	Both	faultPresentAudVid2	snmp://{hostname}:3000 MVP:{ip}/futureUseAV216.{input}	.1.3.6.1.4.1.6827.50.1.4.6.1.3.17.<input>
futureUseAV217.<input>	Status	Both	faultPresentAudVid2	snmp://{hostname}:3000 MVP:{ip}/futureUseAV217.{input}	.1.3.6.1.4.1.6827.50.1.4.6.1.3.18.<input>
futureUseAV218.<input>	Status	Both	faultPresentAudVid2	snmp://{hostname}:3000 MVP:{ip}/futureUseAV218.{input}	.1.3.6.1.4.1.6827.50.1.4.6.1.3.19.<input>
futureUseAV219.<input>	Status	Both	faultPresentAudVid2	snmp://{hostname}:3000 MVP:{ip}/futureUseAV219.{input}	.1.3.6.1.4.1.6827.50.1.4.6.1.3.20.<input>
pplMaxError.<input>	Status	Both	faultPresentAudVid2	snmp://{hostname}:3000 MVP:{ip}/pplMaxError.{input}	.1.3.6.1.4.1.6827.50.1.4.6.1.3.21.<input>

Alarms (Continued)

Alarm name	Type	Poll / Trap	MIB node name	Alarm URI	OID
pplMinError.<input>	Status	Both	faultPresentAudVid2	snmp://{hostname}:3000 MVP:{ip}/pplMinError.{input}	.1.3.6.1.4.1.6827.50.1.4.6.1.3.22.<input>
futureUseAV222.<input>	Status	Both	faultPresentAudVid2	snmp://{hostname}:3000 MVP:{ip}/futureUseAV222.{input}	.1.3.6.1.4.1.6827.50.1.4.6.1.3.23.<input>
afdChange.<input>	Status	Both	faultPresentAudVid2	snmp://{hostname}:3000 MVP:{ip}/afdChange.{input}	.1.3.6.1.4.1.6827.50.1.4.6.1.3.24.<input>
videoIndexError.<input>	Status	Both	faultPresentAudVid2	snmp://{hostname}:3000 MVP:{ip}/videoIndexError.{input}	.1.3.6.1.4.1.6827.50.1.4.6.1.3.25.<input>
lossOfNonPCMAudio09.<input>	Status	Both	faultPresentAudVid2	snmp://{hostname}:3000 MVP:{ip}/lossOfNonPCMAudio09.{input}	.1.3.6.1.4.1.6827.50.1.4.6.1.3.26.<input>
lossOfNonPCMAudio1112.<input>	Status	Both	faultPresentAudVid2	snmp://{hostname}:3000 MVP:{ip}/lossOfNonPCMAudio1112.{input}	.1.3.6.1.4.1.6827.50.1.4.6.1.3.27.<input>
lossOfNonPCMAudio1314.<input>	Status	Both	faultPresentAudVid2	snmp://{hostname}:3000 MVP:{ip}/lossOfNonPCMAudio1314.{input}	.1.3.6.1.4.1.6827.50.1.4.6.1.3.28.<input>
lossOfNonPCMAudio1516.<input>	Status	Both	faultPresentAudVid2	snmp://{hostname}:3000 MVP:{ip}/lossOfNonPCMAudio1516.{input}	.1.3.6.1.4.1.6827.50.1.4.6.1.3.29.<input>
vidIdxChange.<input>	Status	Both	faultPresentAudVid2	snmp://{hostname}:3000 MVP:{ip}/vidIdxChange.{input}	.1.3.6.1.4.1.6827.50.1.4.6.1.3.30.<input>
futureUseAV230.<input>	Status	Both	faultPresentAudVid2	snmp://{hostname}:3000 MVP:{ip}/futureUseAV230.{input}	.1.3.6.1.4.1.6827.50.1.4.6.1.3.31.<input>
futureUseAV231.<input>	Status	Both	faultPresentAudVid2	snmp://{hostname}:3000 MVP:{ip}/futureUseAV231.{input}	.1.3.6.1.4.1.6827.50.1.4.6.1.3.32.<input>
lossOfAudioCH9.<input>	Status	Both	faultPresentAudio2	snmp://{hostname}:3000 MVP:{ip}/lossOfAudioCH9.{input}	.1.3.6.1.4.1.6827.50.1.4.7.1.3.1.<input>
lossOfAudioCH10.<input>	Status	Both	faultPresentAudio2	snmp://{hostname}:3000 MVP:{ip}/lossOfAudioCH10.{input}	.1.3.6.1.4.1.6827.50.1.4.7.1.3.2.<input>
lossOfAudioCH11.<input>	Status	Both	faultPresentAudio2	snmp://{hostname}:3000 MVP:{ip}/lossOfAudioCH11.{input}	.1.3.6.1.4.1.6827.50.1.4.7.1.3.3.<input>

Alarms (Continued)

Alarm name	Type	Poll / Trap	MIB node name	Alarm URI	OID
lossOfAudioCH12.<input>	Status	Both	faultPresentAudio2	snmp://{hostname}:3000 MVP:{ip}/lossOfAudioCH12.{input}	.1.3.6.1.4.1.6827.50.1.4.7.1.3.4.<input>
lossOfAudioCH13.<input>	Status	Both	faultPresentAudio2	snmp://{hostname}:3000 MVP:{ip}/lossOfAudioCH13.{input}	.1.3.6.1.4.1.6827.50.1.4.7.1.3.5.<input>
lossOfAudioCH14.<input>	Status	Both	faultPresentAudio2	snmp://{hostname}:3000 MVP:{ip}/lossOfAudioCH14.{input}	.1.3.6.1.4.1.6827.50.1.4.7.1.3.6.<input>
lossOfAudioCH15.<input>	Status	Both	faultPresentAudio2	snmp://{hostname}:3000 MVP:{ip}/lossOfAudioCH15.{input}	.1.3.6.1.4.1.6827.50.1.4.7.1.3.7.<input>
lossOfAudioCH16.<input>	Status	Both	faultPresentAudio2	snmp://{hostname}:3000 MVP:{ip}/lossOfAudioCH16.{input}	.1.3.6.1.4.1.6827.50.1.4.7.1.3.8.<input>
audioCH9Silence.<input>	Status	Both	faultPresentAudio2	snmp://{hostname}:3000 MVP:{ip}/audioCH9Silence.{input}	.1.3.6.1.4.1.6827.50.1.4.7.1.3.9.<input>
audioCH10Silence.<input>	Status	Both	faultPresentAudio2	snmp://{hostname}:3000 MVP:{ip}/audioCH10Silence.{input}	.1.3.6.1.4.1.6827.50.1.4.7.1.3.10.<input>
audioCH11Silence.<input>	Status	Both	faultPresentAudio2	snmp://{hostname}:3000 MVP:{ip}/audioCH11Silence.{input}	.1.3.6.1.4.1.6827.50.1.4.7.1.3.11.<input>
audioCH12Silence.<input>	Status	Both	faultPresentAudio2	snmp://{hostname}:3000 MVP:{ip}/audioCH12Silence.{input}	.1.3.6.1.4.1.6827.50.1.4.7.1.3.12.<input>
audioCH13Silence.<input>	Status	Both	faultPresentAudio2	snmp://{hostname}:3000 MVP:{ip}/audioCH13Silence.{input}	.1.3.6.1.4.1.6827.50.1.4.7.1.3.13.<input>
audioCH14Silence.<input>	Status	Both	faultPresentAudio2	snmp://{hostname}:3000 MVP:{ip}/audioCH14Silence.{input}	.1.3.6.1.4.1.6827.50.1.4.7.1.3.14.<input>
audioCH15Silence.<input>	Status	Both	faultPresentAudio2	snmp://{hostname}:3000 MVP:{ip}/audioCH15Silence.{input}	.1.3.6.1.4.1.6827.50.1.4.7.1.3.15.<input>
audioCH16Silence.<input>	Status	Both	faultPresentAudio2	snmp://{hostname}:3000 MVP:{ip}/audioCH16Silence.{input}	.1.3.6.1.4.1.6827.50.1.4.7.1.3.16.<input>
audioCH9Over.<input>	Status	Both	faultPresentAudio2	snmp://{hostname}:3000 MVP:{ip}/audioCH9Over.{input}	.1.3.6.1.4.1.6827.50.1.4.7.1.3.17.<input>

Alarms (Continued)

Alarm name	Type	Poll / Trap	MIB node name	Alarm URI	OID
audioCH10Over.<input>	Status	Both	faultPresentAudio2	snmp://{hostname}:3000 MVP:{ip}/audioCH10Over.{input}	.1.3.6.1.4.1.6827.50.1.4.7.1.3.18.<input>
audioCH11Over.<input>	Status	Both	faultPresentAudio2	snmp://{hostname}:3000 MVP:{ip}/audioCH11Over.{input}	.1.3.6.1.4.1.6827.50.1.4.7.1.3.19.<input>
audioCH12Over.<input>	Status	Both	faultPresentAudio2	snmp://{hostname}:3000 MVP:{ip}/audioCH12Over.{input}	.1.3.6.1.4.1.6827.50.1.4.7.1.3.20.<input>
audioCH13Over.<input>	Status	Both	faultPresentAudio2	snmp://{hostname}:3000 MVP:{ip}/audioCH13Over.{input}	.1.3.6.1.4.1.6827.50.1.4.7.1.3.21.<input>
audioCH14Over.<input>	Status	Both	faultPresentAudio2	snmp://{hostname}:3000 MVP:{ip}/audioCH14Over.{input}	.1.3.6.1.4.1.6827.50.1.4.7.1.3.22.<input>
audioCH15Over.<input>	Status	Both	faultPresentAudio2	snmp://{hostname}:3000 MVP:{ip}/audioCH15Over.{input}	.1.3.6.1.4.1.6827.50.1.4.7.1.3.23.<input>
audioCH16Over.<input>	Status	Both	faultPresentAudio2	snmp://{hostname}:3000 MVP:{ip}/audioCH16Over.{input}	.1.3.6.1.4.1.6827.50.1.4.7.1.3.24.<input>
phaseReversalLevel0910.<input>	Status	Both	faultPresentAudio2	snmp://{hostname}:3000 MVP:{ip}/phaseReversalLevel0910.{input}	.1.3.6.1.4.1.6827.50.1.4.7.1.3.25.<input>
phaseReversalLevel1112.<input>	Status	Both	faultPresentAudio2	snmp://{hostname}:3000 MVP:{ip}/phaseReversalLevel1112.{input}	.1.3.6.1.4.1.6827.50.1.4.7.1.3.26.<input>
phaseReversalLevel1314.<input>	Status	Both	faultPresentAudio2	snmp://{hostname}:3000 MVP:{ip}/phaseReversalLevel1314.{input}	.1.3.6.1.4.1.6827.50.1.4.7.1.3.27.<input>
phaseReversalLevel1516.<input>	Status	Both	faultPresentAudio2	snmp://{hostname}:3000 MVP:{ip}/phaseReversalLevel1516.{input}	.1.3.6.1.4.1.6827.50.1.4.7.1.3.28.<input>
audioMono0910.<input>	Status	Both	faultPresentAudio2	snmp://{hostname}:3000 MVP:{ip}/audioMono0910.{input}	.1.3.6.1.4.1.6827.50.1.4.7.1.3.29.<input>
audioMono1112.<input>	Status	Both	faultPresentAudio2	snmp://{hostname}:3000 MVP:{ip}/audioMono1112.{input}	.1.3.6.1.4.1.6827.50.1.4.7.1.3.30.<input>
audioMono1314.<input>	Status	Both	faultPresentAudio2	snmp://{hostname}:3000 MVP:{ip}/audioMono1314.{input}	.1.3.6.1.4.1.6827.50.1.4.7.1.3.31.<input>

Alarms (Continued)

Alarm name	Type	Poll / Trap	MIB node name	Alarm URI	OID
audioMono1516.<input>	Status	Both	faultPresentAudio2	snmp://{hostname}:3000 MVP:{ip}/audioMono1516.{input}	.1.3.6.1.4.1.6827.50.1.4.7.1.3.32.<input>

--- Video alarms ---

lossOfVideoSync.<input>	Status	Both	faultPresentVideo	snmp://{hostname}:3000 MVP:{ip}/lossOfVideoSync.{input}	.1.3.6.1.4.1.6827.50.1.4.1.1.3.1.<input>
lossOfVideoBurst.<input>	Status	Both	faultPresentVideo	snmp://{hostname}:3000 MVP:{ip}/lossOfVideoBurst.{input}	.1.3.6.1.4.1.6827.50.1.4.1.1.3.2.<input>
lossOfVideo.<input>	Status	Both	faultPresentVideo	snmp://{hostname}:3000 MVP:{ip}/lossOfVideo.{input}	.1.3.6.1.4.1.6827.50.1.4.1.1.3.3.<input>
maxAPLError.<input>	Status	Both	faultPresentVideo	snmp://{hostname}:3000 MVP:{ip}/maxAPLError.{input}	.1.3.6.1.4.1.6827.50.1.4.1.1.3.4.<input>
minAPLError.<input>	Status	Both	faultPresentVideo	snmp://{hostname}:3000 MVP:{ip}/minAPLError.{input}	.1.3.6.1.4.1.6827.50.1.4.1.1.3.5.<input>
apEDHError.<input>	Status	Both	faultPresentVideo	snmp://{hostname}:3000 MVP:{ip}/apEDHError.{input}	.1.3.6.1.4.1.6827.50.1.4.1.1.3.6.<input>
ffEDHError.<input>	Status	Both	faultPresentVideo	snmp://{hostname}:3000 MVP:{ip}/ffEDHError.{input}	.1.3.6.1.4.1.6827.50.1.4.1.1.3.7.<input>
videoTypeChange.<input>	Status	Both	faultPresentVideo	snmp://{hostname}:3000 MVP:{ip}/videoTypeChange.{input}	.1.3.6.1.4.1.6827.50.1.4.1.1.3.8.<input>
videoSourceChange.<input>	Status	Both	faultPresentVideo	snmp://{hostname}:3000 MVP:{ip}/videoSourceChange.{input}	.1.3.6.1.4.1.6827.50.1.4.1.1.3.9.<input>
apPictureFreeze.<input>	Status	Both	faultPresentVideo	snmp://{hostname}:3000 MVP:{ip}/apPictureFreeze.{input}	.1.3.6.1.4.1.6827.50.1.4.1.1.3.10.<input>
raPictureFreeze.<input>	Status	Both	faultPresentVideo	snmp://{hostname}:3000 MVP:{ip}/raPictureFreeze.{input}	.1.3.6.1.4.1.6827.50.1.4.1.1.3.11.<input>
apPictureMotion.<input>	Status	Both	faultPresentVideo	snmp://{hostname}:3000 MVP:{ip}/apPictureMotion.{input}	.1.3.6.1.4.1.6827.50.1.4.1.1.3.12.<input>

Alarms (Continued)

Alarm name	Type	Poll / Trap	MIB node name	Alarm URI	OID
raPictureMotion.<input>	Status	Both	faultPresentVideo	snmp://{hostname}:3000 MVP:{ip}/raPictureMotion.{input}	.1.3.6.1.4.1.6827.50.1.4.1.1.3.13.<input>
apPictureBlack.<input>	Status	Both	faultPresentVideo	snmp://{hostname}:3000 MVP:{ip}/apPictureBlack.{input}	.1.3.6.1.4.1.6827.50.1.4.1.1.3.14.<input>
raPictureBlack.<input>	Status	Both	faultPresentVideo	snmp://{hostname}:3000 MVP:{ip}/raPictureBlack.{input}	.1.3.6.1.4.1.6827.50.1.4.1.1.3.15.<input>
lossOfVITC.<input>	Status	Both	faultPresentVideo	snmp://{hostname}:3000 MVP:{ip}/lossOfVITC.{input}	.1.3.6.1.4.1.6827.50.1.4.1.1.3.16.<input>
lossOfSID.<input>	Status	Both	faultPresentVideo	snmp://{hostname}:3000 MVP:{ip}/lossOfSID.{input}	.1.3.6.1.4.1.6827.50.1.4.1.1.3.17.<input>
lossOfPR.<input>	Status	Both	faultPresentVideo	snmp://{hostname}:3000 MVP:{ip}/lossOfPR.{input}	.1.3.6.1.4.1.6827.50.1.4.1.1.3.18.<input>
lossOfCC1.<input>	Status	Both	faultPresentVideo	snmp://{hostname}:3000 MVP:{ip}/lossOfCC1.{input}	.1.3.6.1.4.1.6827.50.1.4.1.1.3.19.<input>
lossOfCC2.<input>	Status	Both	faultPresentVideo	snmp://{hostname}:3000 MVP:{ip}/lossOfCC2.{input}	.1.3.6.1.4.1.6827.50.1.4.1.1.3.20.<input>
lossOfCC3.<input>	Status	Both	faultPresentVideo	snmp://{hostname}:3000 MVP:{ip}/lossOfCC3.{input}	.1.3.6.1.4.1.6827.50.1.4.1.1.3.21.<input>
lossOfCC4.<input>	Status	Both	faultPresentVideo	snmp://{hostname}:3000 MVP:{ip}/lossOfCC4.{input}	.1.3.6.1.4.1.6827.50.1.4.1.1.3.22.<input>
lossOfText1.<input>	Status	Both	faultPresentVideo	snmp://{hostname}:3000 MVP:{ip}/lossOfText1.{input}	.1.3.6.1.4.1.6827.50.1.4.1.1.3.23.<input>
lossOfText2.<input>	Status	Both	faultPresentVideo	snmp://{hostname}:3000 MVP:{ip}/lossOfText2.{input}	.1.3.6.1.4.1.6827.50.1.4.1.1.3.24.<input>
lossOfText3.<input>	Status	Both	faultPresentVideo	snmp://{hostname}:3000 MVP:{ip}/lossOfText3.{input}	.1.3.6.1.4.1.6827.50.1.4.1.1.3.25.<input>
lossOfText4.<input>	Status	Both	faultPresentVideo	snmp://{hostname}:3000 MVP:{ip}/lossOfText4.{input}	.1.3.6.1.4.1.6827.50.1.4.1.1.3.26.<input>

Alarms (Continued)

Alarm name	Type	Poll / Trap	MIB node name	Alarm URI	OID
lossOfXDS.<input>	Status	Both	faultPresentVideo	snmp://{hostname}:3000MVP:{ip}/lossOfXDS.{input}	.1.3.6.1.4.1.6827.50.1.4.1.1.3.27.<input>
lossOfCCWaveform.<input>	Status	Both	faultPresentVideo	snmp://{hostname}:3000MVP:{ip}/lossOfCCWaveform.{input}	.1.3.6.1.4.1.6827.50.1.4.1.1.3.28.<input>
lossOfITCWaveform.<input>	Status	Both	faultPresentVideo	snmp://{hostname}:3000MVP:{ip}/lossOfITCWaveform.{input}	.1.3.6.1.4.1.6827.50.1.4.1.1.3.29.<input>
changeOfPR.<input>	Status	Both	faultPresentVideo	snmp://{hostname}:3000MVP:{ip}/changeOfPR.{input}	.1.3.6.1.4.1.6827.50.1.4.1.1.3.30.<input>
lossOfWST.<input>	Status	Both	faultPresentVideo	snmp://{hostname}:3000MVP:{ip}/lossOfWST.{input}	.1.3.6.1.4.1.6827.50.1.4.1.1.3.31.<input>
futureUse3.<input>	Status	Both	faultPresentVideo	snmp://{hostname}:3000MVP:{ip}/futureUse3.{input}	.1.3.6.1.4.1.6827.50.1.4.1.1.3.32.<input>

Parameters

Parameter	Description	Default value	Configurable?
alarmPath		"Evertz/3000MVP("+host+")"	NO
readCommunity	SNMP read community string, used for SNMP polling.	public	YES
writeCommunity	SNMP write community string, used to send SNMP-set commands.	private	YES
trapCommunity	SNMP trap community string, used to filter SNMP traps.	evertz	YES
pollInterval	Poller interval in seconds. Overwrite the default interval.	15	YES
snmpRefresh	Interval at which the SNMP OIDs will be refreshed (Interval to "get" OIDs).	300	YES
retries	If an SNMP request times out, this defines the number of retries to be performed.	2	YES
timeout	Delay in seconds before declaring a timeout in the current SNMP request.	5	YES
uniqueID	An extra identifier to be assigned to the plugin to differentiate its alarms from the other plugin of the same type. The uniqueID should be part of uri.	hostname	YES

Parameters (Continued)

Parameter	Description	Default value	Configurable?
<code>pollingPort</code>	Port to poll via SNMP get.	161	YES
<code>trapPort</code>	Port to receive traps.	162	YES
<code>numInputs</code>	Number of input ports on a card.	8	YES
<code>enableTrapsOnDevice</code>	Flag to enable setting of the OIDs which control the enabling/disabling of traps on the device.	false	YES

7700-Series Frame

The Evertz 7700-Series frame enables video and audio processing and distribution of HDTV, SDTV and analog signals.

7767VIP HSN



Evertz® VIP-series of multi-input display and signal monitoring products

The VIP™ series of multi-input display and signal monitoring products is ideally suited for dedicated signal monitoring applications with limited rackspace and/or number of signals. Ultimately displaying up to WUXGA (1920×1200) resolution the VIP™ modules accept up to 12 inputs and conveniently fit into Evertz's widely-installed, universal 7700FR-C frame. Furthermore, the VIP™ modules are also VistaLINK™-enabled, offering remote monitoring, control and configuration capabilities via Simple Network Management Protocol (SNMP). This product feature offers another solution to manage operations including signal monitoring and module configuration from SNMP-enabled control systems (Manager or NMS) locally or remotely.

See the following for device support details:

- on page 62
- on page 70

Alarms

Alarm name	Type	Poll / Trap	Alarm URI	MIB node name	OID
--- General Monitor alarms ---					
Firmware Version	Text	Poll	Monitor/firmwareVersion	<code>firmwareVersion</code>	

Alarms (Continued)

Alarm name	Type	Poll / Trap	Alarm URI	MIB node name	OID
GPI State #	Text	Poll	Monitor/roGPIState#	roGPIState	
Serial Num	Text	Poll	Monitor/serialNum	serialNum	

--- Video Channel Audio alarms ---

Audio Number Groups To Process	text	Poll	Video_Ch#/Audio/audioNumGroupsToProc	audioNumGroupsToProc	
Audio Source	text	Poll	Video_Ch#/Audio/audioSource	audioSource	

--- Audio Channel alarms ---

Audio Embedded Groups	text	Poll	Video_Ch#/AudioCh#/audioEmbeddedGroups	audioEmbeddedGroups	
Audio Loss Duration	text	Poll	Video_Ch#/AudioCh#/audioLossDuration	audioLossDuration	
Audio Loss Reset Duration	text	Poll	Video_Ch#/AudioCh#/audioLossResetDuration	audioLossResetDuration	
Audio Mono Duration	text	Poll	Video_Ch#/AudioCh#/audioMonoDuration	audioMonoDuration	
Audio Mono Level	text	Poll	Video_Ch#/AudioCh#/audioMonoLevel	audioMonoLevel	
Audio Mute Analog Channels	text	Poll	Video_Ch#/AudioCh#/audioMuteAnalogChannels	audioMuteAnalogChannels	
Audio Non PCM Loss Duration	text	Poll	Video_Ch#/AudioCh#/audioNonPCMLossDuration	audioNonPCMLossDuration	
Audio Non PCM Loss Duration Reset	text	Poll	Video_Ch#/AudioCh#/audioNonPCMLossDurationReset	audioNonPCMLossDurationReset	
Audio Over Analog Level	text	Poll	Video_Ch#/AudioCh#/audioOverAnalogLevel	audioOverAnalogLevel	
Audio Over Digital Level	text	Poll	Video_Ch#/AudioCh#/audioOverDigitalLevel	audioOverDigitalLevel	
Audio Over Duration	text	Poll	Video_Ch#/AudioCh#/audioOverDuration	audioOverDuration	
Audio Over Ratio	text	Poll	Video_Ch#/AudioCh#/audioOverRatio	audioOverRatio	

Alarms (Continued)

Alarm name	Type	Poll / Trap	Alarm URI	MIB node name	OID
Audio Over Reset Duration	text	Poll	Video_Ch#/Audio Ch#/audioOverResetDuration	audioOverResetDuration	
Audio Phase Reversal Duration	text	Poll	Video_Ch#/Audio Ch#/audioPhaseReversalDuration	audioPhaseReversalDuration	
Audio Phase Reversal Duration Reset	text	Poll	Video_Ch#/Audio Ch#/audioPhaseReversalDurationReset	audioPhaseReversalDurationReset	
Audio Phase Reversal Level	text	Poll	Video_Ch#/Audio Ch#/audioPhaseReversalLevel	audioPhaseReversalLevel	
Audio Silence Analog Level	text	Poll	Video_Ch#/Audio Ch#/audioSilenceAnalogLevel	audioSilenceAnalogLevel	
Audio Silence Digital Level	text	Poll	Video_Ch#/Audio Ch#/audioSilenceDigitalLevel	audioSilenceDigitalLevel	
Audio Silence Duration	text	Poll	Video_Ch#/Audio Ch#/audioSilenceDuration	audioSilenceDuration	
Audio Silence Reset Duration	text	Poll	Video_Ch#/Audio Ch#/audioSilenceResetDuration	audioSilenceResetDuration	
--- Audio Channel Monitor alarms ---					
Audio Data Error Region	text	Poll	Video_Ch#/Audio Ch#/roAudioDataErrRgn	roAudioDataErrRgn	
Audio Data PK	text	Poll	Video_Ch#/Audio Ch#/roAudioDataPK	roAudioDataPK	
Audio Data Reference Level	text	Poll	Video_Ch#/Audio Ch#/roAudioReferenceLevel	roAudioReferenceLevel	
Audio Data VU	text	Poll	Video_Ch#/Audio Ch#/roAudioDataVU	roAudioDataVU	
Audio Trend PK	text	Poll	Video_Ch#/Audio Ch#/roAudioTrendPK	roAudioTrendPK	
Audio Trend VU	text	Poll	Video_Ch#/Audio Ch#/roAudioTrendVU	roAudioTrendVU	
Non PCM Data Type	text	Poll	Video_Ch#/Audio Ch#/roNonPCMDatatype	roNonPCMDatatype	

Alarms (Continued)

Alarm name	Type	Poll / Trap	Alarm URI	MIB node name	OID
--- Video Channel Level Bar alarms ---					
Level Bar Analog Bar Type	text	Poll	Video_Ch#/LevelBar/levelBarAnalogBarType	levelBarAnalogBarType	
Level Bar Analog Error Region	text	Poll	Video_Ch#/LevelBar/levelBarAnalogErrorRegion	levelBarAnalogErrorRegion	
Level Bar Analog PPM Mode	text	Poll	Video_Ch#/LevelBar/levelBarAnalogPPMMode	levelBarAnalogPPMMode	
Level Bar Analog Reference Level	text	Poll	Video_Ch#/LevelBar/levelBarAnalogReferenceLevel	levelBarAnalogReferenceLevel	
Level Bar Digital Bar Type	text	Poll	Video_Ch#/LevelBar/levelBarDigitalBarType	levelBarDigitalBarType	
Level Bar Digital Error Region	text	Poll	Video_Ch#/LevelBar/levelBarDigitalErrorRegion	levelBarDigitalErrorRegion	
Level Bar Digital PPM Mode	text	Poll	Video_Ch#/LevelBar/levelBarDigitalPPMMode	levelBarDigitalPPMMode	
Level Bar Digital Reference Level	text	Poll	Video_Ch#/LevelBar/levelBarDigitalReferenceLevel	levelBarDigitalReferenceLevel	
--- Video Channel Monitor alarms ---					
Aspect Decode	text	Poll	Video_Ch#/Monitor/roAspectDecode	roAspectDecode	
Program Rating	text	Poll	Video_Ch#/Monitor/roProgramRating	roProgramRating	
SID Data	text	Poll	Video_Ch#/Monitor/roSIDData	roSIDData	
Video Standard	text	Poll	Video_Ch#/Monitor/roVideoStandard	roVideoStandard	
VITC Data	text	Poll	Video_Ch#/Monitor/roVITCData	roVITCData	
--- Video Channel Thumbnail alarms ---					
Thumbnail Enable Video	status	Poll	Video_Ch#/Thumbnail/thumbnailEnableVideo	tthumbnailEnableVideo	

Alarms (Continued)

Alarm name	Type	Poll / Trap	Alarm URI	MIB node name	OID
Thumbnail Size	text	Poll	Video_Ch#/Thumbnail/ThumbnailSize	thumbnailSize	
--- Video Channel Traps alarms ---					
APL Max	status	Trap	Video_Ch#/Traps/APLMax		
APL Min	status	Trap	Video_Ch#/Traps/APLMin		
Audio Channel#Loss	status	Trap	Video_Ch#/Traps/audioChannel#Loss		
Audio Channel#Over	status	Trap	Video_Ch#/Traps/audioChannel#Over		
Audio Channel#Silent	status	Trap	Video_Ch#/Traps/audioChannel#Silent		
Audio Pair##Mono	status	Trap	Video_Ch#/Traps/audioPair##Mono		
Audio Pair##Non PCM Data Invalid	status	Trap	Video_Ch#/Traps/audioPair##NonPCMDataInvalid		
Audio Pair##Phased	status	Trap	Video_Ch#/Traps/audioPair##Phased		
CC#Data Invalid	status	Trap	Video_Ch#/Traps/CC#DataInvalid		
CC Waveform Invalid	status	Trap	Video_Ch#/Traps/CCWaveformInvalid		
EDH Ap	status	Trap	Video_Ch#/Traps/edhAP		
EDH Ff	status	Trap	Video_Ch#/Traps/EDHFF		
Future Use Mixed Input#	status	Trap	Video_Ch#/Traps/futureUseMixedInput#		
GPI#	status	Trap	Video_Ch#/Traps/GPI#		
Program Rating Changed	status	Trap	Video_Ch#/Traps/programRatingChanged		
SID Data Invalid	status	Trap	Video_Ch#/Traps/SIDDataInvalid		
Teletext Loss	status	Trap	Video_Ch#/Traps/teletextLoss		
TXT#DataInvalid	status	Trap	Video_Ch#/Traps/TXT#DataInvalid		

Alarms (Continued)

Alarm name	Type	Poll / Trap	Alarm URI	MIB node name	OID
Video Active Picture Black	status	Trap	Video_Ch#/Traps/videoActivePictureBlack		
Video Active Picture Frozen	status	Trap	Video_Ch#/Traps/videoActivePictureFrozen		
Video Active Picture Motion	status	Trap	Video_Ch#/Traps/videoActivePictureMotion		
Video Burst Loss	status	Trap	Video_Ch#/Traps/videoBurstLoss		
Video Loss	status	Trap	Video_Ch#/Traps/videoLoss		
Video Region Black	status	Trap	Video_Ch#/Traps/videoRegionBlack		
Video Region Frozen	status	Trap	Video_Ch#/Traps/videoRegionFrozen		
Video Region Motion	status	Trap	Video_Ch#/Traps/videoRegionMotion		
Video Source Change	status	Trap	Video_Ch#/Traps/videoSourceChange		
Video Sync Loss	status	Trap	Video_Ch#/Traps/videoSyncLoss		
Video Type Change	status	Trap	Video_Ch#/Traps/videoTypeChange		
VITC Data Invalid	status	Trap	Video_Ch#/Traps/VITCDataInvalid		
VITC Waveform Invalid	status	Trap	Video_Ch#/Traps/VITCWaveformInvalid		
WSS Loss	status	Trap	Video_Ch#/Traps/WSSLoss		
XDS Data Invalid	status	Trap	Video_Ch#/Traps/XDSDataInvalid		

--- Video Channel alarms ---

Aspect Ratio Control	text	Poll	Video_Ch#/Video/aspectRatioControl	aspectRatioControl	
Auto Aspect Adjust	text	Poll	Video_Ch#/Video/autoAspectAdjust	autoAspectAdjust	
Black Duration	text	Poll	Video_Ch#/Video/blackDuration	blackDuration	
Black Duration Reset	text	Poll	Video_Ch#/Video/blackDurationReset	blackDurationReset	

Alarms (Continued)

Alarm name	Type	Poll / Trap	Alarm URI	MIB node name	OID
Cc#Loss Duration	text	Poll	Video_Ch#/Video/ccLossDuration	cc#LossDuration	
Cc#Loss Duration Reset	text	Poll	Video_Ch#/Video/ccLossDurationReset	cc#LossDurationReset	
Cc Channel Decoder	text	Poll	Video_Ch#/Video/ccChannelDecoder	ccChannelDecoder	
Cc Line Position	text	Poll	Video_Ch#/Video/ccLinePosition	ccLinePosition	
Cc Waveform Loss Duration	text	Poll	Video_Ch#/Video/ccWaveformLossDuration	ccWaveformLossDuration	
Cc Waveform Loss Duration Reset	text	Poll	Video_Ch#/Video/ccWaveformLossDurationReset	ccWaveformLossDurationReset	
Freeze Duration Reset	text	Poll	Video_Ch#/Video/freezeDurationReset	freezeDurationReset	
Freezemotion Duration	text	Poll	Video_Ch#/Video/freezemotionDuration	freezemotionDuration	
Hide CC Line	text	Poll	Video_Ch#/Video/hideCCLine	hideCCLine	
Max APL Duration	text	Poll	Video_Ch#/Video/maxAPLDuration	maxAPLDuration	
Max APL Duration Reset	text	Poll	Video_Ch#/Video/maxAPLDurationReset	maxAPLDurationReset	
Max APL Level	text	Poll	Video_Ch#/Video/minAPLLevel	minAPLLevel	
Min APL Duration	text	Poll	Video_Ch#/Video/minAPLDuration	minAPLDuration	
Min APL Duration Reset	text	Poll	Video_Ch#/Video/minAPLDurationReset	minAPLDurationReset	
Min APL Level	text	Poll	Video_Ch#/Video/minAPLLevel	minAPLLevel	
Monochrome Input	text	Poll	Video_Ch#/Video/monochromeInput	monochromeInput	
Motion Duration Reset	text	Poll	Video_Ch#/Video/motionDurationReset	motionDurationReset	
Noiselevel	text	Poll	Video_Ch#/Video/noiselevel	noiselevel	
PAL Mode	text	Poll	Video_Ch#/Video/palMode	palMode	

Alarms (Continued)

Alarm name	Type	Poll / Trap	Alarm URI	MIB node name	OID
Panel Color	text	Poll	Video_Ch#/Video/panelColor	panelColor	
Program Rating Loss Duration	text	Poll	Video_Ch#/Video/prLossDuration	prLossDuration	
Program Rating Loss Duration Reset	text	Poll	Video_Ch#/Video/prLossDurationReset	prLossDurationReset	
SID Data Loss Duration	text	Poll	Video_Ch#/Video/sidDataLossDuration	sidDataLossDuration	
SID Data Loss Duration Reset	text	Poll	Video_Ch#/Video/sidDataLossDurationReset	sidDataLossDurationReset	
Teletext Duration	text	Poll	Video_Ch#/Video/teletextDuration	teletextDuration	
Teletext Duration Reset	text	Poll	Video_Ch#/Video/teletextDurationReset	teletextDurationReset	
TXT#Loss Duration	text	Poll	Video_Ch#/Video/txt#LossDuration	txt#LossDuration	
TXT#Loss Duration Reset	text	Poll	Video_Ch#/Video/txt#LossDurationReset	txt#LossDurationReset	
Video EDH Error Duration	text	Poll	Video_Ch#/Video/vidEDHErrorDuration	vidEDHErrorDuration	
Video EDH Error Duration Reset	text	Poll	Video_Ch#/Video/vidEDHErrorDurationReset	vidEDHErrorDurationReset	
Video Loss Duration	text	Poll	Video_Ch#/Video/vidLossDuration	vidLossDuration	
Video Loss Duration Reset	text	Poll	Video_Ch#/Video/vidLossDurationReset	vidLossDurationReset	
Video Standard Change Duration	text	Poll	Video_Ch#/Video/vidstdChangeDuration	vidstdChangeDuration	
Video Standard Change Duration Reset	text	Poll	Video_Ch#/Video/vidstdChangeDurationReset	vidstdChangeDurationReset	
VITC Data Loss Duration	text	Poll	Video_Ch#/Video/vitcDataLossDuration	vitcDataLossDuration	
VITC Data Loss Duration Reset	text	Poll	Video_Ch#/Video/vitcDataLossDurationReset	vitcDataLossDurationReset	
VITC Line Position	text	Poll	Video_Ch#/Video/vitcLinePosition	vitcLinePosition	
VITC Waveform Loss Duration	text	Poll	Video_Ch#/Video/vitcWaveformLossDuration	vitcWaveformLossDuration	

Alarms (Continued)

Alarm name	Type	Poll / Trap	Alarm URI	MIB node name	OID
VITC Waveform Loss Duration Reset	text	Poll	Video_Ch#/Video/vitcWaveformLossDurationReset	vitcWaveformLossDurationReset	
WSS Line Position	text	Poll	Video_Ch#/Video/wssLinePosition	wssLinePosition	
WSS Loss Duration	text	Poll	Video_Ch#/Video/wssLossDuration	wssLossDuration	
WSS Loss Duration Reset	text	Poll	Video_Ch#/Video/wssLossDurationReset	wssLossDurationReset	
WSS Type	text	Poll	Video_Ch#/Video/wssType	wssType	
XDS Loss Duration	text	Poll	Video_Ch#/Video/xdsLossDuration	xdsLossDuration	
XDS Loss Duration Reset	text	Poll	Video_Ch#/Video/xdsLossDurationReset	xdsLossDurationReset	

Parameters

Parameter	Description	Default value	Configurable?
pollInterval	Poller interval in seconds. Overwrite the default interval.	10	NO
retries	If an SNMP request times out, this defines the number of retries to be performed.	2	NO
timeout	Delay in seconds before declaring a timeout in the current SNMP request.	5	NO
uniqueID	An extra identifier to be assigned to the plugin to differentiate its alarms from the other plugin of the same type. The uniqueID should be part of uri.		NO
readCommunity	SNMP read community string, used for SNMP polling.	public	NO
writeCommunity	SNMP write community string, used to send SNMP-set commands.	private	NO

7867VIPA-DUO

The 7867VIP Advanced is a multi-image display processor.

7707 VAT and VAR

Xenon Routing Switcher

Multi-format video routing switchers

EVS

Ordering information

Hardware	New in iControl version	GSM plug-in name	Order number
XT/XS-Series Video Servers		SNMP – EVS X-Series	IC-SNMP-185

XT/XS-Series Video Servers

XT- and XS-series video servers are production servers designed with advanced security features such as RAID technology, redundant and hot-swappable power supplies to guarantee no operational failures during production.

Global Caché

GC-100 Network Adapter

The GC-100 Network Adapter connects a network utilizing TCP/IP to infrared (IR), serial, relay and sensor inputs that can interrupt or be polled by another network device.

Grass Valley

Table 1: Ordering information

Hardware	New in iControl version	GSM plug-in name	Order number
7600 SPG , on page 73	6.20	SNMP – Grass Valley 7600 Sync Pulse Generator	
Application Server , on page 75			
Grass Valley Karrera Classic & Panel , on page 84			
iTx HP DL370 G6 Server , on page 95		SNMP – Miranda iTX HP DL Series	
iTX Supermicro , on page 95			
K2 Edge , on page 104	6.03	SNMP – Grass Valley K2 Edge for firmware 4.1	
		SNMP – Grass Valley K2 Edge for firmware 4.2	
K2 Solo Media Server , on page 114	6.03	SNMP – Grass Valley K2 Media Server	
K2 Summit Production Client , on page 118	6.03	SNMP – Grass Valley K2 Summit Production Client	
Kaleido-X , on page 121		Kaleido-X	
Grass Valley NV9000 System Controller , on page 122		SNMP – nVision NV9000	
Trinix , on page 123		SNMP – Grass Valley Trinix	IC-SNMP-092
Vertigo XG , on page 123	4.40	SNMP – Miranda Vertigo XG (Supermicro)	
vFlex Multi-purpose HD Video Data Inserter (formerly mfg'd by Softel) , on page 123«	6.02	SNMP – Softel vflex	IC-SNMP-254

7600 SPG

The Grass Valley 7600 is a Master Reference Generator designed for mixed SD and HD/3G installations. Along with enhanced 3G and GPS features, it includes test signal attributes for exposing delays and conversion issues in cabling. Advances in broadcast system design and developments in HD equipment have reduced the need for these types of signals. However, there can be exceptions. Independently timed SD and HD references together with appropriate test signals are still needed to resolve specific system design challenges.

Summary

- [7600 SPG Alarms](#), on page 73
- [7600 SPG Configurable Parameters](#), on page 75
- [7600 SPG MIBs Used](#), on page 75

7600 SPG Alarms

Alarm Name	Type	Poll / Trap	Description	URI Format
Communication Status	status	Poll	Communication status with the device	{baseuri}communicationStatus
GPO Trigger 1	Both	Poll	Reboot status of the device	{baseuri}/gpo1
GPO Trigger 2	Both	Poll	Total amount of memory available	{baseuri} /gpo2
Clock Output state	Both	Poll	Device Model	{baseuri}/settings_Clock_Output
LTC1 Enabled	Both	Poll	Management software build number	{baseuri}/settings_LTC1
LTC2 Enabled	Both	Poll	Management software global version	{baseuri}/settings_LTC2
SNMP Server Adress	Both	Poll	Management software name	{baseuri}/snmp_Server_Address
SNMP Trap Notification.	Both	Poll	Management software version	{baseuri}/snmp_Server_Notification_Enable
Backup Power Supply State	Both	Poll	Major number of the MIB version (In this case, the version is 5.9)	{baseuri}/state_Backup_Power_Supply
DHCP Server State	Both	Poll	Minor number of the MIB version (in this case, the version is 5.9)	{baseuri}/state_DHCP_Server
External 10Mhz State	Both	Poll	Operational state of the device	{baseuri}/state_Ext_10MHz

7600 SPG Alarms (continued)

Alarm Name	Type	Poll / Trap	Description	URI Format
Fan State	Both	Poll	Software revision of the firmware on the device	{baseuri}/state_Fan_Status
Genlock Input State	Both	Poll	Memory currently allocated for forward storage requests (kB)	{baseuri}/state_Genlock_Input
Genlock Sch State	Both	Poll	Total memory the bridge has reserved for forward storage requests (kB)	{baseuri}/state_Genlock_Sch
Genlock Video Standard State	Both	Poll	Storage bridge operational status	{baseuri}/state_Genlock_Video_Standard
GPS 1pps Lock State	Both	Poll	Storage bridge version descriptor	{baseuri}/state_GPS_1pps_Lock
GPS 1pps State	Both	Poll	Informative string pertaining the logical disk	{baseuri}/state_GPS_1pps
GPS Receiver	Both	Poll	Total space available on the logical disk (bytes)	{baseuri}/state_GPS_Receiver
GPS Serial State	Both	Poll	Amount of space used on the logical disk (bytes)	{baseuri}/state_GPS_Serial
GPS State	Both	Poll	Status of all amperage probes in the chassis	{baseuri}/state_GPS_Slot
GPS Visible Satellites	Both	Poll	Intrusion reading of all intrusion detection devices in the chassis	{baseuri}/state_Satellites_used
Line Lock State	Both	Poll	State of the chassis	{baseuri}/state_Line_Lock
NTP Server State	Both	Poll	System status of the chassis	{baseuri}/state_NTP_Server
S318 Presence State	Both	Poll	Status of all cooling devices in the chassis	{baseuri}/state_S318
Subcarrier Lock State	Both	Poll	System status of the cooling units in the chassis	{baseuri}/state_Subcarrier_Lock

7600 SPG Configurable Parameters

Parameter Name	Parameter Object Key	Description	Default Value
Poll Interval	pollInterval	Poller interval in seconds. Overwrite the default interval.	10 seconds
Retries	retries	If an SNMP request times out, this defines the number of retries to be performed.	0 retries
Timeout	timeout	Delay in seconds before declaring a timeout in the current SNMP request.	5 seconds
Read Community	readCommunity	SNMP read community string, used for SNMP polling.	"public"
Write Community	writeCommunity	SNMP write community string (password).	"public"

7600 SPG MIBs Used

MIB	MIB file name
Host Resources MIB	HOST-RESOURCES-MIB.mib
Trilogy MIB	Trilogy-MentorXL-MIB

Base URI for alarms

If an Application Server's hostname is *AppServer1*, and the IP address of the K2 Summit device is 10.12.170.141:
 snmp://10.12.170.141:7600_SPG/

Application Server**Summary**

[Introduction](#), on page 76

[Product Information](#), on page 76

[Key Features](#), on page 76

[Driver Details](#), on page 77

[Device Data and Emulation](#), on page 77

[Parameters](#), on page 77

[iControl App Server GSM Alarms](#), on page 78

[Device Data and Emulation](#), on page 85

Introduction

The Grass Valley iControl Application Server comes fully configured and ready for operation. No application software is required. Web pages and control applets are automatically loaded.

It provides unified control and detailed monitoring, as well as logging and interface services for multiple devices.

For critical applications, one or more mirror Application Servers can be used.

Product Information

The Grass Valley iControl Application Server is a dedicated server for iControl applications.

Key Features

Unifying Device Control

The Grass Valley iControl Application Server

- Unifies control of multiple Grass Valley and third-party devices via Ethernet, RS-422, and SNMP.
- Translates protocols and maps interfaces to IP for iControl.
- Provides local and remote access to all devices. It is designed for simple system installation and configuration.
- Acts as a store for all device drivers and workstation applications.
- Acts as web server for customized HTML network representations.

Fully Configured

- Ready for operation. No application software is required.
- Automatically loaded application web pages and control applets.
- Detailed monitoring.
- Advanced error reporting, logging, and SNMP reporting.
- Client connection statistics and administrative tools
- Retrievable profiles and configurations.
- Interrupt detection of streaming source and Event logging

Enterprise Grade

- Now available in an enterprise-grade version
- Designed for robust 24/7 operation
- Supports automatic failover to redundant servers
- For critical applications, achieves a higher level of redundancy by using one or more "mirror" Application Servers: N+1, or N+M redundancy is supported

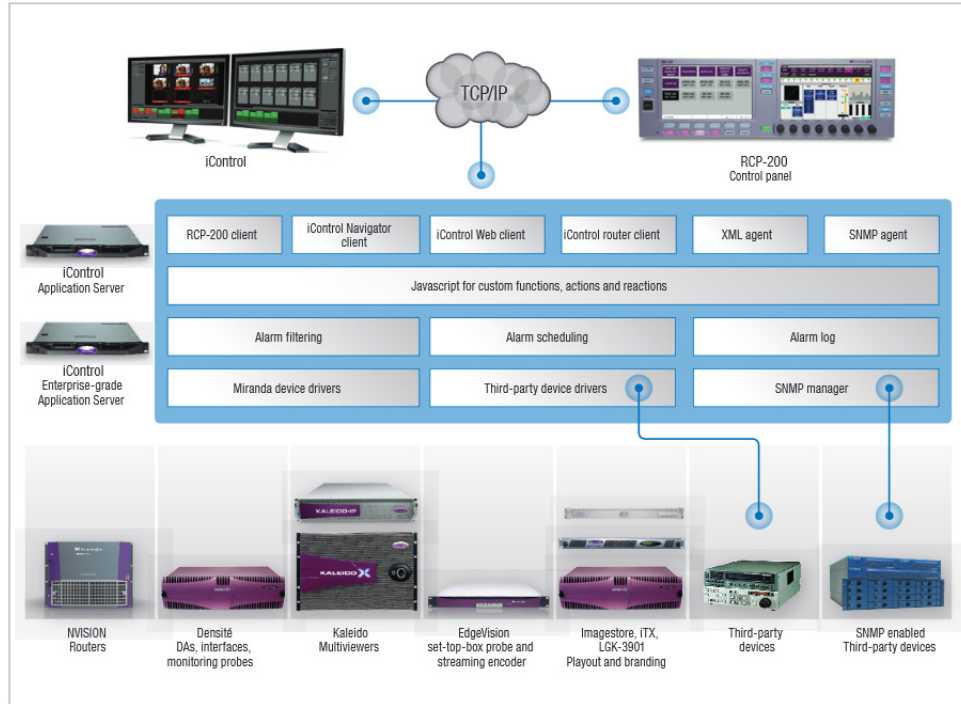

Driver Details

Driver Version	1.0
iControl Version	6.4
Firmware/Software Versions	
MIBs	
Original Project	
Solutions Device Type	

Device Data and Emulation

- Actual Two Power Supplies Device : 10.7.1.36
- Actual Single Power Supply device : 10.37.4.40

Parameters

iControl App Server Parameters that can be passed to the driver

Parameter	Description	Default Value	Configurable in GUI
pollerPollInterval	Poller interval in seconds. Overwrite the default interval.	30	Yes
pollerRetries	If an SNMP request times out, this defines the number of retries to be performed.	1	Yes

iControl App Server Parameters that can be passed to the driver

pollerTimeout	Delay in seconds before declaring a timeout in the current SNMP request.	20	Yes
readCommunity	SNMP read community string, used for SNMP polling.	public	Yes
writeCommunity	SNMP writecommunity string, used for SNMP polling.	public	Yes
pollerPort	We poll on that port see "/etc/snmp/snmpd.conf" file on AppServer	1161	No
numberOfPowerSupplies	The number of power supplies provided by the AppServer	1	Yes

iControl App Server GSM Alarms

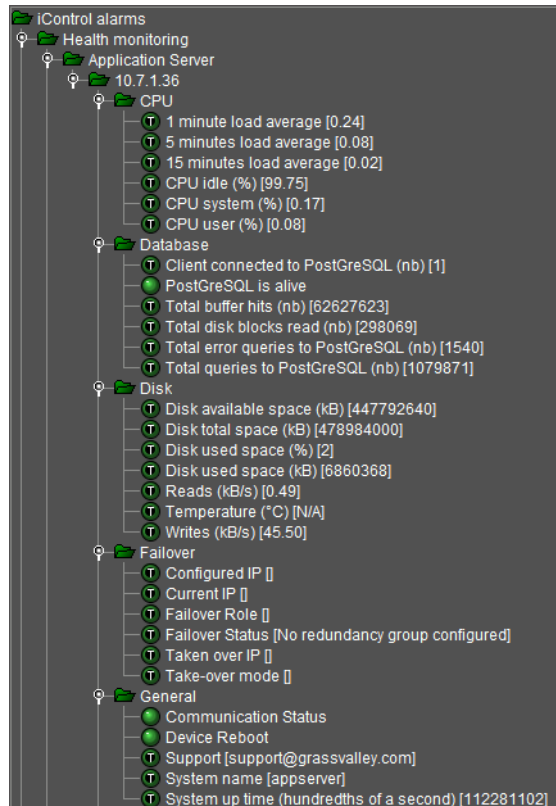

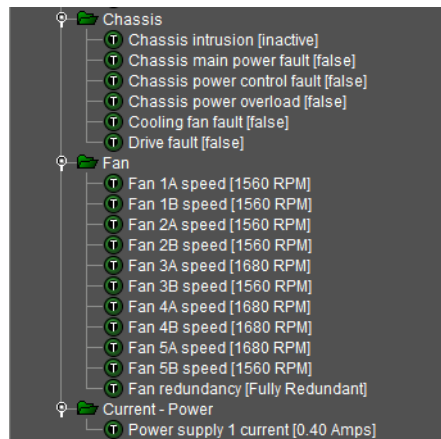
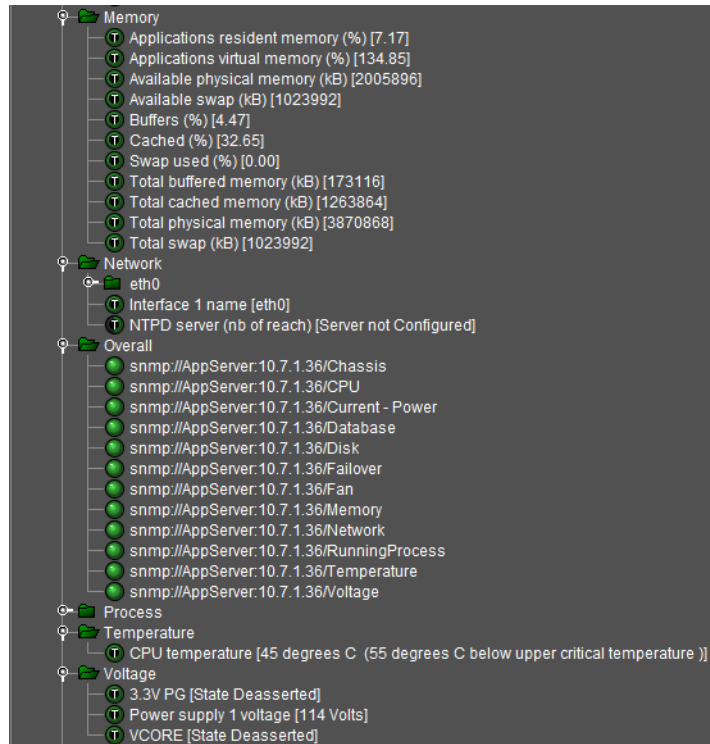

iControl App Server GSM Alarms

- **Base URI:** `snmp://AppServer:(DEVICE_IP)/`
- **Example:** `snmp://AppServer:10.7.1.36/FanSpeed03A`

The following table lists the alarms for the driver:

Miranda_AppServer_SystemMonitoring.js

Alarms list for the driver: `$(baseURI) example : snmp://AppServer:10.7.1.36`

Alarms for the Miranda_AppServer_SystemMonitoring.js Driver

GSM Alarm Name	Type	Poll/Trap	Index	Description	Alarm URI	MIB Node Name	OID
Communication Status	Status	Poll	NA	Set in alarm if the device is not reachable.	\$(baseURI)/commStatus	sysUpTime	
Device Reboot	Status	Poll	NA	If the device rebooted	\$(baseURI)/powerCycle	power	.1.3.6.1.4.1.31961.1.1.4
1 minute load average	Text/Status	Poll	NA	CPU load average for 1 minute	\$(baseURI)/oneMinuteLoad	oneMinuteLoadOID	.1.3.6.1.4.1.2021.1.0.1.3.1
5 minutes load average	Text/Status	Poll	NA	CPU load average for 5 minute	\$(baseURI)/fiveMinuteLoad	fiveMinuteLoadOID	.1.3.6.1.4.1.2021.1.0.1.3.2
15 minutes load average	Text/Status	Poll	NA	CPU load avg. for 15 minute	\$(baseURI)/fifteenMinuteLoad	fifteenMinuteLoadOID	.1.3.6.1.4.1.2021.10.1.3.3
CPU idle (%)	Text/Status	Poll	NA		\$(baseURI)/CPUidle	CPUIdleOID	.1.3.6.1.4.1.2021.8.1.101.123
CPU system (%)	Text/Status	Poll	NA		\$(baseURI)/CPUSystem	CPUSystemOID	.1.3.6.1.4.1.2021.8.1.101.125
CPU user (%)	Text/Status	Poll	NA		\$(baseURI)/CPUUser	CPUUserOID	.1.3.6.1.4.1.2021.8.1.101.124
Power supply 1 current	Text/Status	Poll	NA		\$(baseURI)/CurrentPsu1		.1.3.6.1.4.1.2021.8.1.101.90
Power supply 2 current	Text/Status	Poll	NA		\$(baseURI)/CurrentPsu2		.1.3.6.1.4.1.2021.8.1.101.91
Client connected to PostGreSQL (nb)	Text/Status	Poll	NA		\$(baseURI)/pgSQLNumClients	pgSQLNumClientsoID	.1.3.6.1.4.1.2021.8.1.101.3
PostGreSQL is alive	Text/Status	Poll	NA		\$(baseURI)/pgSQLisAlive	pgSQLisAliveOID	.1.3.6.1.4.1.2021.8.1.100.6

Alarms for the Miranda_AppServer_SystemMonitoring.js Driver

GSM Alarm Name	Type	Poll/Trap	Index	Description	Alarm URI	MIB Node Name	OID
Total buffer hits (nb)	Text/Status	Poll	NA		\$(baseURI)/pgSQLBlkHits	pgSQLBlkHitsOID	.1.3.6.1.4.1.2 021.8.1.101.2
Total disk blocks read (nb)	Text/Status	Poll	NA		\$(baseURI)/pgSQLBlkReads	pgSQLBlkReadsOID	.1.3.6.1.4.1.2 021.8.1.101.7
Total error queries to PostGreSQL (nb)	Text/Status	Poll	NA		\$(baseURI)/pgSQLErrorQueries	pgSQLErrorQueriesOID	.1.3.6.1.4.1.2 021.8.1.101.5
Total queries to PostGreSQL (nb)	Text/Status	Poll	NA		\$(baseURI)/pgSQLNumQueries	pgSQLNumQueriesOID	.1.3.6.1.4.1.2 021.8.1.101.4
Disk available space (kB)	Text/Status	Poll	NA		\$(baseURI)/DskAvailable	dskAvailableOID	.1.3.6.1.4.1.2 021.9.1.7.1
Disk total space (kB)	Text/Status	Poll	NA		\$(baseURI)/DskTotal	dskTotalOID	.1.3.6.1.4.1.2 021.9.1.6.1
Disk used space (%)	Text/Status	Poll	NA		\$(baseURI)/DskPercentUsed	dskPercentUsedOID	.1.3.6.1.4.1.2 021.9.1.9.1
Disk used space (kB)	Text/Status	Poll	NA		\$(baseURI)/DskUsed	dskUsedOID	.1.3.6.1.4.1.2 021.9.1.8.1
Reads (kB/s)	Text/Status	Poll	NA		\$(baseURI)/dskRead	dskReadOID	.1.3.6.1.4.1.2 021.8.1.101.30
Writes (kB/s)	Text/Status	Poll	NA		\$(baseURI)/dskWrite	dskWriteOID	.1.3.6.1.4.1.2 021.8.1.101.31
Temperature (°C)	Text/Status	Poll	NA	Disk temperature	\$(baseURI)/dskTemp	dskTempOID	.1.3.6.1.4.1.2 021.8.1.101.32
Fan (\$number)s peed	Text/Status	Poll	76 - 86		\$(baseURI)/FanSpeed01A		.1.3.6.1.4.1.2 021.8.1.101.
Applications resident memory (%)	Text/Status	Poll	NA		\$(baseURI)/ApplicationRSS		.1.3.6.1.4.1.2 021.8.1.101.26
Applications virtual memory (%)	Text/Status	Poll	NA		\$(baseURI)/ApplicationVSZ		.1.3.6.1.4.1.2 021.8.1.101.27

Alarms for the Miranda_AppServer_SystemMonitoring.js **Driver**

GSM Alarm Name	Type	Poll/Trap	Index	Description	Alarm URI	MIB Node Name	OID
Available physical memory (kB)	Text/Status	Poll	NA		\$(baseURI)/memAvailableReal		.1.3.6.1.4.1.2 021.4.6.0
Available swap (kB)	Text/Status	Poll	NA		\$(baseURI)/AvailableSwap		.1.3.6.1.4.1.2 021.4.4.0
Buffers (%)	Text/Status	Poll	NA		\$(baseURI)/memBuffersPercent		.1.3.6.1.4.1.2 021.8.1.101.9
Cached (%)	Text/Status	Poll	NA		\$(baseURI)/memCachedPercent		.1.3.6.1.4.1.2 021.8.1.101.8
Swap used (%)	Text/Status	Poll	NA		\$(baseURI)/memSwapPercent		.1.3.6.1.4.1.2 021.8.1.101.1
Total buffered memory (kB)	Text/Status	Poll	NA		\$(baseURI)/memBuffer		.1.3.6.1.4.1.2 021.4.14.0
Total cached memory (kB)	Text/Status	Poll	NA		\$(baseURI)/memCached		.1.3.6.1.4.1.2 021.4.15.0
Total physical memory (kB)	Text/Status	Poll	NA		\$(baseURI)/memTotalReal		.1.3.6.1.4.1.2 021.4.5.0
Total swap (kB)	Text/Status	Poll	NA		\$(baseURI)/TotalSwap		.1.3.6.1.4.1.2 021.4.3.0
CPU temperature	Text/Status	Poll	NA		\$(baseURI)/TempCpu_1		.1.3.6.1.4.1.2 021.8.1.101.39
3.3V PG	Text/Status	Poll	NA		\$(baseURI)/Voltage3_3		.1.3.6.1.4.1.2 021.8.1.101.49
Power supply 1 voltage	Text/Status	Poll	NA		\$(baseURI)/VoltagePsu1		.1.3.6.1.4.1.2 021.8.1.101.74

Alarms for the Miranda_AppServer_SystemMonitoring.js Driver

GSM Alarm Name	Type	Poll/Trap	Index	Description	Alarm URI	MIB Node Name	OID
Power supply 2 voltage	Text/Status	Poll	NA		\$(baseURI)/VoltagePsu2		.1.3.6.1.4.1.2021.8.1.101.75
VCORE	Text/Status	Poll	NA		\$(baseURI)/VoltageVcore		.1.3.6.1.4.1.2021.8.1.101.46

Setting up the iControl App Server Driver

Most parameters have default values. However, when you create the plugin, you can set custom values for parameters.

For example, if the App Server has two Power Supplies, you must change the Power Supplies parameter from **1** to **2**.

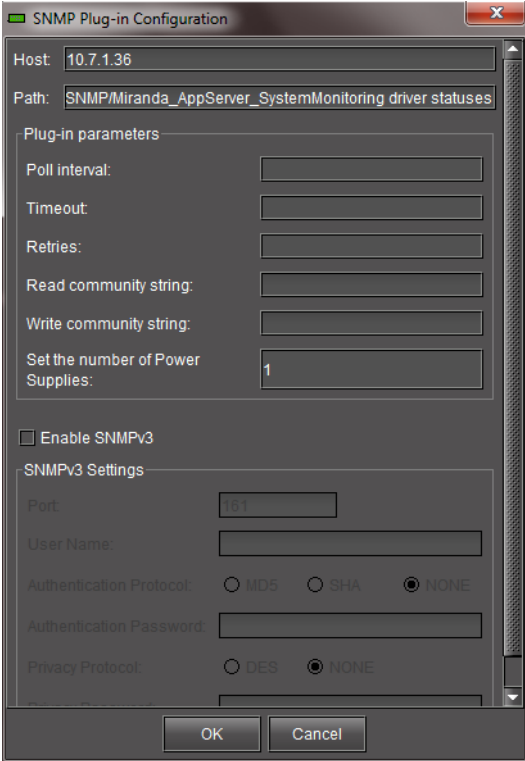

Grass Valley Karrera Classic & Panel



Summary

[Classic Karrera Driver Details](#), on page 85

[Classic Karrera Parameters that can be passed the Driver](#), on page 85

[Classic Karrera Device Data](#), on page 85

[Classic Karrera Alarms provided by driver](#), on page 87

[Karrera Panel Alarms provided by the driver](#), on page 91

Introduction

This driver page covers the two drivers made for the Karrera Classic Frame unit and the Control Panel unit.

Note: Each driver must be started individually.

Driver Details

This driver is implemented for the Grass Valley Karrera production switchers line of products this switcher comes with a control panel.

The table below provides details for each driver.

Classic Karrera Driver Details

Driver Name	Driver Version	iControl Version	Firmware/ Software Versions	MIBs	Solutions Device Type	License Code
GrassValley_Karrera_Classic.js	1.1	6.0.4		GVG-VSM-CLASSIC-MIB		8001
GrassValley_Karrera_Panel.js	1.1	6.0.4		GVG-GCP-MIB		8001

Device Data and Emulation

The Following table contains the IP address of the emulated devices used to test both drivers.

Classic Karrera Device Data

Driver	Emulated Device IP
Classic	10.12.172.95
Panel	10.12.172.96

The following link contains all the SNMP walk files used to develop the two drivers:

- [GVKarrera_WLK_files.rar](#)

Parameters

A table of parameters that can be passed to the drivers are found in the table below.

Classic Karrera Parameters that can be passed the Driver

Parameter	Description	Default Value	Configurable in GUI*
pollInterval	Poller interval in seconds. Overwrite the default interval.	30	No
SNMPrefresh	Refresh interval in seconds of the plugin.	120	No
retries	If an SNMP request times out, this defines the number of retries to be performed.	1	No
timeout	Delay in seconds before declaring a timeout in the current SNMP request.	5	No
uniqueID	An extra identifier to be assigned to the plugin to differentiate its alarms from the other plugin of the same type. The uniqueID should be part of uri.	""	No

Classic Karrera Parameters that can be passed the Driver

Parameter	Description	Default Value	Configurable in GUI*
readCommunity	SNMP read community string, used for SNMP polling.	public	No
writeCommunity	SNMP write community string, used to send SNMP-set commands.	private	No

*Configurable in GUI refers to whether or not the parameter is exposed in the GSM user interface when starting a new driver.

Classic Karrera Alarms

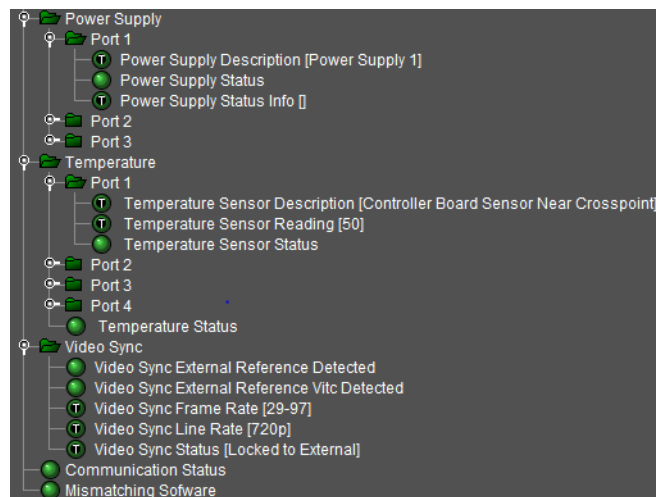
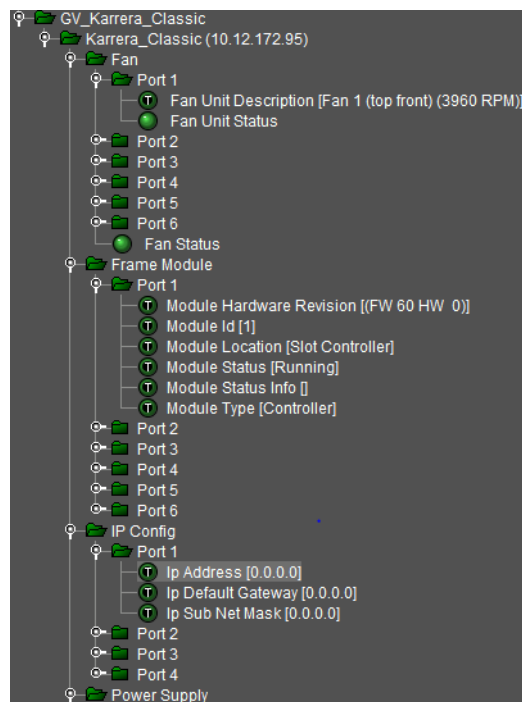

Alarms

Base URI: "snmp://Karrera_Classic:{deviceIP}/"

Table listing all available alarms provided by the driver

Classic Karrera Alarms provided by driver

GSM Alarm Name	Type	Poll/Trap	Description	Alarm URI	MIB node name	OID
Fan Unit Description	Status/Text	Poll	Informational: e.g. 'Left fan unit', replacement or serial numbers of the unit, or its current RPM readings	{Base URI}Fan/Port_1/vsmThFanUnitDescription	vsmThFanUnitDescription	.1.3.6.1.4.1.4947.2.5.1.1.2.1.3.1.3
Fan Unit Status	Status	Poll	Cooling fan status	{Base URI}Fan/Port_1/vsmThFanUnitStatus	vsmThFanUnitStatus	.1.3.6.1.4.1.4947.2.5.1.1.2.1.1
Module Hardware Revision	Status/Text	Poll	Hardware stepping number for a module	{Base URI}Frame_Module/Port_1/vsmModuleHwRev	vsmModuleHwRev	.1.3.6.1.4.1.4947.2.5.1.1.1.1.5
Module ID	Status/Text	Poll	Module ID of a module installed in the frame	{Base URI}Frame_Module/Port_1/vsmModuleId	vsmModuleId	.1.3.6.1.4.1.4947.2.5.1.1.1.1.4
Module Location	Status/Text	Poll	Additional information, e.g., Backplane designator if the switcher supports multiple backplanes or buses	{Base URI}Frame_Module/Port_1/vsmModuleLocation	vsmModuleLocation	.1.3.6.1.4.1.4947.2.5.1.1.1.1.2
Module Status	Status/Text	Poll	Operational status of a module	{Base URI}Frame_Module/Port_1/vsmModuleStatus	vsmModuleStatus	.1.3.6.1.4.1.4947.2.5.1.1.1.1.6
Module Status Info	Status/Text	Poll	Optional and auxiliary board status identifier	{Base URI}Frame_Module/Port_1/vsmModuleStatusInfo	vsmModuleStatusInfo	.1.3.6.1.4.1.4947.2.5.1.1.1.1.7

Classic Karrera Alarms provided by driver

GSM Alarm Name	Type	Poll/Trap	Description	Alarm URI	MIB node name	OID
Module Type	Status/Text	Poll	Description or type of module installed in a switcher frame	{Base URI}Frame_Module/Port_1/vsmModuleType	vsmModuleType	.1.3.6.1.4.1.4947.2.5.1.1.1.1.3
IP Address	Status/Text	Poll	Assigned IP host address. If the value is not configured, an IP of 0.0.0.0 is returned in an SnmpGetResponse message	{Base URI}IP_Config/Port_1/vsmIpAddress	vsmIpAddress	.1.3.6.1.4.1.4947.2.5.1.3.1.1.2
IP Default Gateway	Status/Text	Poll	Assigned default gateway IP address. If the value is not configured, an IP of 0.0.0.0 is returned in an SnmpGetResponse message	{Base URI}IP_Config/Port_1/vsmIpDefaultGateway	vsmIpDefaultGateway	.1.3.6.1.4.1.4947.2.5.1.3.1.1.4
IP Subnet Mask	Status/Text	Poll	Assigned IP subnet mask. If the value is not configured, an IP of 0.0.0.0 is returned in an SnmpGetResponse message."	{Base URI}IP_Config/Port_1/vsmIpSubNetMask	vsmIpSubNetMask	.1.3.6.1.4.1.4947.2.5.1.3.1.1.3
Power Supply Description	Status/Text	Poll	Description of the power supply or power supply provision	{Base URI}Power_Supply/Port_1/vsmPsDescription	vsmPsDescription	.1.3.6.1.4.1.4947.2.5.1.1.2.2.1.3
Power Supply Status	Status	Poll	Status of each power supply unit provision for the switcher frame and modules	{Base URI}Power_Supply/Port_1/vsmPsStatus	vsmPsStatus	.1.3.6.1.4.1.4947.2.5.1.1.2.2.1.2
Power Supply Info	Status/Text	Poll	Support for this object is optional where the agent can always return an empty string	{Base URI}Power_Supply/Port_1/vsmPsStatusInfo	vsmPsStatusInfo	.1.3.6.1.4.1.4947.2.5.1.1.2.2.1.4

Classic Karrera Alarms provided by driver

GSM Alarm Name	Type	Poll/Trap	Description	Alarm URI	MIB node name	OID
Temperature Sensor Description	Status/Text	Poll	A description of the sensor	{Base URI}Temperature/Port_1/vsmThTempSensorDescription	vsmThTempSensorDescription	.1.3.6.1.4.1.4947.2.5.1.1.2.1.4.1.3
Temperature Sensor Reading	Status/Text	Poll	Reading of the temperature sensor in degrees Centigrade	{Base URI}Temperature/Port_1/vsmThTempSensorReading	vsmThTempSensorReading	.1.3.6.1.4.1.4947.2.5.1.1.2.1.4.1.4
Temperature Status	Status	Poll	Temperature status as monitored by the system. Based on the reading obtained from the specific sensor	{Base URI}Temperature/Port_1/vsmThTempSensorStatus	vsmThTempSensorStatus	.1.3.6.1.4.1.4947.2.5.1.1.2.1.4.1.2
Video Sync External Reference Detected	Status	Poll	Indicates whether an external timing reference signal is detected	{Base URI}Video_Sync//vsmVsExtRefDetected	vsmVsExtRefDetected	.1.3.6.1.4.1.4947.2.5.1.2.1.3
Video Sync External Reference Vitc Detected	Status	Poll	Indicates whether VITC was detected in the external timing reference signal	{Base URI}Video_Sync//vsmVsExtRefVitcDetected	vsmVsExtRefVitcDetected	.1.3.6.1.4.1.4947.2.5.1.2.1.4
Video Sync Frame Rate	Status/Text	Poll	Frame rate of the video standard used on the system	{Base URI}Video_Sync//vsmVsFrameRate	vsmVsFrameRate	.1.3.6.1.4.1.4947.2.5.1.2.1.2
Video Sync Line rate	Status/Text	Poll	Line rate of the video standard used on the system	{Base URI}Video_Sync//vsmVsLineRate	vsmVsLineRate	.1.3.6.1.4.1.4947.2.5.1.2.1.1
Video Sync Status	Status/Text	Poll	Indicates whether the system timing is locked to the external timing reference signal	{Base URI}Video_Sync//vsmVsStatus	vsmVsStatus	.1.3.6.1.4.1.4947.2.5.1.2.1.5

Classic Karrera Alarms provided by driver

GSM Alarm Name	Type	Poll/Trap	Description	Alarm URI	MIB node name	OID
Communication Status	Status	Poll	Device communication alarm set by receiving a successful/failed event in the poller	{Base URI}//communicationStatus	N/A	N/A
Mismatching Software	Status	Trap	Trap sent if components connected to the video switcher processor are running mismatching or incompatible software.	{Base URI}//mismatchingSoftware	N/A	.1.3.6.1.4.1.4947.2.5.1.0.7

Panel Karrera Alarms

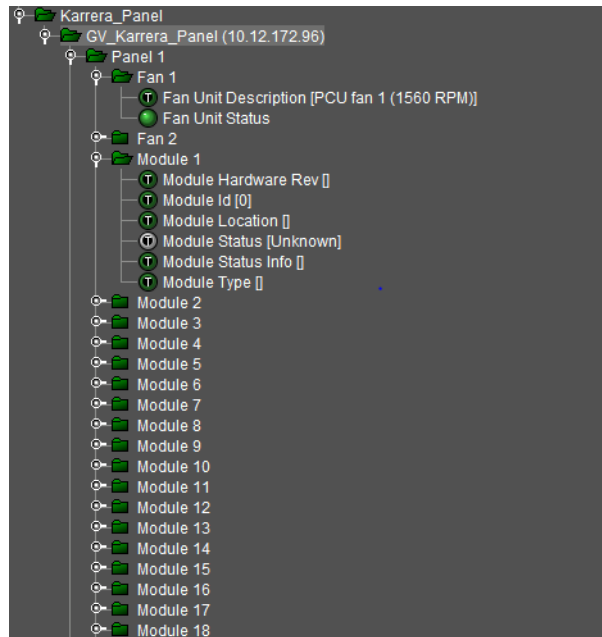

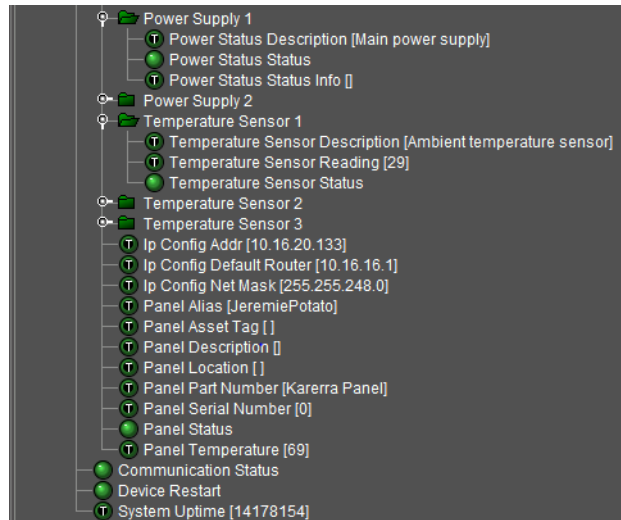

Alarms

Base URI: `snmp://GV_Karrera_Panel:{Device IP}/`

Karrera Panel Alarms provided by the driver

GSM Alarm Name	Type	Poll/Trap	Description	Alarm URI	MIB node name	OID
Fan Unit Description	Status/Text	Poll	Informational: e.g. 'Left fan unit', replacement or serial numbers of the unit, or its current RPM readings	{Base URI}Fan/Port_1/gcpThFanUnitDescription	gcpThFanUnitDescription	.1.3.6.1.4.1.4947.2.5.1.1.2.1.3.1.3
Fan Unit Status	Status	Poll	Cooling fan status	{Base URI}Fan/Port_1/gcpThFanUnitStatus	gcpThFanUnitStatus	.1.3.6.1.4.1.4947.2.5.1.1.2.1.1
Module Hardware Revision	Status/Text	Poll	Hardware stepping number for a module	{Base URI}Frame_Module/Port_1/gcpModuleHwRev	gcpModuleHwRev	.1.3.6.1.4.1.4947.2.5.1.1.1.1.5
Module ID	Status/Text	Poll	Module ID of a module installed in the frame	{Base URI}Frame_Module/Port_1/gcpModuleId	gcpModuleId	.1.3.6.1.4.1.4947.2.5.1.1.1.1.4

Karrera Panel Alarms provided by the driver

GSM Alarm Name	Type	Poll/Trap	Description	Alarm URI	MIB node name	OID
Module Location	Status/Text	Poll	Additional information, e.g., Backplane designator if the switcher supports multiple backplanes or buses	{Base URI}Frame_Module/Port_1/gcpModuleLocation	gcpModuleLocation	.1.3.6.1.4.1.4947.2.5.1.1.1.1.2
Module Status	Status/Text	Poll	Operational status of a module	{Base URI}Frame_Module/Port_1/gcpModuleStatus	gcpModuleStatus	.1.3.6.1.4.1.4947.2.5.1.1.1.1.6
Module Status Info	Status/Text	Poll	Optional and auxiliary board status identifier	{Base URI}Frame_Module/Port_1/gcpModuleStatusInfo	gcpModuleStatusInfo	.1.3.6.1.4.1.4947.2.5.1.1.1.1.7
Module Type	Status/Text	Poll	Description or type of module installed in a switcher frame	{Base URI}Frame_Module/Port_1/gcpModuleType	gcpModuleType	.1.3.6.1.4.1.4947.2.5.1.1.1.1.3
Power Supply Description	Status/Text	Poll	Description of the power supply or power supply provision	{Base URI}Power_Supply/Port_1/gcpPsDescription	gcpPsDescription	.1.3.6.1.4.1.4947.2.5.1.1.2.2.1.3
Power Supply Status	Status	Poll	Status of each power supply unit provision for the switcher frame and modules	{Base URI}Power_Supply/Port_1/gcpPsStatus	gcpPsStatus	.1.3.6.1.4.1.4947.2.5.1.1.2.2.1.2
Power Supply Info	Status/Text	Poll	Support for this object is optional where the agent can always return an empty string	{Base URI}Power_Supply/Port_1/gcpPsStatusInfo	gcpPsStatusInfo	.1.3.6.1.4.1.4947.2.5.1.1.2.2.1.4
Temperature Sensor Description	Status/Text	Poll	A description of the sensor	{Base URI}Temperature/Port_1/gcpThTempSensorDescription	gcpThTempSensorDescription	.1.3.6.1.4.1.4947.2.5.1.1.2.1.4.1.3
Temperature Sensor Reading	Status/Text	Poll	Reading of the temperature sensor in degrees Centigrade	{Base URI}Temperature/Port_1/gcpThTempSensorReading	gcpThTempSensorReading	.1.3.6.1.4.1.4947.2.5.1.1.2.1.4.1.4

Karrera Panel Alarms provided by the driver

GSM Alarm Name	Type	Poll/Trap	Description	Alarm URI	MIB node name	OID
Temperature Status	Status	Poll	Temperature status as monitored by the system. Based on the reading obtained from the specific sensor	{Base URI}Temperature/Port_1/gcpThTempSensorStatus	gcpThTempSensorStatus	.1.3.6.1.4 .1.4947.2. 5.1.1.2.1. 4.1.2
IP Address	Status/Text	Poll	Assigned IP host address. If the value is not configured, an IP of 0.0.0.0 is returned in an SnmpGetResponse message	{Base URI}IP_Config/Port_1/gcpIpAddress	gcpIpAddress	.1.3.6.1.4 .1.4947.2. 5.1.3.1.1. 2
IP Default Gateway	Status/Text	Poll	Assigned default gateway IP address. If the value is not configured, an IP of 0.0.0.0 is returned in an SnmpGetResponse message	{Base URI}IP_Config/Port_1/gcpIpDefaultGateway	gcpIpDefaultGateway	.1.3.6.1.4 .1.4947.2. 5.1.3.1.1. 4
IP Subnet Mask	Status/Text	Poll	Assigned IP subnet mask. If the value is not configured, an IP of 0.0.0.0 is returned in an SnmpGetResponse message."	{Base URI}IP_Config/Port_1/gcpIpSubNetMask	gcpIpSubNetMask	.1.3.6.1.4 .1.4947.2. 5.1.3.1.1. 3
Panel Alias	Poll	Status/Text	Poll	{Base URI}Panel_1/gcpPanelAlias	gcpPanelAlias	.1.3.6.1.4 .1.4947.2. 6.1.1.2
Panel Asset tag	SSStatus/Text	Poll	The object is a user-assigned asset tracking identifier for the physical panel, providing non-volatile storage of this information	{Base URI}Panel_1/gcpPanelAssetTag	gcpPanelAssetTag	.1.3.6.1.4 .1.4947.2. 6.1.1.8

Karrera Panel Alarms provided by the driver

GSM Alarm Name	Type	Poll/Trap	Description	Alarm URI	MIB node name	OID
Panel Description	Status/Text	Poll	Control panel textual description	{Base URI}Panel_1/gcpPanelDescription	gcpPanelDescription	.1.3.6.1.4 .1.4947.2. 6.1.1.3
Panel Location	Status/Text	Poll	The object is a user-assigned physical location identifier of the panel as specified by the network manager, providing non-volatile storage of this information.	{Base URI}Panel_1/gcpPanelLocation	cpPanelLocation'	.1.3.6.1.4 .1.4947.2. 6.1.1.6
Panel Part Number	Status/Text	Poll	Vendor-specific model name identifier string associated with this physical panel	{Base URI}Panel_1/gcpPanelPartNumber	gcpPanelPartNumber	.1.3.6.1.4 .1.4947.2. 6.1.1.5
Panel Serial Number	Status/Text	Poll	Vendor-specific serial number string for the panel	{Base URI}Panel_1/gcpPanelSerialNumber	gcpPanelSerialNumber	.1.3.6.1.4 .1.4947.2. 6.1.1.4
Panel Status	Status	Poll	Operational status of a panel	{Base URI}Panel_1/gcpPanelStatus	gcpPanelStatus	.1.3.6.1.4 .1.4947.2. 6.1.1.7
Panel temperature	Status/Text	Poll	Approximate temperature in the panel mechanical enclosure in centigrade	{Base URI}Panel_1/gcpPanelTemperature	gcpPanelTemperature	.1.3.6.1.4 .1.4947.2. 6.1.1.9
Communication Status	Status	Poll	Device communication alarm set by receiving a successful/failed event in the poller	{Base URI}//communicationStatus	N/A	N/A

Karrera Panel Alarms provided by the driver

GSM Alarm Name	Type	Poll/Trap	Description	Alarm URI	MIB node name	OID
Device Restart	Status	Poll	Device power cycle alarm status determined comparing subsequent polling of the system up time variable	snmp://Panacea:{IPADDRESS}/powerCycle	sysUpTime (RFC1213)	N/A
System uptime	Status/Text	Poll	System up time alarm. A default health monitoring alarm used with the generic.js to create a new custom driver	snmp://Panacea:{IPADDRESS}/powerCycle	sysUpTime (RFC1213)	N/A

iTx HP DL370 G6 Server

Server for iTX's IT-based playout of linear and on-demand television.

iTX Supermicro**Summary**

[iTX Supermicro Driver Details, on page 96](#)

[Table listing all available alarms provided by the Appliance 2, on page 99](#)

Key Information

Table 2: iTX Supermicro General Information

Driver Filename	iControl Version
Miranda_iTX_SuperMicro.js	6.6.x

Introduction

This driver supports Appliance 1 and Appliance 2, they are using the same MIBs but have different alarms.

Product Info

Supermicro are Industrial PC serving videos.

Driver Details

iTX Supermicro Driver Details

Driver Name	Driver Version	Device Firmware/Software Versions	MIBs	Original Project	Solutions Device Type
Miranda iTX Supermicro (Miranda_iTX_SuperMicro.js)	6.6.x		SUPERMICRO-SMI.mib SUPERMICRO-HEALTH-MIB.mib		

Parameters

iTX Supermicro Driver Parameters

Parameter	Description	Default Value	Configurable in GUI
pollInterval	Poller interval in seconds. Overwrite the default interval.	10	Yes
retries	If an SNMP request times out, this defines the number of retries to be performed.	2	Yes
timeout	Delay, in seconds, before declaring a timeout in the current SNMP request	5	Yes
uniqueID	An extra identifier to be assigned to the plugin that differentiates its alarms from the other plugin of the same type. The uniqueID must be part of uri.		No
readCommunity	SNMP read community string, used for SNMP polling.	public	Yes
writeCommunity	SNMP write community string, used to send SNMP-set commands.		Yes

Appliance 1 Device Tab

ID	ITX_PLAYOUT_5A
TYPE	ITX
ENABLE	YES
IP	145.58.105.106
ITX Domain	NPO
ITX Channel Name	TX-PLY-72209

Application Server	MAIN_APP_SERVER
Rack ID	R02B12
Rack Position	31
Friendly Name	BVN iTX Main

Alarms

Appliance 1 Alarms for ITX Device

Alarms for ITX Device Type Appliance 1

Alarm Uri	Alarm Name	Alarm Type	Level	alarmPanel
{baseuri}channelState	Channel State	BOTH	SERVICE	ALARMPANEL
{baseuri}currentClip/name	Name	TEXT	SERVICE	ALARMPANEL
{baseuri}currentClip/title	Title	TEXT	SERVICE	ALARMPANEL
{baseuri}currentClip/duration	Duration	TEXT	SERVICE	ALARMPANEL
{baseuri}currentClip/startTime	Start Time	TEXT	SERVICE	ALARMPANEL
{baseuri}currentClip/endTime	End Time	TEXT	SERVICE	ALARMPANEL
{baseuri}comingNext	Coming Text	TEXT	SERVICE	ALARMPANEL
{baseuri}nextTransition	Next Transition	TEXT	SERVICE	ALARMPANEL

Appliance 1 Fan Group Alarms for ITX Device

Alarm URI	Alarm Name	Alarm Type	Level	Alarm Panel
{hardwarebaseuri}communication	Network Connectivity	BOTH	SERVICE/DEVICE	ALARMPANEL
{hardwarebaseuri}Fan1FanSpeed	Fan Speed RPM Fan 1	BOTH	DEVICE	
{hardwarebaseuri}Fan2FanSpeed	Fan Speed RPM Fan 2	BOTH	DEVICE	
{hardwarebaseuri}Fan3FanSpeed	Fan Speed RPM Fan 3	BOTH	DEVICE	
{hardwarebaseuri}Fan4FanSpeed	Fan Speed RPM Fan 4	BOTH	DEVICE	

Appliance 1 Fan Group Alarms for ITX Device

Alarm URI	Alarm Name	Alarm Type	Level	Alarm Panel
{hardwarebaseuri}Fan5FanSpeed	Fan Speed RPM Fan 5	BOTH	DEVICE	
{hardwarebaseuri}Power1Fan1Speed	Power1 Fan 1 Speed RPM	BOTH	DEVICE	
{hardwarebaseuri}Power2Fan1Speed	Power2 Fan 1 Speed RPM	BOTH	DEVICE	

Appliance 1 Health Group Alarms for ITX Device

Alarm URI	Alarm Name	Alarm Type	Level	Alarm Panel
{hardwarebaseuri}ChassisIntrusion	Chassis Intrusion	STATUS	DEVICE	
{hardwarebaseuri}DIMMTemperature	DIMM Temperature	STATUS	DEVICE	
{hardwarebaseuri}Power1SupplyFailure	Power1 Supply Failure	STATUS	DEVICE	
{hardwarebaseuri}Power2SupplyFailure	Power2 Supply Failure	STATUS	DEVICE	
{hardwarebaseuri}PowerSupplyFailure	Power Supply Failure	STATUS	DEVICE	

Appliance 1 Temperature Group Alarms for ITX Device

Alarm URI	Alarm Name	Alarm Type	Level	Alarm Panel
{hardwarebaseuri}CPU1Temperature	CPU1 Temperature C	BOTH	DEVICE	
{hardwarebaseuri}CPU2Temperature	CPU2 Temperature C	BOTH	DEVICE	
{hardwarebaseuri}Power1Temperature	Power1 Temperature C	BOTH	DEVICE	
{hardwarebaseuri}Power2Temperature	Power2 Temperature C	BOTH	DEVICE	
{hardwarebaseuri}SystemTemperature	System Temperature C	BOTH	DEVICE	

Appliance 1 Voltage Group Alarms for ITX Device

Alarm URI	Alarm Name	Alarm Type	Level	Alarm Panel
{hardwarebaseuri}11VVoltage	+1.1V Voltage mV	BOTH	DEVICE	
{hardwarebaseuri}15VVoltage	+1.5V Voltage mV	BOTH	DEVICE	
{hardwarebaseuri}33VsbVoltage	+3.3Vsb Voltage mV	BOTH	DEVICE	
{hardwarebaseuri}33VVoltage	+3.3V Voltage mV	BOTH	DEVICE	

Appliance 1 Voltage Group Alarms for ITX Device

Alarm URI	Alarm Name	Alarm Type	Level	Alarm Panel
{hardwarebaseuri}5VSBVoltage	+5Vsb Voltage mV	BOTH	DEVICE	
{hardwarebaseuri}5VVoltage	+5V Voltage mV	BOTH	DEVICE	
{hardwarebaseuri}12VVoltage	+12V Voltage mV	BOTH	DEVICE	
{hardwarebaseuri}CPU1DIMMVoltage	CPU1 DIMM Voltage mV	BOTH	DEVICE	
{hardwarebaseuri}CPU1VcoreVoltage	CPU1 Vcore Voltage mV	BOTH	DEVICE	
{hardwarebaseuri}CPU2DIMMVoltage	CPU2 DIMM Voltage mV	BOTH	DEVICE	
{hardwarebaseuri}CPU2VcoreVoltage	CPU2 Vcore Voltage mV	BOTH	DEVICE	
{hardwarebaseuri}VBATVoltage	VBAT Voltage mV	BOTH	DEVICE	

Appliance 2 Alarms**Table listing all available alarms provided by the Appliance 2**

GSM Alarm Name	Description	Status Type	Text Type	Profile
{baseUri}{channelname}/channelState	Channel State	Yes	Yes	Appliance1/appliance2
{baseUri}{channelname}/currentClip/name	Name	No	Yes	Appliance1/appliance2
{baseUri}{channelname}/currentClip/title	Title	No	Yes	Appliance1/appliance2
{baseUri}{channelname}/currentClip/duration	Duration	No	Yes	Appliance1/appliance2
{baseUri}{channelname}/currentClip/startTime	Start Time	No	Yes	Appliance1/appliance2
{baseUri}{channelname}/currentClip/endTime	End Time	No	Yes	Appliance1/appliance2
{baseUri}{channelname}/comingNext	Coming Text	No	Yes	Appliance1/appliance2
{baseUri}{channelname}/nextTransition	Next Transition	No	Yes	Appliance1/appliance2
[that.buildHardwareBaseAlarmUri()]communication	Network Connectivity	Yes	Yes	Appliance1/appliance2
[that.buildHardwareBaseAlarmUri()]PS1ACInputCurrent	Power1 AC Input Current mA	Yes	Yes	Appliance2

Table listing all available alarms provided by the Appliance 2

GSM Alarm Name	Description	Status Type	Text Type	Profile
[that.buildHardwareBaseAlarmUri()]PS1DC12VOutputCurrent	Power1 DC 12V Output Current mA	Yes	Yes	Appliance2
[that.buildHardwareBaseAlarmUri()]PS2ACInputCurrent	Power2 AC Input Current mA	Yes	Yes	Appliance2
[that.buildHardwareBaseAlarmUri()]PS2DC12VOutputCurrent	Power2 DC 12V Output Current mA	Yes	Yes	Appliance2
[that.buildHardwareBaseAlarmUri()]FAN1	Fan Speed RPM Fan 1	Yes	Yes	Appliance2
[that.buildHardwareBaseAlarmUri()]FAN2	Fan Speed RPM Fan 2	Yes	Yes	Appliance2
[that.buildHardwareBaseAlarmUri()]FAN3	Fan Speed RPM Fan 3	Yes	Yes	Appliance2
[that.buildHardwareBaseAlarmUri()]FAN4	Fan Speed RPM Fan 4	Yes	Yes	Appliance2
[that.buildHardwareBaseAlarmUri()]FAN5	Fan Speed RPM Fan 5	Yes	Yes	Appliance2
[that.buildHardwareBaseAlarmUri()]FAN6	Fan Speed RPM Fan 6	Yes	Yes	Appliance2
[that.buildHardwareBaseAlarmUri()]FAN7	Fan Speed RPM Fan 7	Yes	Yes	Appliance2
[that.buildHardwareBaseAlarmUri()]FAN8	Fan Speed RPM Fan 8	Yes	Yes	Appliance2
[that.buildHardwareBaseAlarmUri()]FAN9	Fan Speed RPM Fan 9	Yes	Yes	Appliance2
[that.buildHardwareBaseAlarmUri()]PS1Fan1	Power1 Fan 1 Speed RPM	Yes	Yes	Appliance2
[that.buildHardwareBaseAlarmUri()]PS1Fan2	Power1 Fan 2 Speed RPM	Yes	Yes	Appliance2
[that.buildHardwareBaseAlarmUri()]PS2Fan1	Power2 Fan 1 Speed RPM	Yes	Yes	Appliance2
[that.buildHardwareBaseAlarmUri()]PS2Fan2	Power2 Fan 2 Speed RPM	Yes	Yes	Appliance2
[that.buildHardwareBaseAlarmUri()]ChassisIntru	Chassis Intrusion	Yes	No	Appliance2
[that.buildHardwareBaseAlarmUri()]PS1Status	Power1 Supply Failure	Yes	No	Appliance2

Table listing all available alarms provided by the Appliance 2

GSM Alarm Name	Description	Status Type	Text Type	Profile
[that.buildHardwareBaseAlarmUri()]PS2Status	Power2 Supply Failure	Yes	No	Appliance2
[that.buildHardwareBaseAlarmUri()]PS1ACInputPower	Power1 AC Input Power mW	Yes	Yes	Appliance2
[that.buildHardwareBaseAlarmUri()]PS1DC12VOutputPower	Power1 DC 12V Output Power mW	Yes	Yes	Appliance2
[that.buildHardwareBaseAlarmUri()]PS2ACInputPower	Power2 AC Input Power mW	Yes	Yes	Appliance2
[that.buildHardwareBaseAlarmUri()]PS2DC12VOutputPower	Power2 DC 12V Output Power mW	Yes	Yes	Appliance2
[that.buildHardwareBaseAlarmUri()]CPU1Temp	CPU1 Temperature C	Yes	Yes	Appliance2
[that.buildHardwareBaseAlarmUri()]CPU2Temp	CPU2 Temperature C	Yes	Yes	Appliance2
[that.buildHardwareBaseAlarmUri()]MB10GTemp1	MB 10G Temperature 1 C	Yes	Yes	Appliance2
[that.buildHardwareBaseAlarmUri()]MB10GTemp2	MB 10G Temperature 2 C	Yes	Yes	Appliance2
[that.buildHardwareBaseAlarmUri()]P1DIMMA1Temp	P1 DIMM A 1 Temperature C	Yes	Yes	Appliance2
[that.buildHardwareBaseAlarmUri()]P1DIMMA2Temp	P1 DIMM A 2 Temperature C	Yes	Yes	Appliance2
[that.buildHardwareBaseAlarmUri()]P1DIMMA3Temp	P1 DIMM A 3 Temperature C	Yes	Yes	Appliance2
[that.buildHardwareBaseAlarmUri()]P1DIMMB1Temp	P1 DIMM B 1 Temperature C	Yes	Yes	Appliance2
[that.buildHardwareBaseAlarmUri()]P1DIMMB2Temp	P1 DIMM B 2 Temperature C	Yes	Yes	Appliance2
[that.buildHardwareBaseAlarmUri()]P1DIMMB3Temp	P1 DIMM B 3 Temperature C	Yes	Yes	Appliance2
[that.buildHardwareBaseAlarmUri()]P1DIMMC1Temp	P1 DIMM C 1 Temperature C	Yes	Yes	Appliance2
[that.buildHardwareBaseAlarmUri()]P1DIMMC2Temp	P1 DIMM C 2 Temperature C	Yes	Yes	Appliance2
[that.buildHardwareBaseAlarmUri()]P1DIMMC3Temp	P1 DIMM C 3 Temperature C	Yes	Yes	Appliance2

Table listing all available alarms provided by the Appliance 2

GSM Alarm Name	Description	Status Type	Text Type	Profile
[that.buildHardwareBaseAlarmUri()]P1DIMMD1Temp	P1 DIMM D 1 Temperature C	Yes	Yes	Appliance2
[that.buildHardwareBaseAlarmUri()]P1DIMMD2Temp	P1 DIMM D 2 Temperature C	Yes	Yes	Appliance2
[that.buildHardwareBaseAlarmUri()]P1DIMMD3Temp	P1 DIMM D 3 Temperature C	Yes	Yes	Appliance2
[that.buildHardwareBaseAlarmUri()]P2DIMME1Temp	P2 DIMM E 1 Temperature C	Yes	Yes	Appliance2
[that.buildHardwareBaseAlarmUri()]P2DIMME2Temp	P2 DIMM E 2 Temperature C	Yes	Yes	Appliance2
[that.buildHardwareBaseAlarmUri()]P2DIMME3Temp	P2 DIMM E 3 Temperature C	Yes	Yes	Appliance2
[that.buildHardwareBaseAlarmUri()]P2DIMMF1Temp	P2 DIMM F 1 Temperature C	Yes	Yes	Appliance2
[that.buildHardwareBaseAlarmUri()]P2DIMMF2Temp	P2 DIMM F 2 Temperature C	Yes	Yes	Appliance2
[that.buildHardwareBaseAlarmUri()]P2DIMMF3Temp	P2 DIMM F 3 Temperature C	Yes	Yes	Appliance2
[that.buildHardwareBaseAlarmUri()]P2DIMMG1Temp	P2 DIMM G 1 Temperature C	Yes	Yes	Appliance2
[that.buildHardwareBaseAlarmUri()]P2DIMMG2Temp	P2 DIMM G 2 Temperature C	Yes	Yes	Appliance2
[that.buildHardwareBaseAlarmUri()]P2DIMMG3Temp	P2 DIMM G 3 Temperature C	Yes	Yes	Appliance2
[that.buildHardwareBaseAlarmUri()]P2DIMMH1Temp	P2 DIMM H 1 Temperature C	Yes	Yes	Appliance2
[that.buildHardwareBaseAlarmUri()]P2DIMMH2Temp	P2 DIMM H 2 Temperature C	Yes	Yes	Appliance2
[that.buildHardwareBaseAlarmUri()]P2DIMMH3Temp	P2 DIMM H 3 Temperature C	Yes	Yes	Appliance2
[that.buildHardwareBaseAlarmUri()]PCHTemp	PCH Temperature C	Yes	Yes	Appliance2
[that.buildHardwareBaseAlarmUri()]PeripheralTemp	Peripheral Temperature C	Yes	Yes	Appliance2
[that.buildHardwareBaseAlarmUri()]PS1Temperature1	Power1 Temperature 1 C	Yes	Yes	Appliance2

Table listing all available alarms provided by the Appliance 2

GSM Alarm Name	Description	Status Type	Text Type	Profile
[that.buildHardwareBaseAlarmUri()]PS1Temperature2	Power1 Temperature 2 C	Yes	Yes	Appliance2
[that.buildHardwareBaseAlarmUri()]PS2Temperature1	Power2 Temperature 1 C	Yes	Yes	Appliance2
[that.buildHardwareBaseAlarmUri()]PS2Temperature2	Power2 Temperature 2 C	Yes	Yes	Appliance2
[that.buildHardwareBaseAlarmUri()]SystemTemp	System Temperature C	Yes	Yes	Appliance2
[that.buildHardwareBaseAlarmUri()]Vcpu1VRMTemp	CPU1 VRM Temperature C	Yes	Yes	Appliance2
[that.buildHardwareBaseAlarmUri()]Vcpu2VRMTemp	CPU2 VRM Temperature C	Yes	Yes	Appliance2
[that.buildHardwareBaseAlarmUri()]VmemABVRMTemp	DIMM AB VRM Temperature C	Yes	Yes	Appliance2
[that.buildHardwareBaseAlarmUri()]VmemCDVRMTemp	DIMM CD VRM Temperature C	Yes	Yes	Appliance2
[that.buildHardwareBaseAlarmUri()]VmemEFVRMTemp	DIMM EF VRM Temperature C	Yes	Yes	Appliance2
[that.buildHardwareBaseAlarmUri()]VmemGHVRMTemp	DIMM GH VRM Temperature C	Yes	Yes	Appliance2
[that.buildHardwareBaseAlarmUri()]12VBMC	+1.2V BMC Voltage mV	Yes	Yes	Appliance2
[that.buildHardwareBaseAlarmUri()]105VPCH	+1.05V PCH Voltage mV	Yes	Yes	Appliance2
[that.buildHardwareBaseAlarmUri()]15VPCH	+1.5V PCH Voltage mV	Yes	Yes	Appliance2
[that.buildHardwareBaseAlarmUri()]33VCC	+3.3Vcc Voltage mV	Yes	Yes	Appliance2
[that.buildHardwareBaseAlarmUri()]33VSB	+3.3Vsb Voltage mV	Yes	Yes	Appliance2
[that.buildHardwareBaseAlarmUri()]5VCC	+5Vcc Voltage mV	Yes	Yes	Appliance2
[that.buildHardwareBaseAlarmUri()]5VSB	+5Vsb Voltage mV	Yes	Yes	Appliance2
[that.buildHardwareBaseAlarmUri()]12V	+12V Voltage mV	Yes	Yes	Appliance2

Table listing all available alarms provided by the Appliance 2

GSM Alarm Name	Description	Status Type	Text Type	Profile
[that.buildHardwareBaseAlarmUri() ()PS1ACInputVoltage	Power1 AC Input Voltage mV	Yes	Yes	Appliance2
[that.buildHardwareBaseAlarmUri() ()PS1DC12VOutputVoltage	Power1 DC 12V Output Voltage mV	Yes	Yes	Appliance2
[that.buildHardwareBaseAlarmUri() ()PS2ACInputVoltage	Power2 AC Input Voltage mV	Yes	Yes	Appliance2
[that.buildHardwareBaseAlarmUri() ()PS2DC12VOutputVoltage	Power2 DC 12V Output Voltage mV	Yes	Yes	Appliance2
[that.buildHardwareBaseAlarmUri() ()VBAT	VBAT Voltage mV	Yes	Yes	Appliance2
[that.buildHardwareBaseAlarmUri() ()Vcpu1	CPU1 Voltage mV	Yes	Yes	Appliance2
[that.buildHardwareBaseAlarmUri() ()Vcpu2	CPU2 Voltage mV	Yes	Yes	Appliance2
[that.buildHardwareBaseAlarmUri() ()VDIMMAB	DIMM AB Voltage mV	Yes	Yes	Appliance2
[that.buildHardwareBaseAlarmUri() ()VDIMMCD	DIMM CD Voltage mV	Yes	Yes	Appliance2
[that.buildHardwareBaseAlarmUri() ()VDIMMEF	DIMM EF Voltage mV	Yes	Yes	Appliance2
[that.buildHardwareBaseAlarmUri() ()VDIMMGH	DIMM GH Voltage mV	Yes	Yes	Appliance2

K2 Edge



K2 Edge is a robust and proven Linux-based, software-centric, multi-platform playout system with a purpose-built, high availability architecture for mission-critical 24/7 playout applications.

There are currently two versions of the driver:

- a version—named `GrassValley_K2_Edge_v1.js`—which was originally built (under a different name) to service the legacy K2 Edge using firmware version 4.1, and
- a newer version—named `GrassValley_K2_Edge_v2.js`—which has most recently been reviewed by Grass Valley and which uses firmware version 4.2

Note: The differences between `GrassValley_K2_Edge_v1.js` and `GrassValley_K2_Edge_v2.js` are as follows:

- All OIDs are different, starting by the enterprise code changed.
 - Driver v1 has memory alarms that v2 does not have.
 - Driver v2 has PSU1 and PSU2 alarms that v1 does not have.
 - Hard Disk Smart Status and Hard Disk Status text is different in GSM alarm.
 - Number of fans and hard drives are different.
-

See the following for device support details:

Summary

[K2 Edge alarms \(driver `GrassValley_K2_Edge_v1.js`\), on page 105](#)

[K2 Edge alarms \(driver `GrassValley_K2_Edge_v2.js`\), on page 106](#)

[K2 Edge Configurable parameters, on page 108](#)

[K2 Edge Alarm parameters in iC Web, on page 109](#)

[K2 Edge Alarm parameters in iC Web, on page 109](#)

[K2 Edge MIBs Used, on page 109](#)

K2 Edge alarms (driver `GrassValley_K2_Edge_v1.js`)

Alarm name	Type	Polling or trap?	URI format
Communication Status	Status	Indicates communication status with the device	{baseuri}commStatus
Power	Status	Indicates reboot status of the device	{baseuri}powerCycle
Fan RPM (1 per Fan)	Both	Total amount of memory available	{baseuri}hrMemorySize
Hard Disk Smart Status (1 per HD)	Both	Model of the device	{baseuri}gvgElModel
Hard Disk Status (1 per HD)	Both	Operational state of the device	{baseuri}gvgElState
Hard Disk Temp (1 per HD)	Both	Software revision of the firmware on the device	{baseuri}gvgElSoftwareRev
Load 1 Min.	Both	Informative string pertaining the logical disk	{baseuri}LogicalDisk{diskId}/hrStorageDescr
Load 5 Min.	Both	Total space available on the logical disk (bytes)	{baseuri}LogicalDisk{diskId}/hrStorageSize

K2 Edge alarms (driver GrassValley_K2_Edge_v1.js) (continued)

Alarm name	Type	Polling or trap?	URI format
Load 10 Min.	Both	Amount of space used on the logical disk (bytes)	{baseuri}LogicalDisk{diskId}/hrStorageUsed
Partition Free Space (1 per partition)	Both	Initialization status of the disk recorder	{baseuri}DiskRecorder{diskRecId}/drsAsBootState
Temperature	Both	Operational status of disk recorder chassis cooling fans	{baseuri}DiskRecorder{diskRecId}/drsAsFans
Temperature Sensor Description	Both	Power supply redundancy state of the disk recorder	{baseuri}DiskRecorder{diskRecId}/drsAsRedundantPower
Warning Text (per warning index)	Both	Operational status of the internal disk recorder repository	{baseuri}DiskRecorder{diskRecId}/drsAsRepositoryState
Dead Programs	Both	Generalized state of the disk recorder's media storage system	{baseuri}DiskRecorder{diskRecId}/drsAsStorageState
Memory Free	Both	Disk recorder chassis internal temperature in degrees	{baseuri}DiskRecorder{diskRecId}/drsAsTemperature
Memory Total	Both	Thermal operating condition of the disk recorder	{baseuri}DiskRecorder{diskRecId}/drsAsThermal

K2 Edge alarms (driver GrassValley_K2_Edge_v2.js)

Alarm name	Per	Description	URI format
Communication Status	Device	Indicates communication status with the device	{baseuri}commStatus
Device Reboot	Device	Indicates reboot status of the device	{baseuri}powerCycle
Total Memory	Device	Total amount of memory available	{baseuri}hrMemorySize
Device Model	Device	Model of the device	{baseuri}vgvElModel
Operational State	Device	Operational state of the device	{baseuri}vgvElState
Software Revision	Device	Software revision of the firmware on the device	{baseuri}vgvElSoftwareRev
Description	Device Logical Disk	Informative string pertaining the logical disk	{baseuri}LogicalDisk{diskId}/hrStorageDescr

K2 Edge alarms (driver GrassValley_K2_Edge_v2.js) (continued)

Alarm name	Per	Description	URI format
Size	Device Logical Disk	Total space available on the logical disk (bytes)	{baseuri}LogicalDisk{diskId}/hrStorageSize
Used	Device Logical Disk	Amount of space used on the logical disk (bytes)	{baseuri}LogicalDisk{diskId}/hrStorageUsed
Boot State	Disk Recorder	Initialization status of the disk recorder	{baseuri}DiskRecorder{diskRecId}/drsAsBootState
Fans Status	Disk Recorder	Operational status of disk recorder chassis cooling fans	{baseuri}DiskRecorder{diskRecId}/drsAsFans
Redundant Power	Disk Recorder	Power supply redundancy state of the disk recorder	{baseuri}DiskRecorder{diskRecId}/drsAsRedundantPower
Repository State	Disk Recorder	Operational status of the internal disk recorder repository	{baseuri}DiskRecorder{diskRecId}/drsAsRepositoryState
Storage State	Disk Recorder	Generalized state of the disk recorder's media storage system	{baseuri}DiskRecorder{diskRecId}/drsAsStorageState
Temperature	Disk Recorder	Disk recorder chassis internal temperature in degrees	{baseuri}DiskRecorder{diskRecId}/drsAsTemperature
Thermal Status	Disk Recorder	Thermal operating condition of the disk recorder	{baseuri}DiskRecorder{diskRecId}/drsAsThermal
Video State	Disk Recorder	Video frame reference status of the disk recorder	{baseuri}DiskRecorder{diskRecId}/drsAsVideoReference
Audio Date State	Disk Recorder Channel	Health of audio data handled by the channel	{baseuri}DiskRecorder{diskRecId}/Channel{channelId}/drsCsAuState
Operational State	Disk Recorder Channel	Channel operational state	{baseuri}DiskRecorder{diskRecId}/Channel{channelId}/drsCsOpState
Video Data State	Disk Recorder Channel	Health of video data handled by the channel	{baseuri}DiskRecorder{diskRecId}/Channel{channelId}/drsCsViState

K2 Edge alarms (driver GrassValley_K2_Edge_v2.js) (continued)

Alarm name	Per	Description	URI format
Status	Disk Recorder Clip Inventory	Status of clip inventory	{baseuri}DiskRecorder{diskRecId}/ClipInventory{clipInvId}/drsInvStatus
Status	Disk Recorder File System	Status of file system	{baseuri}DiskRecorder{diskRecId}/FileSystem{fileSysId}/drsFsStatus

K2 Edge Configurable parameters

Parameter name	Parameter object key	Description	Default value
Poll Interval	pollInterval	Poller interval in seconds. Overwrite the default interval.	30 seconds
Retries	retries	If an SNMP request times out, this defines the number of retries to be performed.	1 retry
Timeout	timeout	Delay in seconds before declaring a timeout in the current SNMP request.	3 seconds
Read Community	readCommunity	SNMP read community string, used for SNMP polling.	"public"
Temperature threshold	tempThreshold	Threshold for GPU temperature alarm.	70
Hard drive temperature threshold	hdTempThreshold	Threshold for hard drive temperature alarms.	60
Memory threshold	memThreshold	Threshold before setting a memory alarm	2e20
Fan RPM threshold	fanRPMThreshold	Threshold before setting a Fan RPM alarm	0
Free space threshold	freeSpaceThreshold	Threshold before setting a HD space alarm	0
Load threshold	loadThreshold	Threshold before setting a load alarm	150
Throttling delay	throttlingDelay	Delay in milli seconds between each SNMP request	200

K2 Edge Alarm parameters in iC Web

Parameter	Description
diskRecId	Disk Recorder ID (many per Device)
diskId	Logical Disk ID (many per Device)
channelId	Channel ID (many per Disk Recorder)
clipInvlId	Clip Inventory ID (many per Disk Recorder)
fileSysId	File System ID (many per Disk Recorder)

K2 Edge MIBs Used

MIB	MIB File Name
Host Resources MIB	HOST-RESOURCES-MIB.mib
Grass Valley Generic Physical Element MIB	GVG-ELEMENT-MIB.mib
Grass Valley Disk Recorder Status MIB	GVG-DRS-MIB.mib
Grass Valley Transfer Control and Monitoring MIB	GVG-TCM-MIB.mib

Base URI for alarms

Assuming an Application Server's hostname is *AppServer1*, and the IP address of the K2 Summit device is 10.12.170.141:

```
snmp://AppServer1:K2_Summit:10.12.170.140/
```

Kaleido-Alto/Quad

High-resolution Kaleido-Alto/Quad multi-image display processors.

Kaleido-K2

High-resolution Kaleido-K2: multi-image display processor.

Grass Valley K2 SAN**Introduction**

GV K2 are media servers, storage, and integrated playout devices. They bring benefits of mainstream computer industries to broadcast enterprise, including the latest advances in processing power and storage capacity with ease of integration, and streamlined operation

and management, for formats ranging from SD to 4K. More information is available in this link ([K2 servers](#)).

As part of their functionality, they provide the ability to store media in an external location, which always is a NEC M100 device. The **GV K2 SAN** driver is designed to monitor and report alarms for this type of device.

Summary

[Grass Valley K2 SAN Configurable Driver Parameters](#), on page 110

[Grass Valley K2 SAN Driver Information](#), on page 110

[K2 Solo Media Server Configurable Parameters](#), on page 117

[K2 Solo Media Server Alarm Parameters in iC Web](#), on page 117

[K2 Solo Media Server MIBs Used](#), on page 118

Required MIB Files

Grass Valley K2 SAN Driver Information

Name	MIB File
ARMGMT-MIB	M100.mib

Configurable Driver Parameters

Grass Valley K2 SAN Configurable Driver Parameters

Name	Variable Name	Description	Default Value
Poll Interval	<code>pollInterval</code>	Period between SNMP polls to the device	30 seconds
Retries	<code>retries</code>	Number of retries after a failed SNMP poll	1 retry
Timeout	<code>timeout</code>	Number of seconds to wait for a response before declaring the SNMP poll as failed	5 seconds
Read Community	<code>readCommunity</code>	SNMP read community string (password).	"public"

Alarms

The following image presents the alarms with the current version of the driver.

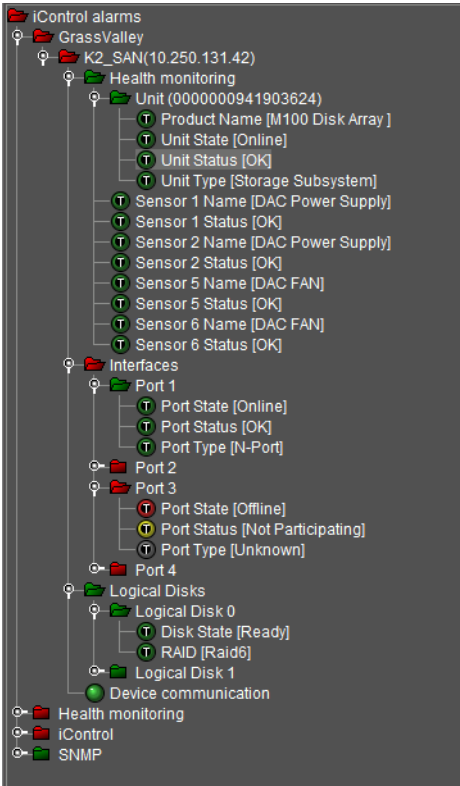

Grass Valley K2 SAN Alarm Parameters

GSM Alarm Name	Type	Poll/ Trap	Description	URI	MIB Node Name	OID
Disk State	Both	Poll	Logical Disk (LUN) status: Ready, Reduce, Rebuild, Preventive Copy, or Copy Back. Expected status: Ready state	baseUri/	arBindLDNState	.1.3.6.1.4.1.119.1.68.1.1.14.1.1.4
Port State	Both	Poll	Hardware Port State: Unknown, Online, Offline, or Bypassed	baseUri/Port<port number>/arUnitPortState	arUnitPortState	.1.3.6.1.4.1.119.1.68.1.1.10.1.6
Port Status	Both	Poll	Port protocol status: Unknown, Unused, OK, Warning, Failure, Not Participating, Initializing, or Bypass	baseUri/Port<port number>/arUnitPortStatus	arUnitPortStatus	.1.3.6.1.4.1.119.1.68.1.1.10.1.7

Grass Valley K2 SAN Alarm Parameters

GSM Alarm Name	Type	Poll/Trap	Description	URI	MIB Node Name	OID
Port Type	Both	Poll	Port type	baseUri/Port<port number>/arUnitPortType	arUnitPortType	.1.3.6.1.4.1.119.1.68.1.1.10.1.3
Product Name	Text	Poll	Connectivity unit: Vendor's product model name	baseUri/Unit(<unitId>)/arUnitProduct	arUnitProduct	.1.3.6.1.4.1.119.1.68.1.1.6.1.20
RAID	Text	Poll	Logical disk raid kind	baseUri/	arBindLDNKindOfRAID	.1.3.6.1.4.1.119.1.68.1.1.14.1.1.9
Sensor <Num> Name	Text	Poll	DAC* sensor status, e.g. DAC power supplies and fans Note: First polling call takes time, as all the alarms must be built.	baseUri/Sensor<sensor number>/arUnitSensorName	arUnitSensorName	.1.3.6.1.4.1.119.1.68.1.1.8.1.3
Sensor <Num> Status	Both	Poll	Sensor status: Unknown, Other, OK, Warning, or Failed.	baseUri/Sensor<sensor number>/arUnitSensorType	arUnitSensorType	.1.3.6.1.4.1.119.1.68.1.1.8.1.4
Unit State	Both	Poll	Connectivity unit state: Unknown, Online, or Offline.	baseUri/Unit(<unitId>)/arUnitState	arUnitState	.1.3.6.1.4.1.119.1.68.1.1.6.1.5
Unit Status	Both	Poll	Connectivity unit status: Unknown, Unused, Ok, Warning, or Failed.	baseUri/Unit(<unitId>)/arUnitStatus	arUnitStatus	.1.3.6.1.4.1.119.1.68.1.1.6.1.6
Unit Type	Text	Poll	Connectivity unit type: Expected: Storage Subsystem	baseUri/Unit(<unitId>)/arUnitType	arUnitType	.1.3.6.1.4.1.119.1.68.1.1.6.1.3

*DAC stands for Disk Array Controller; it represents the SAN controller device.

Base URI: snmp://K2_SAN:<host>

Test Device

Test Device parameters

IP Address	Description
10.37.49.190	Emulated device
10.250.131.42	Real device

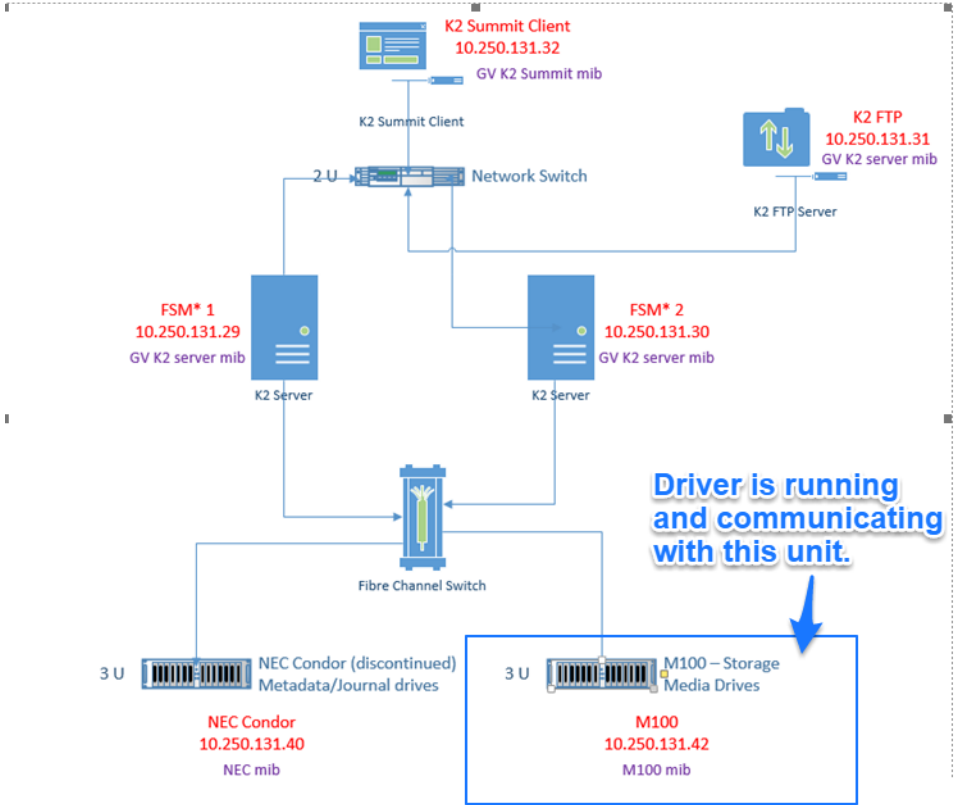

K2 Solo Media Server



The Grass Valley K2 Solo is a media server. Broadcast-capable and optimized for both production and broadcast workflows, K2 Solo delivers all the same functionality as a two-channel K2 Summit 3G Production Client, but takes up 50% less space — ideal for small production studios and mobile production trucks. This high-quality HD/SD media server comes with 25 hours of HD storage and is also compatible with all applications that run on the K2 Summit 3G Production Client.

Summary

[K2 Solo Media Server Alarms](#), on page 114

[K2 Solo Media Server Configurable Parameters](#), on page 117

[K2 Solo Media Server Alarm Parameters in iC Web](#), on page 117

[K2 Solo Media Server MIBs Used](#), on page 118

K2 Solo Media Server Alarms

Alarm name	Group	Per	Description	URI format
Used	Storage	Device Logical Disk	Amount of space used on the logical disk (bytes)	{baseuri}LogicalDisk{diskId}/hrStorageUsed
Management SW Build	Info	Device	Build number of the management software	{baseuri}systemManagementSoftwareBuildNumber
Global System Status	Chassis	Chassis	Global system status of the chassis	{baseuri}Chassis{chassisId}/systemStateGlobalSystemStatus
Management SW Global Version	Info	Device	Global version of the management software	{baseuri}systemManagementSoftwareGlobalVersionName
Communication Status	~	Device	Indicates communication status with the device	{baseuri}commStatus

K2 Solo Media Server Alarms (continued)

Alarm name	Group	Per	Description	URI format
Device Reboot	~	Device	Indicates reboot status of the device	{baseuri}powerCycle
Description	Storage	Device Logical Disk	Informative string pertaining the logical disk	{baseuri}LogicalDisk{diskId}/hrStorageDescr
Chassis Intrusion Status	Chassis	Chassis	Intrusion reading of all intrusion detection devices in the chassis	{baseuri}Chassis{chassisId}/systemStateChassisIntrusionStatusCombined
MIB Version Major	Info	Device	Major number of the MIB version (In this case, the version is 5.9)	{baseuri}mIBMajorVersionNumber
Allocated Memory	Storage Bridge	Device	Memory currently allocated for forward storage requests (kB)	{baseuri}sbsBrAllocatedMem
MIB Version Minor	Info	Device	Minor number of the MIB version (in this case, the version is 5.9)	{baseuri}mIBMinorVersionNumber
Device Model	Info	Device	Model of the device	{baseuri}gvgElModel
Management SW Name	Info	Device	Name of the management software	{baseuri}systemManagementSoftwareName
Operational State	Info	Device	Operational state of the device	{baseuri}gvgElState
Status	Storage Bridge	Device	Operational status of the storage bridge	{baseuri}sbsBrStatus
Software Revision	Info	Device	Software revision of the firmware on the device	{baseuri}gvgElSoftwareRev
Chassis State	Chassis	Chassis	State of the chassis	{baseuri}Chassis{chassisId}/systemStateChassisState
Amperage Status	Chassis	Chassis	Status of all amperage probes in the chassis	{baseuri}Chassis{chassisId}/systemStateAmperageStatusCombined
Cooling Device Status	Chassis	Chassis	Status of all cooling devices in the chassis	{baseuri}Chassis{chassisId}/systemStateCoolingDeviceStatusCombined
Memory Device Status	Chassis	Chassis	Status of all memory devices in the chassis	{baseuri}Chassis{chassisId}/systemStateMemoryDeviceStatusCombined
Power Supply Status	Chassis	Chassis	Status of all power supplies in the chassis	{baseuri}Chassis{chassisId}/systemStatePowerSupplyStatusCombined

K2 Solo Media Server Alarms (continued)

Alarm name	Group	Per	Description	URI format
Temperature Status	Chassis	Chassis	Status of all temperature probes in the chassis	{baseuri}Chassis{chassisId}/systemStateTemperatureStatusCombined
Power Units Status	Chassis	Chassis	Status of all the power unit(s) in the chassis	{baseuri}Chassis{chassisId}/systemStatePowerUnitStatusRedundancy
Voltage Status	Chassis	Chassis	Status of all voltage probes in the chassis	{baseuri}Chassis{chassisId}/systemStateVoltageStatusCombined
Base Board Status	Base Boards	Base Board	Status of the base board	{baseuri}Chassis{chassisId}/BaseBoard{baseboardId}/baseBoardStatus
Firmware Status	Firmwares	Firmware	Status of the firmware	{baseuri}Chassis{chassisId}/Firmware{firmwareId}/firmwareStatus
OS Status	Chassis	Chassis	Status of the operating system	{baseuri}Chassis{chassisId}/operatingSystemStatus
OS Memory Status	Chassis	Chassis	Status of the operating system memory	{baseuri}Chassis{chassisId}/operatingSystemMemoryStatus
System BIOS Status	BIOS	BIOS	Status of the system BIOS	{baseuri}Chassis{chassisId}/BIOS{biosId}/systemBIOSStatus
Chassis Status	Chassis	Chassis	System status of the chassis	{baseuri}Chassis{chassisId}/systemStateChassisStatus
Cooling Units Status	Chassis	Chassis	System status of the cooling units in the chassis	{baseuri}Chassis{chassisId}/systemStateCoolingUnitStatusRedundancy
Total Memory	Memory	Device	Total amount of memory available	{baseuri}hrMemorySize
Reserved Memory	Storage Bridge	Device	Total memory that the bridge has reserved for forward storage requests (kB)	{baseuri}sbsBrReservedMem
Size	Storage	Device Logical Disk	Total space available on the logical disk (bytes)	{baseuri}LogicalDisk{diskId}/hrStorageSize

K2 Solo Media Server Alarms (continued)

Alarm name	Group	Per	Description	URI format
Version	Storage Bridge	Device	Version descriptor for the storage bridge	{baseuri}sbsBrVersion
Management SW Version	Info	Device	Version of the management software	{baseuri}systemManagementSoftwareVersionNumberName

K2 Solo Media Server Configurable Parameters

Parameter Name	Parameter Object Key	Description	Default Value
Alarm Path	alarmPath	Path under which alarms are created in IC Nav	"GrassValley/K2_Media_Server (<IP>)"
Poll Interval	pollInterval	Period between repeated SNMP polls to the device	30 seconds
Retries	retries	Number of times to retry after a failed SNMP poll	1 retry
Timeout	timeout	Number of seconds to wait for a response before declaring SNMP poll failed	3 seconds
Read Community	readCommunity	SNMP read community string (password)	"public"
Storage Used Percentage Critical Threshold	hrStorageCriticalPercent	If the storage used exceeds this percentage, flag the storage used alarm to <code>CRITICAL</code>	0.9
Storage Used Percentage Warning Threshold	hrStorageWarningPercent	If the storage used exceeds this percentage, flag the storage used alarm to <code>WARNING</code>	0.8

K2 Solo Media Server Alarm Parameters in iC Web

Parameter	Description
chassisId	Chassis ID (many per Device)
diskId	Logical Disk ID (many per Device)
baseBoardId	Base Board ID (many per Chassis)
biosId	BIOS ID (many per Chassis)
firmwareId	Firmware ID (many per Chassis)

K2 Solo Media Server MIBs Used

MIB	MIB file name
Host Resources MIB	HOST-RESOURCES-MIB.mib
Dell 10892 MIB	MIB-Dell-10892.mib
Grass Valley Generic Physical Element MIB	GVG-ELEMENT-MIB.mib
Grass Valley SAN Storage Server MIB	GVG-SSR-MIB.mib
Grass Valley Storage Bridge Status MIB ^a	GVG-SBS-MIB.mib

a.A *Storage Bridge* is a combination of logical and/or physical entities that work in conjunction to essentially store and forward media storage control and IO requests between a set of dissimilar storage client and a set of storage provider architectures.

Base URI for alarms

Assuming an Application Server's hostname is *AppServer1*, and the IP address of the K2 Solo Media Server device is 10.12.170.140:

```
snmp://AppServer1:K2_Media_Server:10.12.170.140/
```

K2 Summit Production Client



The Grass Valley K2 Summit is a transmission server. The K2 Summit 3G Production Client is optimized for a broad range of production and broadcast applications and is the only server that supports end-to-end SD/HD workflows in DVCPRO, MPEG-2, AVC-Intra and H.264/AVCHD formats. With bidirectional channel control, you can quickly switch between record and play. Individual channels can be software configured for additional functions as well as the creation of low-resolution streams and proxy, making the the K2 Summit 3G Production Client the most versatile server available.

Summary

[K2 Summit Alarms](#), on page 119

[K2 Summit Configurable Parameters, on page 120](#)

[K2 Summit Alarm parameters in iC Web, on page 121](#)

[K2 Summit MIBs used, on page 121](#)

K2 Summit Alarms

Alarm name	Per	Description	URI format
Communication Status	Device	Indicates communication status with the device	{baseuri}commStatus
Device Reboot	Device	Indicates reboot status of the device	{baseuri}powerCycle
Total Memory	Device	Total amount of memory available	{baseuri}hrMemorySize
Device Model	Device	Model of the device	{baseuri}gvgElModel
Operational State	Device	Operational state of the device	{baseuri}gvgElState
Software Revision	Device	Software revision of the firmware on the device	{baseuri}gvgElSoftwareRev
Description	Device Logical Disk	Informative string pertaining the logical disk	{baseuri}LogicalDisk{diskId}/hrStorageDescr
Size	Device Logical Disk	Total space available on the logical disk (bytes)	{baseuri}LogicalDisk{diskId}/hrStorageSize
Used	Device Logical Disk	Amount of space used on the logical disk (bytes)	{baseuri}LogicalDisk{diskId}/hrStorageUsed
Boot State	Disk Recorder	Initialization status of the disk recorder	{baseuri}DiskRecorder{diskRecId}/drsAsBootState
Fans Status	Disk Recorder	Operational status of disk recorder chassis cooling fans	{baseuri}DiskRecorder{diskRecId}/drsAsFans
Redundant Power	Disk Recorder	Power supply redundancy state of the disk recorder	{baseuri}DiskRecorder{diskRecId}/drsAsRedundantPower
Repository State	Disk Recorder	Operational status of the internal disk recorder repository	{baseuri}DiskRecorder{diskRecId}/drsAsRepositoryState
Storage State	Disk Recorder	Generalized state of the disk recorder's media storage system	{baseuri}DiskRecorder{diskRecId}/drsAsStorageState
Temperature	Disk Recorder	Disk recorder chassis internal temperature in degrees	{baseuri}DiskRecorder{diskRecId}/drsAsTemperature
Thermal Status	Disk Recorder	Thermal operating condition of the disk recorder	{baseuri}DiskRecorder{diskRecId}/drsAsThermal

K2 Summit Alarms (continued)

Alarm name	Per	Description	URI format
Video State	Disk Recorder	Video frame reference status of the disk recorder	{baseuri}DiskRecorder{diskRecId}/drsAsVideoReference
Audio Date State	Disk Recorder Channel	Health of audio data handled by the channel	{baseuri}DiskRecorder{diskRecId}/Channel{channelId}/drsCsAuState
Operational State	Disk Recorder Channel	Channel operational state	{baseuri}DiskRecorder{diskRecId}/Channel{channelId}/drsCsOpState
Video Data State	Disk Recorder Channel	Health of video data handled by the channel	{baseuri}DiskRecorder{diskRecId}/Channel{channelId}/drsCsViState
Status	Disk Recorder Clip Inventory	Status of clip inventory	{baseuri}DiskRecorder{diskRecId}/ClipInventory{clipInvId}/drsInvStatus
Status	Disk Recorder File System	Status of file system	{baseuri}DiskRecorder{diskRecId}/FileSystem{fileSysId}/drsFsStatus

K2 Summit Configurable Parameters

Parameter name	Parameter object key	Description	Default value
Alarm Path	alarmPath	Path under which alarms are created in IC Nav	"GrassValley/K2_Summit(<IP>)"
Poll Interval	pollInterval	Period between repeated SNMP polls to the device	30 seconds
Retries	retries	Number of times to retry after a failed SNMP poll	1 retry
Timeout	timeout	Number of seconds to wait for a response before declaring SNMP poll failed	3 seconds
Read Community	readCommunity	SNMP read community string (password)	"public"

K2 Summit Configurable Parameters (continued)

Parameter name	Parameter object key	Description	Default value
Storage Used Percentage Critical Threshold	hrStorageCriticalPercent	If the storage used exceeds this percentage, flag the storage used alarm to <code>CRITICAL</code>	0.9
Storage Used Percentage Warning Threshold	hrStorageWarningPercent	If the storage used exceeds this percentage, flag the storage used alarm to <code>WARNING</code>	0.8

K2 Summit Alarm parameters in iC Web

Parameter	Description
diskRecId	Disk Recorder ID (many per Device)
diskId	Logical Disk ID (many per Device)
channelId	Channel ID (many per Disk Recorder)
clipInvlId	Clip Inventory ID (many per Disk Recorder)
fileSysId	File System ID (many per Disk Recorder)

K2 Summit MIBs used

MIB	MIB file name
Host Resources MIB	HOST-RESOURCES-MIB.mib
Grass Valley Generic Physical Element MIB	GVG-ELEMENT-MIB.mib
Grass Valley Disk Recorder Status MIB	GVG-DRS-MIB.mib
Grass Valley Transfer Control and Monitoring MIB	GVG-TCM-MIB.mib

Base URI for alarms

Assuming an Application Server's hostname is *AppServer1*, and the IP address of the K2 Summit device is 10.12.170.141:
 snmp://AppServer1:K2_Summit:10.12.170.140/

Kaleido-X

High-resolution Kaleido-X multi-image display processor.

Grass Valley NV9000 System Controller

The following shows a view of the alarms reported in iControl GSM after having instantiated the SNMP - nVision NV9000 driver:

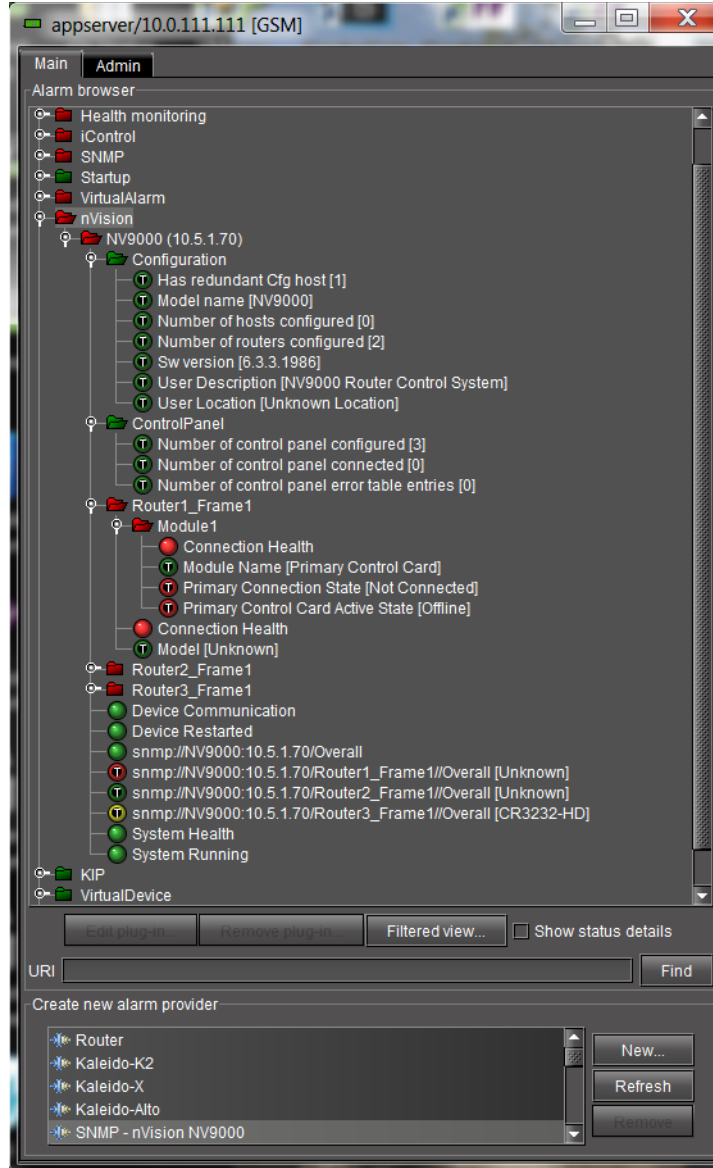

Parameters

The SNMP Agent option must be activated on the NV9000.

External Interface Summary		Configured Port	Protocol	License
License Summary				
	License			On Controller 1
NV9000 SNMP Agent				<input checked="" type="checkbox"/>
Probel routers				<input checked="" type="checkbox"/>
Telnet				<input checked="" type="checkbox"/>

Trinix

Routing switchers.

Vertigo XG

Advanced HD/SD graphics processor.

vFlex Multi-purpose HD Video Data Inserter (*formerly mfg'd by Softel*)

vFlex is a multi-purpose ancillary data processor that can insert a range of video data in the transport stream.

Presented as a single-unit to save rack space, vFlex performs a large variety of data processing including, ancillary data encoding and decoding, opt cuing, ad insertion, wide screen signaling as well as graphic insertion for all HD and SD environments.

The plug-in supports several alarms some of which are informational, holding device information. Only one alarm is both a true alarm and consistently present in all variations of this plug-in's runtime: the **Device Communication** alarm (in the **Health Monitoring** sub-folder). The remaining alarms belong to individual modules.

Note: Each module will have at least one *Status* alarm.

Summary

[vFlex Alarms](#), on page 123

[vFlex Configurable Parameters](#), on page 124

VFlex Alarms

Alarm name	Type	MIB point	Further details
--- Informational alarms about the device ---			
OS Platform	Text/info	osPlatform	OS platform
OS version	Text/info	osVersion	OS version
Process ID	Text/info	processID	Process ID
Process Name	Text/info	processName	Process Name
Process Started	Text/info	processStarted	Process Started
Process Priority	Text/info	processPriority	Process Priority
Process affinity	Text/info	processProcAffinity	Process affinity
Process time	Text/info	processProcTime	Process time
Process user time	Text/info	processUserProcTime	Process user time

vFlex Alarms (continued)

Alarm name	Type	MIB point	Further details
Process handle count	Text/info	processHandles	Process handle count
Process thread count	Text/info	processThreads	Process thread count
--- Health monitoring alarms ---			
Device Communication	Status/health		Raise a critical condition if the device stops responding to polling for a time period defined by pollinterval X retries.
--- Module alarms ---			
<module-specific status alarm>	Status Text/health		Module status.

vFlex Configurable Parameters

Parameter	Description
retries	If an SNMP request timeout, this defines the number of retries to be performed. Default: 3
timeout	Delay in seconds before declaring a timeout in the current SNMP request. Default: 10
uniqueID	An extra identifier to be assigned to the plugin to differentiate its alarms from the other plug-in of the same type. The <code>uniqueID</code> should be part of URI.
readCommunity	SNMP read community string. Use for SNMP polling. Default value: <code>public</code>
pollInterval	Poller interval in seconds. Overwrite the default interval of 15 seconds.

Plug-in Notes

- This plug-in uses the `generic.js` script.
- Traps are not supported.
- The RFC1213 MIB is not supported.
- OIDs with OS or process information are static. Alarm OIDs, however, are in arrays, and consequently can be dynamic. The poller performs an SNMP GET command on each

- OID of the array. Multiple varbind requests are not used since some issues have been seen during real device test.
- The Vflex MIB was created to be highly generic. It defines modules. Each modules can have a list of parameters (`moduleValue`). Each parameter has different properties:
 - `name`—used for GSM alarm name
 - `value`—used to fill GSM alarm text
 - `condition`—used to set GSM alarm status.
 - Currently, handled conditions are:
 - `ok, normal`—sets status to `NORMAL`
 - `warning`—sets status to `MINOR`
 - `error`—sets status to `CRITICAL`
 - `unknown`—sets status to `NORMAL`
 - If a condition string is not handled, the default behavior is to set status to `NORMAL`.
 - The consequence of this generic MIB and this implementation is that alarms are not known before starting the plug-in, possibly making integration more difficult.
 - Alarms are dynamic, so in every refresh period (default is 5 minutes), arrays are reconstructed.

IMPORTANT Although OIDs in arrays probably will not change during the device runtime, this should not be assumed to be the case; some cards **MAY** be hot-plugged or else software modules disconnected, which could change the available OIDs.

IMPORTANT

MIBs Used

- SOFTEL-VFLEX-MIB
- SOFTEL-GROUP-MIB

Harmonic

Ordering information

Hardware	New in iControl version	GSM plug-in name	Order number
CID-3100 Decryptor		SNMP – Harmonic CID-3100	IC-SNMP-105
Electra	5.00	SNMP – Harmonic Electra	IC-SNMP-211
MaxLINK HOA 8030		SNMP – Harmonic EDFA HOA8030	IC-SNMP-100
ProStream 1000 ★	6.20	SNMP – Harmonic ProStream1000	IC-SNMP-229
ProView 2900 Receiver/Decoder		SNMP – Harmonic ProView 2900	IC-SNMP-119
ProView 7000/7100 Integrated Receiver-Decoder and Stream Processor	6.02	SNMP – Harmonic ProView 7000/7100	IC-SNMP-119

MaxLINK HOA 8030

The Harmonic MAXLink™ HOA 8030 is a Video Optical Amplifier designed to provide optical amplification of 1550 nm RF video signals in FSAN compliant passive optical networks.

ProStream 1000

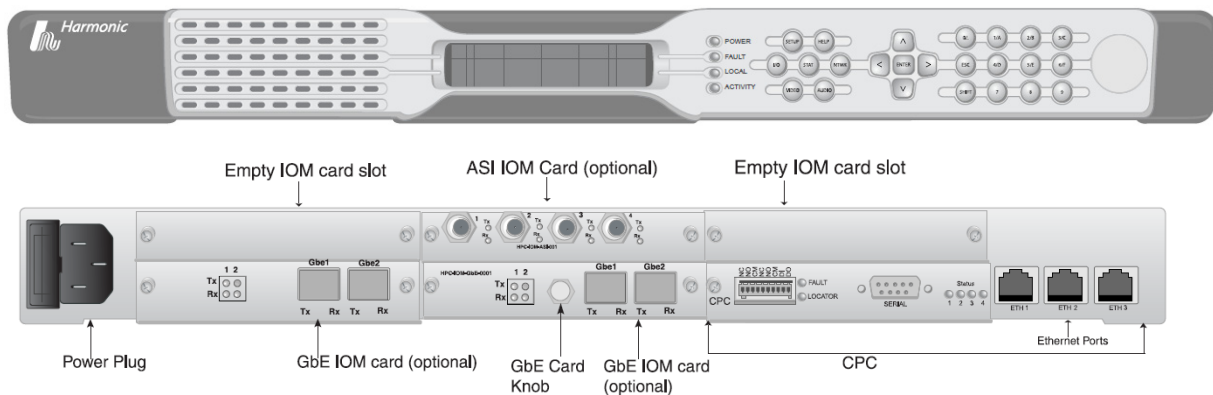

Prostream 1000 front and back panels

Harmonic's ProStream 1000 stream processing platform multiplexes and scrambles SD or HD video and audio services. With its standard IP and DVB-ASI input and output interfaces, the 1-RU ProStream 1000 is easily incorporated into any existing head-end environment for supporting digital turnaround solutions.

See the following for device support details:

- on page 144
- on page 144

Supported Devices

Front panel LEDs

LED name	Color	Meaning
Power	Green	Device is on and boot up process is complete.
	Orange	Device is on and boot up process is taking place.
Fault	Red	An alarm has been activated in the device.
Local	Orange	Identify the device, indicates the device when it needs service.
Activity	Currently not applicable	

Alarms

Alarm name	Further details
--- Platform alarms ---	
CPC Card Hw Failure	
CPC Card Temp. Sense Exceed Limits	
CPC Card Voltage Error	
NTP Connection Failure	
Front Panel Not Present	
Got New Configuration	
Platform Initializing	Occur every power-up
Auto-negotiation failed: management network	
Auto-negotiation failed: CAS network	
Background Download in progress	Raise from starting download process till device is reset
Background Download in progress - retrying	
Background Download Failed: TFTP error	
Background Download Failed: Disk Full	
Background Download Failed with an error	
Background Download was cancelled	
--- Slot alarms ---	
Card Missing	Got configuration for non existing card
Card Mismatch	
--- GbeProCard alarms ---	
GbE Card Initializing	
GbE Card HW Failure	
GbE Card Sensed Temp. Exceeds Limit	
GbE Card Voltage Error	

Alarms (*Continued*)

Alarm name	Further details
GbE Output Multicast Buffer Overflow	
GbE Input Descrambling Bitrate Exceeded	Try to descramble more than 500Mb
GbE Card Input Data Loss	
Pacer Clock Error	
GbE flash upgrade in process	During SW upgrade
--- GbePort alarms ---	
GbE Port Link Down-Cable Disconnect	
GbE Port SFP Missing	
GbE Output MPEG Buffer Overflow	
GbE Input Non MPEG Buffer Overflow	
GbE Input Inter Packet Gap Too Small	Less than 12 clks
GbE Input Invalid IP/UDP Packet Length	
GbE Auto-Negotiation Failed	
GbE Input IP Packet Missing	
GbE Input IP Packet CRC Error	
GbE Slave Channel Activated	For port redundancy
GbE Port Failed	
--- GbE Input Socket alarms ---	
GbE Input Primary Socket Not Active	
GbE Input Backup Socket Not Active	
GbE Input Socket Buffer Overflow	
Invalid Source Clock Frequency	
GbE Input Socket Lost PCR	
GbE Input Socket Erred PCR	
GbE Input Socket CBR Rate Changed	For input MPTS only
GbE Input Socket Max. Jitter Exceeded	
GbE Input Socket Timestamp Error	
GbE Backup Socket Activated	
Queue depth threshold passed	
GbE Input Primary Socket-A/V missing	
GbE Input Backup Socket-A/V missing	

Alarms (*Continued*)

Alarm name	Further details
--- GbeOutAP alarms ---	
Gbe Output Socket Not Transmitted	Can be only in unicast
Gbe Output Socket - Unreachable Dest.	Can be only in unicast
Gbe Output Buffer Overflow Level = High	
Gbe Output Buffer Overflow Level = Normal	
Gbe Output Buffer Overflow Level = Medium	
Gbe Output Buffer Overflow Level = Low	
--- Tsln alarms ---	
Tsln CC Error Detected	
Tsln MPEG Sync Loss	
Invalid CAS mode	
--- Reference Service alarms ---	
Remap Range Overflow	More PIDs than defined in the range
Input Service Missing	Not found PMT for this service
PID From Input RSS Is Missing	At least one PID
--- StreamOut alarms ---	
PID Missing	In the input
Reference PCR PID interval error	Only in generate PCR mode
--- ServiceOut alarms ---	
Backup Service1 Is Activated	For service redundancy
Service Failure	
Primary Service Failure	
Backup Service1 Failure	
Failed to Receive CW for the Service	
Invalid Response from VM Client	new
Missing ECM	new
Missing CA information	new
Undefined scrambling algorithm	new
Unsupported scrambling algorithm	new

ProView 7000/7100 Integrated Receiver-Decoder and Stream Processor



ProView 7000 (top) and ProView 7100 (bottom)

Harmonic's ProView™ 7000 and 7100 are single-rack-unit, scalable, multi-format integrated receiver-decoders (IRD), transcoders and MPEG stream processors. The ProView 7000/7100 offers broadcast-quality SD/HD MPEG-2 and MPEG-4 AVC decoding and video transcoding.

See the following for device support details:

- on page 148
- on page 150

Alarms

Alarm name	Type	Optional?	Further details
--- Health monitoring alarms ---			
Hardware failure	Text/Status	No	
Fan failure	Text/Status	No	
Fan failure	Text/Status	No	
Ethernet link down	Text/Status	No	
Critical high temperature detected	Text/Status	No	
Backup port activated	Text/Status	No	
Ethernet backup port active	Text/Status	No	
Ethernet Gbe Port fail	Text/Status	No	
High temperature warning	Text/Status	Yes	
Critical Software card error	Text/Status	Yes	
Ethernet AutoNegotiation failed	Text/Status	Yes	
Firmware download failure	Text/Status	Yes	
Firmware upgrade failure	Text/Status	Yes	
Voltage error	Text/health	Yes	

Alarms (Continued)

Alarm name	Type	Optional?	Further details
Communication Status	Status	No	Raise a critical condition if the device stops responding to polling for a time period defined by pollinterval X retries.
Device Restart	Status	No	Raise a minor condition based on the value of sysUpTime read is smaller by at least 60 seconds compared to last reading. The value increase by 100 every second.
System uptime	Text/Status	No	
--- MPEG alarms ---			
MPEG Sync loss	Text/Status	No	
Output overflow	Text/Status	No	
Program Decoding failure	Text/Status	No	
DSR sync loss	Text/Status	No	
Continuity error on primary port	Text/Status	No	
Input overflow	Text/Status	No	
Program decoding Failure PCR err	Text/Status	Yes	
Program decoding failure unsupported	Text/Status	Yes	
Framrate mismatch	Text/Status	Yes	
Low delay stream in normal mode	Text/health	Yes	
AC gen lock not synched	Text/Status	Yes	
AC Eth dejitter fail	Text/Status	Yes	
Pid Conflict	Text/health	Yes	
MPEG synch loss on backup port	Text/Status	Yes	
Continuity error on backup port	Text/Status	Yes	
Pid missing on primary port	Text/Status	Yes	
Pid missing error on backup port	Text/Status	Yes	
xcoder engine failure	Text/Status	Yes	
xcoding unsupported content	Text/Status	Yes	
xcoding Scrambled input	Text/Status	Yes	
xcoding DTS PTS errors	Text/Status	Yes	
xcoding PCR error	Text/Status	Yes	
xcoding pid missing	Text/Status	Yes	
xcoding input errors	Text/Status	Yes	
xcoding Resolution Mismatch	Text/Status	Yes	

Alarms (Continued)

Alarm name	Type	Optional?	Further details
xcoding Codec Mismatch	Text/Status	Yes	
ac Dec Resolution Mismatch	Text/Status	Yes	
ac Vmx Descr Over Provision	Text/Status	Yes	
ac Vmx Descr Init Failure	Text/Status	Yes	
ac Dr Activated	Text/Status	Yes	
ac Dr Scanning	Text/Status	Yes	
ac Dr Alt Uplink Active	Text/Status	Yes	
ac Mux In Dejitter Failure	Text/Status	Yes	
ac Mux In Dejitter Failure Backup	Text/health	Yes	
ac T2mi Pid Missing On Primary Port	Text/Status	Yes	
ac T2mi Pid Missing On Backup Port	Text/Status	Yes	
ac T2mi Not Detected On Primary Port	Text/Status	Yes	
ac T2mi Not Detected On Backup Port	Text/Status	Yes	
ac T2mi Plp Missing On Primary Port	Text/Status	Yes	
ac T2mi Plp Missing On Backup Port	Text/Status	Yes	
--- RF alarms ---			
cam Missing	Text/Status	No	
carrier Not Detected	Text/Status	No	
demodulation Failure	Text/Status	No	
input Failure	Text/Status	No	
satellite Ber TooHigh	Text/Status	Yes	
satellite Ebn Too Low	Text/Status	Yes	
program Xc Not Descrambled	Text/Status	Yes	
cam Packet Loss	Text/Status	Yes	
cam Zero Bitrate	Text/Status	Yes	
cam Descrambling Failure	Text/Status	Yes	
satellite Per Too High	Text/Status	Yes	
cam Input Overflow	Text/Status	Yes	
embedded Descrambler Input Overflow	Text/Status	Yes	
input Bitrate Overflow	Text/Status	Yes	

Configurable parameters

Parameter	Description
<code>alarmPath</code>	Force a Path where to create the plugin alarms
<code>pollInterval</code>	Fast poller interval in seconds. Overwrite the default interval of 20 seconds.
<code>retries</code>	If an SNMP request timeout, this defines the number of retries to be performed. Default is 1.
<code>timeout</code>	Delay in seconds before declaring a timeout in the current SNMP request.
<code>uniqueID</code>	An extra identifier to be assigned to the plugin to differentiate its alarms from the other plugin of the same type. The uniqueID should be part of uri.
<code>readCommunity</code>	SNMP read community string. Use for SNMP polling.
<code>lightweightDriver</code>	Set the plugin to monitor only criticals alarms. Default is false.
<code>signalForcedSeverity</code>	Text indicating the forced severity for service alarms. Possible values: CRITICAL, MAJOR, MINOR
<code>healthForcedSeverity</code>	Text indicating the forced severity for health alarms. Possible values: CRITICAL, MAJOR, MINOR

Harris (Leitch)

Ordering information

Hardware	New in iControl version	GSM plug-in name	Order number
IconStatus Channel Branding	4.30	SNMP – Harris IconStation	IC-SNMP-148
NetPlus M400 Integrated Receiver/Decoder	4.30	SNMP – Harris NetPlus M400	IC-SNMP-156
NetVX Contribution Encoder		SNMP – Harris NetVx Frame	IC-SNMP-157
Panacea Routing Switcher ★	6.20	SNMP – Harris Panacea	IC-SNMP-096

IconStatus Channel Branding

IconStation is an on-air advanced channel branding system that simplifies the creation, display and maintenance of a consistent brand.

NetPlus M400 Integrated Receiver/Decoder

The NetPlus™ M400 is a broadcast-grade, satellite integrated receiver/decoder (IRD) that supports a wide range of global standards for video and audio compression. It includes DVB-S/S2 demodulation capabilities and inputs for DVB-ASI and IP. Additionally, the NetPlus M400 supports MPEG-2 and H.264 video compression — from the 4:2:2 format to SD and HD formats — as well as MPEG, Dolby® Digital AAC and SMPTE 302 audio systems.

Panacea Routing Switcher



The Panacea™ routing switcher offers a large selection of matrix sizes, options and built-in control features.

See the following for details of iControl's support of IVMS:

- on page 152
- on page 152
- on page 154

Parameters (non-configurable)

Parameter	Description	Default value
<code>pollInterval</code>	Fast poller interval in seconds. Overwrite the default interval.	20
<code>retries</code>	If an SNMP request times out, this defines the number of retries to be performed.	1
<code>timeout</code>	Delay in seconds before declaring a timeout in the current SNMP request.	2
<code>uniqueID</code>	An extra identifier to be assigned to the plugin to differentiate its alarms from the other plugin of the same type. The <code>uniqueID</code> should be part of URI.	""
<code>readCommunity</code>	SNMP read community string, used for SNMP polling.	public
<code>writeCommunity</code>	SNMP write community string, used to send SNMP-set commands.	public

Alarms

GSM alarm name	Type	Poll/Trap	Description	Alarm URI	MIB node name
<code>Device ID</code>	Text	Poll	Device frame hardware ID	snmp://Panacea:{IPADDRESS}/deviceID	<code>deviceID</code>
<code>Device Name</code>	Text	Poll	Name of the routing device	snmp://Panacea:{IPADDRESS}/deviceName	<code>deviceName</code>

Supported Devices

Alarms (Continued)

GSM alarm name	Type	Poll/ Trap	Description	Alarm URI	MIB node name
Router Type	Text	Poll	Device type of the router	snmp://Panacea:{IPADDRESS}/deviceProductType	deviceProductType
Communication Status	Status	Poll	Device communication alarm set by receiving a successful/failed event in the poller	snmp://Panacea:{IPADDRESS}/deviceCommState	sysUpTime (RFC1213)
Configuration State	Status	Poll	Indicates the configuration state: 1. OK 2. Error 3. Undetermined	snmp://Panacea:{IPADDRESS}/deviceConfigState	deviceConfigState
Control State	Status	Poll	Indicates the control state: 1. OK 2. Error 3. Undetermined	snmp://Panacea:{IPADDRESS}/deviceControlState	deviceControlState
Device Reboot	Status	Poll	Device power cycle alarm. Status determined comparing subsequent polling of the system up time variable	snmp://Panacea:{IPADDRESS}/powerCycle	sysUpTime (RFC1213)
Fan Status #	Status	Poll	Status of an individual fan. 1. OK 2. Error 3. Undetermined	snmp://Panacea:{IPADDRESS}/deviceFansStatus-#{}	deviceFanStatus
Number of Fans	Text	Poll	Number of entries in the Devices' fan information table	snmp://Panacea:{IPADDRESS}/deviceNumFans	deviceNumFans
IP Address #	Text	Poll	IP Address assigned to Interface	snmp://Panacea:{IPADDRESS}/deviceIPSettingsIpAddress-#{}	deviceIPSettingsIpAddress
Number of IP address	Text	Poll	Number of entries in the Devices' IP address information table	snmp://Panacea:{IPADDRESS}/deviceNumIpAddresses	deviceNumIpAddresses
Number of PSUs	Text	Poll	Number of entries in the Devices Power-supply information table	snmp://Panacea:{IPADDRESS}/deviceNumPSUs	deviceNumPSUs

Alarms (Continued)

GSM alarm name	Type	Poll/ Trap	Description	Alarm URI	MIB node name
PSU status #	Status	Poll	Status of an individual power supply 1. Installed and working 2. Installed and not working 3. Presence can not be determined but no failure is indicated 4. Presence can not be determined	snmp://Panacea:{IPADDRESS}/devicePSUStatus-#{}	devicePSUStatus
Number of Syncs	Text	Poll	Number of entries in the Devices' sync information table	snmp://Panacea:{IPADDRESS}/deviceNumSyncs	deviceNumSyncs
Sync Source status #	Status	Poll	The current	snmp://Panacea:{IPADDRESS}/deviceSyncsStatus-#{}	deviceSyncsStatus

- {IPADDRESS} represents the IP address of the actual or the emulated Harris Panacea Device
- {#} symbol represents multiple instances of the alarm will be displayed on the GSM alarms since we are dealing with a table alarm. The # symbol will be replaced by integers starting from 1 for each table entries.
- The MIB node names refer to the Harris Panacea's MIB (LEITCH-ROUTER-MIB) unless specified to be found in the (RFC1213).

Traps

Trap name	Type	Description
deviceNameEvent	Text	This alarm is reported if the device name is changed.
deviceConfigStateEvent	Status	This alarm is reported if the system configuration is not valid for the system hardware.
deviceControlStateEvent	Status	This alarm is reported if the device control state changes.
deviceIPSettingsIpAddressEvent	Text	This alarm is reported if there is a change in an IP address
deviceFanStatusEvent	Status	This alarm is reported if there is a change in a fans operational state
devicePSUStatusEvent	Status	This alarm is reported if there is a change in a power supply's operational state
deviceSyncsStatus	Status	This alarm is reported if there is a change in the external sync source, if supported

Hewlett Packard

Ordering information

Hardware	New in iControl version	GSM plug-in name	Order number
P2000 SAN Storage		SNMP – HP P2000 SAN Storage	IC–SNMP–199
ProLiant DL-Series Enterprise Servers	5.00	SNMP – HP DL Series	IC–SNMP–214

Huawei

Ordering information

Hardware	New in iControl version	GSM plug-in name	Order number
iManager I2000 NMS System		SNMP – Huawei I2000 NMS system	IC–SNMP–228

iManager I2000 NMS System

Huawei's iManager I2000 NMS System provides network management solutions covering several fields including voice, data, operational support, and 3G and IMS-integrated service, as well as northern interfaces, to support operators as they construct integrated network management.

Hy-gain

Ordering information

Hardware	New in iControl version	GSM plug-in name	Order number
DCU-1	4.10	SERIAL – Hygain DCU1	

DCU-1

The Hygain DCU1 Pathfinder digital control unit is used to control and steer the HAM-V antenna rotator system.

IETF

Ordering information

Hardware	New in iControl version	GSM plug-in name	Order number
HOST-RESOURCES MIB		SNMP Host Resource MIB	IC-SNMP-148
Internet Control Message Protocol (ICMP)			
MIB-II (RFC 1213)		SNMP RFC1213	
RMON (RFC 2819)		SNMP RMON	IC-SNMP-002

HOST-RESOURCES MIB

The HOST-RESOURCES MIB, developed by the Internet Engineering Task Force (IETF), is for use in managing host systems. The term *host* is construed to mean any computer that communicates with other similar computers attached to the internet and that is directly used by one or more human beings. Although this MIB does not necessarily apply to devices whose primary function is communications services (e.g., terminal servers, routers, bridges, monitoring equipment), such relevance is not explicitly precluded. This MIB instruments attributes common to all internet hosts including, for example, both personal computers and systems that run variants of Unix.

Internet Control Message Protocol (ICMP)

The Internet Control Message Protocol (ICMP), developed by the Internet Engineering Task Force (IETF), is used by a gateway or destination host to communicate with a source host, for example, to report an error in datagram processing.

MIB-II (RFC 1213)

RFC 1213, developed by the SNMP Working Group of the Internet Engineering Task Force (IETF), defines the second version of the Management Information Base (MIB-II) for use with network management protocols in TCP/IP-based internets. In particular, together with its companion memos which describe the structure of management information (RFC 1155) along with the network management protocol (RFC 1157) for TCP/IP-based internets, these documents provide a simple, workable architecture and system for managing TCP/IP-based internets and in particular the Internet community.

RMON (RFC 2819)

Remote Monitoring (RMON) is an Internet Engineering Task Force (IETF) standard that enables various network monitors and console systems to exchange monitoring data. It is used in telecommunications equipment, such as routers, that implement a MIB (Management Information Base) which supports remote monitoring. RMON uses an agent running on the device being monitored to supply information over SNMP to a monitoring/control system (e.g. iControl).

IneoQuest

Ordering information

Hardware	New in iControl version	GSM plug-in name	Order number
IVMS Video Management System	4.40	SNMP – IneoQuest IVMS	IC-INEOQUEST-IVMS
Singulus G1-T	6.04	SNMP – IneoQuest Singulus	IC-SNMP-085

IVMS Video Management System

The IVMS video management system is a real-time, end-to-end performance monitoring system of video distribution networks. IVMS is an SNMP server to which all Ineoquest probes may connect. These probes are:

- IQ LBAND probe—Ineoquest *Plurys*
- IQ IP probe—Ineoquest *Expedus*
- IQ QAM probe—Ineoquest *Cricket*

When a probe detects a problem along the path, an error is set to IVMS. The IVMS SNMP plugin can fetch alarms or handle SNMP traps. In iControl, GSM alarms can be set using two different mechanisms:

- polling the active alarm table
- using an SNMPv2 trap

Configurable parameters

Parameter	Description
<code>alarmPath</code>	Force a Path where to create the plugin alarms.
<code>omitMuxNames</code>	If true, then use Probe/Service only to identify alarms. When creating alarms, Initial list array can be configured with or without Mux names identification level. It seems the plugin evolved : using mux name is the old way.
<code>pollInterval</code>	Fast poller interval in seconds. Overwrite the default interval of 20 seconds.
<code>tunnelingTrapHost</code>	IP address of tunneling appserver, if any.
<code>useLongAlarmNames</code>	If true, append probe/Mux/Service names to service alarm name.
<code>readCommunity</code>	SNMP read community string. Use for SNMP polling.
<code>writeCommunity</code>	SNMP write community string. Use to send SNMP-set commands.
<code>alarmTextSeparator</code>	Separator of alarms text in a string. Used in overall text to describe all active alarms.
<code>clearedAlarmText</code>	Text to set in overall alarm when alarms are cleared.
<code>retries</code>	If an SNMP request timeout, this defines the number of retries to be performed. Default is 1.

Configurable parameters (*Continued*)

Parameter	Description
<code>timeout</code>	Delay in seconds before declaring a timeout in the current SNMP request.
<code>uniqueID</code>	An extra identifier to be assigned to the plugin to differentiate its alarms from the other plugin of the same type. The uniqueID should be part of uri.
<code>Polling_Port</code>	Remote Port number to use for SNMP polling
<code>Trap_Port</code>	Local port number to open for SNMP trap handling
<code>alarmLevel</code>	GSM alarm level to set when an IVMS alarm is detected
<code>pollingSeverities</code>	
<code>trapSeverities</code>	
<code>useDetailedAlarms</code>	
<code>initialList</code>	Initial array to configure IVMS plugin ; unique couple of Probe/Service, or probe/Mux/Service, depending on omitMuxNames parameter.
<code>monitorTS</code>	If set to true, Transport stream alarms will be monitored. Default is false.
<code>realSeverity</code>	If set to true, the alarm status (overall and detailed alarms for both programs and TS) are set according this map: iVMS ---> GSM alarm CRITICAL CRITICAL MAJOR MAJOR MINOR MINOR Default is false. It means that alarms are set with a fixed error level (which can be configured with <code>alarmLevel</code>).
<code>progAlarmLevel</code>	Set the program alarm level. 2 by default (value used in legacy projects). We are not sure of the difference between Level 2 and Level 3 for programs alarms.
<code>tsAlarmLevel</code>	Set the Transport stream alarm level. 3 by default (advised by Ineoquest support because alarms are aggregated).

MIBs used

MIB	MIB file name
IneoQuest North-bound Interface MIB	IQNorthboundInterface.mib
IneoQuest Mediamon MIB	IQMEDIAMON-MIB.mib

GSM Alarms

GSM alarms are created for every services on a given probe.

Singulus G1-T

The Singulus G1-T is an advanced network development & analysis system for media-over-IP enabled networks. The Grass Valley driver supports the Singulus G1-T video-over-IP probe.

The Singulus G1-T is a multi-functional platform for monitoring, analyzing, troubleshooting, test and measurement of video networks. The Singulus G1-T connects to the video network through a 10/100/1000 Ethernet port and provides either network traffic generation (Stimulus) or monitoring and analysis. Based on reconfigurable technology, the Singulus G1-T allows the user to configure the hardware into alternate modes of operation. The Singulus G1-T can be configured as an advanced development and troubleshooting platform or a simple remote video monitoring platform. The user can easily switch operational modes using a web page interface.

- on page 159
- on page 159

Alarms provided by the driver

Alarm name	Type	Poll/Trap	Alarm URI	MIB node name	OID
Device Communication	Status	Poll	deviceCommAlarm		
Device Restart	Status	Poll	deviceRestartAlarm		
System Uptime	Text	Poll	sysUpTime	sysUpTime	.1.3.6.1.2.1.1.3
Current Bitrate	Text	Poll	Stream__My_ioQCMediaStreamAddress_strin/ioQCMediaStreamCurrentBitRate	ioQCMediaStreamCurrentBitRate	.1.3.6.1.4.1.15181.101.1.2.4.6.1.10
MDI Delay Factor	Text	Poll	Stream__My_ioQCMediaStreamAddress_strin/ioQCMTransportStreamMDIDF	ioQCMTransportStreamMDIDF	.1.3.6.1.4.1.15181.101.1.2.4.7.1.6
MDI Loss Rate	Text	Poll	Stream__My_ioQCMediaStreamAddress_strin/ioQCMTransportStreamMDILossRate	ioQCMTransportStreamMDILossRate	.1.3.6.1.4.1.15181.101.1.2.4.7.1.7
MDI Total Loss	Text	Poll	Stream__My_ioQCMediaStreamAddress_strin/ioQPMGraphIv1MDITotalLoss	ioQPMGraphIv1MDITotalLoss	.1.3.6.1.4.1.15181.101.1.4.4.1.6
Stream Address	Text	Poll	Stream__My_ioQCMediaStreamAddress_strin/ioQCMediaStreamAddress	ioQCMediaStreamAddress	.1.3.6.1.4.1.15181.101.1.2.4.6.1.5
Stream Current Status	Status	Poll	Stream__My_ioQCMediaStreamAddress_strin/ioQPMStreamIv1Status	ioQPMStreamIv1Status	.1.3.6.1.4.1.15181.101.1.4.5.1.7
Number Of Active Streams	Text	Poll	ActiveStreamNumber		

Certain parameters can be passed to the driver, as follows:

Parameters

Name	Description/Notes	Default value	Configurable in GUI
<code>pollInterval</code>	Poller interval in seconds. Overwrite the default interval.		No
<code>retries</code>	If an SNMP request times out, this defines the number of retries to be performed.	1	No
<code>timeout</code>	Delay in seconds before declaring a timeout in the current SNMP request.		No
<code>uniqueID</code>	An extra identifier to be assigned to the plugin to differentiate its alarms from the other plugin of the same type. The unique ID should be part of the URI.		No
<code>readCommunity</code>	SNMP read community string, used for SNMP polling.	Public	No
<code>writeCommunity</code>	SNMP write community string, used to send SNMP-set commands.		No

Infortrend

Ordering information

Hardware	New in iControl version	GSM plug-in name	Order number
SAN Storage		SNMP – Infortrend SAN Storage	IC-SNMP-200

SAN Storage

Infortrend's storage systems for SAN environments are designed to meet the needs of SMBs and mid-range and large enterprises. Infortrend's SAN storage solutions provide a comprehensive set of data services, including virtualized SAN storage solutions, local and remote replication, and thin provisioning.

Intel

Ordering information

Hardware	New in iControl version	GSM plug-in name	Order number
SR-Series Server Systems		SNMP – Intel SR-Series Server Systems	IC-SNMP-201

SR-Series Server Systems

The Intel SR-series server systems are rack-optimized, highly integrated server systems for high-density, energy-efficient applications. This family of server systems have as target applications, high-performance computing, video server, virtualization platform, and general purpose data center building blocks.

International Datacasting Corp. (formerly Logic Innovations)

Ordering information

Hardware	New in iControl version	GSM plug-in name	Order number
IPE-4000	6.02	SNMP - Logic Innovations IPE-4000	IC-SNMP-242
RS-1100	6.02	SNMP - Logic Innovations RS-1100	IC-SNMP-243
TSx-2800	6.03	SNMP - Logic Innovations TSx2800	IC-SNMP-251

IPE-4000



The Logic Innovation IPE-4000 is a Linux-based IP Encapsulator. The IPE-4000 provides the necessary link between IP networks and broadband DVB or ATSC networks.

See on page 161 for device support details:

Alarms

Alarm name	MIB point	Further details
Firmware	aboutFirmware	
Uptime	aboutUptime	
system Clock	systemClock	
system Temp Processor	systemTempProcessor	
system Temp System	systemTempSystem	
system Temp Dimm	systemTempDimm	
system Fan Speed 1	systemFanSpeed1	
system Fan Speed 2	systemFanSpeed2	
system Fan Speed 3	systemFanSpeed3	
system Fan Speed 4	systemFanSpeed4	
system Voltage In 0	systemVoltageIn0	
system Voltage In 1	systemVoltageIn1	
system Voltage In 2	systemVoltageIn2	
system Voltage In 3	systemVoltageIn3	

Alarms (Continued)

Alarm name	MIB point	Further details
system Voltage In 4	systemVoltageIn4	
Data Speed	networkDataSpeed	
Data Duplex	networkDataDuplex	
Data Rx Packets	networkDataRxPackets	
Data Rx Bytes	networkDataRxBytes	
Data Rx Errors	networkDataRxErrors	
Data Rx Drops	networkDataRxDrops	
Data Tx Packets	networkDataTxPackets	
Data Tx Bytes	networkDataTxBytes	
Data Tx Errors	networkDataTxErrors	
Data Tx Drops	networkDataTxDrops	
Mnc Speed	networkMncSpeed	
Mnc Duplex	networkMncDuplex	
Mnc Rx Packets	networkMncRxPackets	
Mnc Rx Bytes	networkMncRxBytes	
Mnc Rx Errors	networkMncRxErrors	
Mnc Rx Drops	networkMncRxDrops	
Mnc Tx Packets	networkMncTxPackets	
Mnc Tx Bytes	networkMncTxBytes	
Mnc Tx Errors	networkMncTxErrors	
Mnc Tx Drops	networkMncTxDrops	
buffer overrun	bufferOverrunAlarmStatus	Notification sent out when the buffer overrun alarm changes status

RS-1100

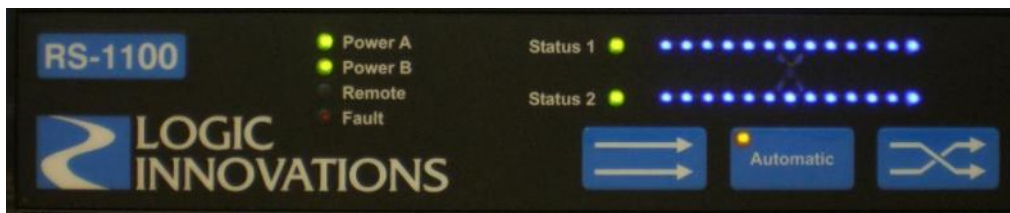

International Datacasting's RS-1100 is a 75-ohm broadband transfer switch that offers broadcasters and teleport operators the ability to obtain higher signal reliability in an efficient

1-RU, half width device. In the case of a fault, the RS-1100 performs a switch to keep a system on the air.

See on page 163 for device support details:

Alarms

Alarm name	Type	Polling or trap?	MIB point	Further details
--- Health monitoring alarms ---				
Device Communication	Status/health	Poller	sysUpTime (RFC1213)	Device communication alarm set by receiving a successful/failed event in the poller
Device Restart	Status/health	Poller	sysUpTime (RFC1213)	Raise a minor condition based on the value of sysUpTime read is smaller by at least 60 seconds compared to last reading. The value increase by 100 every second.
System uptime	text/health	Poller	sysUpTime (RFC1213)	System up time alarm, this is a default health monitoring alarm when you use the generic.js to create a new custom driver
--- Signal alarms ---				
hw_revision	Text	Fast poller	hw_revision	
sw_version	Text	Fast poller	sw_version	
serial_number	Text	Fast poller	serial_number	
fault input 1	Status	Fast poller	fault_input_1	
fault input 2	Status	Fast poller	fault_input_2	
power A	Status	Fast poller	power_A_status	
power B	Status	Fast poller	power_B_status	
control_source	Text	Fast poller	control_source	
fp_force_mode	Text	Fast poller	fp_force_mode	
contact closure	Status	Fast poller	input_contact_closure	
switch mode	Text	Fast poller	switch_mode	
switch state	Text	Fast poller	switch_state	
fault output	Status	Fast poller	fault_output	

TSX-2800



The plug-in can support two types of device:

- TSS-2800—Transport Stream Switch
- TSM-2800—Transport Stream Multiplexer

This plug-in uses the `generic.js` script. All alarms can be polled (static OIDs). The plug-in supports both polling and traps. Traps are supported for input / output status. SNMP OIDs are monitored only, not driven. Some alarms use a parameter so as to detect if it should be raised or not:

- Health alarms (temperature, voltage)
- Active output

In every case, the parameter default value prevents dedicated alarms from being raised. Threshold or main output should be checked while integrating plug-in / device.

See the following for details of iControl's support of IVMS:

- on page 164
- on page 166

Alarms

Alarm name	Type	MIB point	Further details
--- Health monitoring alarms ---			
Device Communication	status	<code>sysUpTime</code> (RFC1213)	Created and monitored by generic.js
Device Restart	status		Created and monitored by generic.js
System uptime	text		Created and monitored by generic.js
temperature 1	status/text	<code>temperature1</code>	temperature - can raise an alarm if temperature > threshTemp
temperature 2	status/text	<code>temperature2</code>	temperature - can raise an alarm if temperature > threshTemp
voltage 5	status/text	<code>voltage5</code>	monitor 5V - can raise an alarm if voltage > (5 + deltaVolt) or voltage < (5 - deltaVolt)

Alarms (Continued)

Alarm name	Type	MIB point	Further details
voltage 12	status/text	voltage12	monitor 12V - can raise an alarm if voltage > (12 + deltaVolt) or voltage < (12 - deltaVolt)
voltage 15	status/text	voltage15	monitor 1.5V - can raise an alarm if voltage > (1.5 + deltaVolt) or voltage < (1.5 - deltaVolt)
voltage 18	status/text	voltage18	monitor 1.8V - can raise an alarm if voltage > (1.8 + deltaVolt) or voltage < (1.8 - deltaVolt)
voltage 33	status/text	voltage33	monitor 3.3V - can raise an alarm if voltage > (3.3 + deltaVolt) or voltage < (3.3 - deltaVolt)
--- Info alarms ---			
Bootcode version	text	bootcodeVersion	
Hardware version	text	hardwareVersion	
Software version	text	softwareVersion	Can be useful to memorize this value to ease future integration.
mac Address	text	macAddress	
Nb input channel licensed	text	licensedInputChannels	The TSx2800 has 8 inputs. But its input number can be limited with a license.
Product name	text	productName	
unit name	text	unitName	
--- Inputs alarms¹ ---			
CableStatus	status	inputCableStatus	Reports whether the channel is enabled for a given input channel.
ChannelEnable	status	inputChannelEnable	Reports whether the external fault is detected for a given input channel.
FaultRelayStatus	status	inputFaultRelayStatus	Reports whether the input cable is connected for a given input channel.
SyncStatus	status	inputSyncStatus	Reports whether the input transport stream lost sync for a given input channel
--- Output alarms² ---			
Active output	status	switchActiveOutput	Active output channel
output Fault Relay	status	outputFaulted	Reports whether the output is faulted
Current Virtual Output	status/text	currentVirtualOutputStatus	Current output good/not good.
Virtual Output	status/text	virtualOutputStatus	Good virtual output exists/does not exist
--- Switch Conf alarms³ ---			
fault if no valid Output	text	faultOnNoValidOutput	Drive fault out when no output channel can switched to that is 100%

Alarms (Continued)

Alarm name	Type	MIB point	Further details
Mode	text	<code>switchMode</code>	Select either minimal switching or preferred primary switching mode
On Sync Loss	text	<code>switchOnSyncLoss</code>	Enables a switch on input channel sync loss
Return delay	text	<code>switchReturnDelay</code>	Select the delay before returning to a valid higher priority output channel
Tuning	text	<code>switchTuning</code>	Milli-second tuning value.

1. There is a physical limitation of 8 inputs. All these alarms exists for every input. Inputs and associated alarms may not exist according to the license.
2. There is a physical limitation of 4 outputs. These alarms are global and NOT duplicated for each output.
3. This is useful information about the switch configuration and what can trigger the output switch.

Configurable parameters

Parameter	Description
<code>pollInterval</code>	Poller interval in seconds
<code>retries</code>	If an SNMP request timeout, this defines the number of retries to be performed. Default is 1.
<code>timeout</code>	Delay in seconds before declaring a timeout in the current SNMP request.
<code>uniqueID</code>	An extra identifier to be assigned to the plugin to differentiate its alarms from the other plugin of the same type. The uniqueID should be part of uri.
<code>threshTemp</code>	Threshold before raising temperature alarm. Default value : 100.
<code>deltaVolt</code>	Raise alarm when voltage nominal value differs more than this value. Default value : 20. For example, with monitored 12Volts, alarms is raised when voltage goes under -8V or is above 38V.
<code>mainOutput</code>	Set which output should be the main one. Raise <code>activeOutput</code> alarm to <code>WARNING</code> if active output is not the main one. Default is "", so main output is not configured and consequently active output alarm is never raised.

TSM-2800

The TSM-2800 provides extensive table processing and stream grooming and analysis capabilities for combining and manipulating streams. Support for opportunistic data and PSIP insertion provides operators with the ability to tailor streams for local broadcasts and fully utilize available bandwidth.

IRTrans

Ordering information

Hardware	New in iControl version	GSM plug-in name	Order number
LAN Controller XL Infrared Control System		SNMP – IRTrans LAN Controller XL	IC-DR-016

LAN Controller XL Infrared Control System

The IRTrans LAN Controller XL is an infrared LAN controller with eight IR outputs, an RS232 interface, 2 inputs for external receivers, 4 relay outputs, and a 10/100 Mb Ethernet connection.

Isilon

Please see [EMC](#), on page 30.

JDSU

Ordering information

Hardware	New in iControl version	GSM plug-in name	Order number
MVP-200 MPEG Video Probe		SNMP – JDSU MVP-200	IC-SNMP-162
VSA API v2	6.02		IC-SNMP-255

VSA API v2

The VSA is an MPEG-2 Video Probe. The VSA typically supports a 4-port Napatech Gigabit card and can run MPEG-2 analysis on each port simultaneously.

See on page 167 for device support details:

Alarms

Alarm name	Type	Further details
--- Health monitoring alarms ---		
Communication	Status/health	Raise a critical condition if the device does not respond to HTTP request or does not respond with HTTP code 200.
Notification ready	Status/health	Set to critical condition at start. The status is cleared as soon as a notification is received.
Board [X] Status	StatusText	There is an alarm for each board seen by the plugin. State can be normal / "monitoring", or critical / "idle".
AlarmCount	Text	Shows the number of "statefull" alarms that are read from "nmap" query. If lightweight_driver is set, then this alarm should show 0.
API version	Text	Show the VSA API version of the device
--- Streams alarms ---		
Overall	Status	Virtual alarm for status and detailed alarms.
Status	Status	Overall alarm given by the VSA for the stream.

Lawo

Ordering information

Hardware	New in iControl version	GSM plug-in name	Order number
Nova73 Digital Audio Matrix		SNMP – Lawo Nova73	IC-SNMP-089

Nova73 Digital Audio Matrix

Audio router/encoder.

Leitch

Please see [Harris \(Leitch\)](#), on page 151.

Met One Instruments

50.5 Wind Sensor

Automatic Weather System (AWS) wind sensor.

Microsoft

Ordering information

Hardware	New in iControl version	GSM plug-in name	Order number
Interactive Program Guide		SNMP – Microsoft IPG Server	IC-SNMP-106
Windows 7		SNMP Host Resource MIB	IC-SNMP-135
Windows® SNMP Agent			

Interactive Program Guide

Windows 7

Windows® SNMP Agent

The HostResources driver can be used to measure the amount of storage space remaining on a host running Windows. The SNMP Agent component must be enabled first. The alarms are repeated per storage device on the host computer.

Miteq Inc.

Ordering information

Hardware	New in iControl version	GSM plug-in name	Order number
Modulator 172138	6.02	SNMP – Miteq modulator	IC-SNMP-247
NSU1 160061	6.02	SNMP – Miteq NSU1 Switchover	IC-SNMP-246

Modulator 172138

A modulator commonly varies some aspect (amplitude, phase or frequency) of an RF carrier (f_c) in proportion to a much lower frequency video or digital input signal (f_m). In general, the input frequency components of the modulation typically extend from DC to 100 MHz, except for fast data links.

In order to preserve the information content superimposed on the RF carrier, one must insure that the output system bandwidth is adequate to pass both upper and lower sidebands (i.e. $f_c + f_m$) without distortion. In fact, system amplifier and channel distortion often will add residual AM or PM modulation to an otherwise clean transmitter.

See the following for device support details:

- on page 170
- on page 171

Alarms

Alarm name	Type	MIB point	Further details
--- Health monitoring alarms ---			
<i>Theses alarms are created by generic.js</i>			
Device Communication	Status/health	<code>sysUpTime</code> (RFC1213)	Raise a critical condition if the device stops responding to polling for a time period defined by <code>pollinterval X</code> retries.
Device Restart	Status/health	<code>sysUpTime</code> (RFC1213)	Raise a minor condition based on the value of <code>sysUpTime</code> read is smaller by at least 60 seconds compared to last reading. The value increase by 100 every second.
--- Info alarms ---			
<i>Theses alarms are created by the plug-in itself</i>			
Transfer Switch Mode	Status/health	<code>xferSwflt</code>	Transfer Switch Indicator switch fault status
Summary Alarm	Status/health	Summary Alarm	Summary (overall) Alarm status
+15V Supply rail	StatusText/health	<code>pos15rail</code>	+15.3V Supply rail. Alarm is set to CRITICAL when the measured voltage is under the parameter <code>pos15vThresh</code> .

Alarms (Continued)

Alarm name	Type	MIB point	Further details
+5V Supply rail A	StatusText/health	pos5Arail	+5V Supply rail A. Alarm is set to CRITICAL when the measured voltage is under the parameter pos5VThresh.
+5V Supply rail B	StatusText/health	pos5Brail	+5V Supply rail B. Alarm is set to CRITICAL when the measured voltage is under the parameter pos5VThresh.
-15V Supply rail	StatusText/health	neg15rail	-15V Supply rail. Alarm is set to CRITICAL when the measured voltage is above the parameter neg15vThresh.
Temperature	Text/health	temperature	Temperature in degrees C
Local Oscillator Lock Alarm	Status/health	moreStatus	Local Oscillator Lock Alarm
Power supply Alarm	Status/health	moreStatus	Power Supply Alarm
Local Oscillator Level Alarm	Status/health	moreStatus	Local Oscillator Level Alarm (Optional)
Amplifier Current Alarm	Status/health	moreStatus	Amplifier Current Alarm (Optional)
External Alarm	Status/health	moreStatus	External Alarm
Temperature Alarm	Status/health	moreStatus	Temperature Alarm (Optional)
Module communications Alarm	Status/health	moreStatus	Module communications Alarm (Optional)

--- Status path alarms ---

frequency	Text/health	moreStatus	Frequency in Hz
attenuation	Text/health	moreStatus	attenuation
attenuation 2	Text/health	moreStatus	optional second attenuation
attenuation 3	Text/health	moreStatus	optional third attenuation
control	Text/health	moreStatus	local or remote
intermediate freq	Text/health	moreStatus	intermediate frequency
mute	Text/health	moreStatus	muted or not
reference	Text/health	moreStatus	internal/external reference
polarization	Text/health	moreStatus	polarization (none, horizontal, vertical)
setup title	Text/health	moreStatus	Setup Title
slope	Text/health	moreStatus	Slope in dB
impedance	Text/health	moreStatus	50 ohm or 75 ohm

Configurable parameters

Parameter	Description
<code>AlarmPath</code>	Used to set the Alarm prefix. Default: <code>PBI</code> . Could be replaced by <code>IRD</code> so as to have legacy plug-ins tree look-like.
<code>pollInterval</code>	Poller interval in seconds. Overwrite the default interval of 20 seconds.
<code>retries</code>	If an SNMP request times out, this defines the number of retries to be performed. Default: <code>1</code> .
<code>timeout</code>	Delay in seconds before declaring a timeout in the current SNMP request.
<code>uniqueID</code>	An extra identifier to be assigned to the plug-in to differentiate its alarms from the other plug-in of the same type. The <code>uniqueID</code> should be part of the URI.
<code>readCommunity</code>	SNMP read community string. Use for SNMP polling. Default: <code>public</code>
<code>pos15vThresh</code>	Threshold for +15V voltage supervisor. Default: <code>5V</code> The alarm +15V Supply rail becomes critical when the measured voltage is under the threshold.
<code>pos5vThresh</code>	Threshold for +5V voltage supervisor . Default: <code>2V</code> The alarms +5V Supply rail A and +5V Supply rail B become critical when the measured voltage is under the threshold.
<code>neg15vThresh</code>	Threshold for -15V voltage supervisor. Default: <code>5V</code> The alarm -15V Supply rail becomes critical when the measured voltage is above the threshold.

Plug-in Notes

- This plug-in is based on `generic.js`.
- All MIB points are static.
- There are two types of alarms, global alarms for the whole unit and specific converter alarms. Global alarms are provided by:
 - MIB point `moreStatus` gives several different alarms and status
 - MIB point `sumAlrm` gives an overall Alarm
 - MIB points `pos15rail`, `pos5Arail`, `pos5Brail` and `neg15rail` give a voltage supervisor alarm
- All alarms can be considered as health monitoring.

Note: In accordance with the MIB, some entries are optional. Consequently, if data is not provided for a GSM alarm, the alarms status will remain UNKNOWN forever and no text will be associated. Regular expressions are used to parse data from SNMP varbind.

MIBs Used

The plug-in is currently compliant with the MIB called MITEQ-172138. We use the RFC1213 MIB point `sysUpTime` to detect device reboot and loss of communication.

NSU1 160061



The Miteq 1:N New Switchover Unit (NSU) is designed to provide improved reliability for advanced satellite communications systems. The NSU consists of a Control Unit, Switch Modules and frequency converters. The Control Unit monitors the status of up to twelve primary frequency converters and one backup frequency converter. When a fault is detected on a primary frequency converter, the defective converter is automatically placed into standby and the backup converter is placed on line in place of the defective converter using the Switch Modules. The frequency converters can be prioritized so that critical communication channels have access to the backup converter on a prioritized basis.

Switchover from a defective primary converter to the backup converter is achieved by connecting the converters to a switch matrix. The defective converter is replaced by physically removing its input/output signal lines and connecting them to the backup converter via the switch matrix. This ensures continuous operation while the fault is corrected, or allows for routine maintenance without disrupting signal transmission.

See the following for device support details:

- on page 173
- on page 175

Alarms

Alarm name	Type	MIB point	Further details
--- Converter alarms ---			
<i>cvalr</i> MIB point gives Local oscillator alarm and Power supply alarm.			
<i>mute</i> and <i>pol</i> are text alarms that only provide information			
<i>acvstat</i> MIB point gives informations for Redundancy Chain status alarms and serial link status converter alarm.			
Local Oscillator Alarm	Status/health	<i>cvalr</i>	Local Oscillator Alarm This alarm may occur if the specified converter is not installed. It also may happen if the converter cannot be selected with an SNMP set.
Power Supply Alarm	Status/health	<i>cvalr</i>	Power Supply Alarm This alarm may occur if the specified converter is not installed. It also may occur if the converter cannot be selected with an SNMP set.
Mute	Text/health	<i>mute</i>	Mute converter output for the converter selected by the most recent <i>cvse1</i> setting.
Polarization	Text/health	<i>pol</i>	Polarization setting for the converter selected by the most recent <i>cvse1</i> setting. Allowable settings: <ul style="list-style-type: none"> • 0 - N/A • 1 - None • 2 - Horizontal • 3 - Vertical
Serial Link Status converter	StatusText/health	<i>acvstat</i>	Converter serial link status indicator <ul style="list-style-type: none"> • 0 = No Fault - NSU-Converter Serial Link enabled and communicating • 1 = Fault - NSU-Converter Serial Link enabled and not communicating • 2 = No Fault - NSU-Converter Serial Link disabled • - = No Fault - Chain position inactive
Redundancy chain status	StatusText/health	<i>acvstat</i>	Redundancy chain status indicator <ul style="list-style-type: none"> • 0 = No Fault - chain position active • 1 = Fault -chain position active (Fault reported normally) • 2 = Fault - chain position active both contacts open • 3 = Fault - chain position active both contacts closed • - = chain position inactive disconnected from redundancy chain • + = chain position inactive connected to redundancy chain

Alarms (Continued)

Alarm name	Type	MIB point	Further details
--- Health monitoring alarms ---			
These alarms are created by generic.js			
Device Communication	Status/health	sysUpTime (RFC1213)	Raise a critical condition if the device stops responding to polling for a time period defined by pollinterval X retries.
Device Restart	Status/health	sysUpTime (RFC1213)	Raise a minor condition based on the value of sysUpTime read is smaller by at least 60 seconds compared to last reading. The value increase by 100 every second.
--- Status alarms ---			
Control Mode	Text/health	status	Control mode <ul style="list-style-type: none"> • 0 = Local control • 1 = Remote control
Redundancy Mode	Status/health	status	Redundancy mode <ul style="list-style-type: none"> • 0 = Manual • 1 = Automatic
Redundancy Chain Position	Text/health	status	Chain position in standby <ul style="list-style-type: none"> • 00 = Backup converter • 01 = Primary converter 1 • 12 = Primary converter 12
Polarization	Text/health	status	Polarization switch position <ul style="list-style-type: none"> • 0 = None • 1 = Horizontal • 2 = Vertical
Power Supply A	Status/health	status	Power Supply 'A' Alarm
Power Supply B	Status/health	status	Power Supply 'B' Alarm
Converter bus fault	Status/health	status	Converter bus fault
Converter Contact fault	Status/health	status	Converter Contact fault
Switch Module fault	Status/health	status	Switch Module fault
Switch Module Bus fault	Status/health	status	Switch Module Bus fault
write community	Status/health	writeCommunity	Check the write community defined in the device correspond to the configured one. This is important as the plug-in performs SNMP SET operations.

1. The switchover can monitor up to 12 converters + 1 backup.
2. This alarm can be set to UNKNOWN if cvalr data does not match the pattern ?abcdef.
3. This alarm can be set to UNKNOWN if converter cannot be selected with an SNMP set.

Configurable parameters

Parameter	Description
<code>AlarmPath</code>	Used to set the Alarm prefix. Default value: <code>PBI</code> Could be replaced by <code>IRD</code> to have legacy plug-ins tree look-like.
<code>pollInterval</code>	Poller interval in seconds. Overwrite the default interval of 20 seconds.
<code>retries</code>	If an SNMP request times out, this defines the number of retries to be performed. Default: <code>1</code>
<code>timeout</code>	Delay in seconds before declaring a timeout in the current SNMP request.
<code>uniqueID</code>	An extra identifier to be assigned to the plug-in to differentiate its alarms from the other plug-in of the same type. The <code>uniqueID</code> should be part of the URI.
<code>readCommunity</code>	SNMP read community string. Use for SNMP polling. Default value: <code>public</code>
<code>writeCommunity</code>	SNMP write community string. Use to set SNMP variable. Default value: <code>private</code>
<code>nbConverter</code>	Number of converter to monitor. By default, monitor all converters (12 + 1 backup)
<code>cvSelWaitTime</code>	Defines the number of milliseconds to wait after the converter selection. Default: <code>200 ms</code>

MIBs Used

The plug-in is currently compliant with the MIB MITEQ-160061. The RFC1213 MIB point `sysUpTime` is used to detect device reboot and loss of communication.

Motorola

Ordering information

Hardware	New in iControl version	GSM plug-in name	Order number
<code>APEX 1000</code>		SNMP – Motorola APEX	IC-SNMP-123
<code>CAP-1000</code>	4.30	SNMP – Motorola CAP-1000	IC-SNMP-134
<code>CP7600 (formerly Terayon CP7600)</code>			
<code>DM6400 CherryPicker (formerly Terayon DM6400)</code>		SNMP – Motorola DM 6400	IC-SNMP-175
<code>DSR-4410</code>		SNMP – Motorola DSR-4410	IC-SNMP-165
<code>DSR-4440</code>	6.02	SNMP – Motorola DSR-4440	IC-SNMP-238
<code>DSR-4460</code>	4.30	SNMP – Motorola DSR-4460	IC-SNMP-152

Ordering information (*Continued*)

Hardware	New in iControl version	GSM plug-in name	Order number
DSR-4500X		SNMP – Motorola DSR-4500X	IC-SNMP-022
DSR-4520X		SNMP – Motorola DSR-4520X	IC-SNMP-017
DSR-4530		SNMP – Motorola DSR-4530	IC-SNMP-166
DSR-4550	4.40	SNMP – Motorola DSR-4550	IC-SNMP-196
DSR-6000		SNMP – Motorola DSR-6000	IC-SNMP-167
DSR-6050		SNMP – Motorola DSR-6050	IC-SNMP-117
DSR-6100	4.30	SNMP – Motorola DSR-6100	IC-SNMP-131
DSR-6300		SNMP – Motorola DSR-6300	IC-SNMP-168
MBT 5000 System		SNMP – Motorola MBT5000	IC-SNMP-008
NE-Series AVC Network Encoder		SNMP – Motorola NE Encoder	IC-SNMP-160
NE-2000 Network Encryptor	4.10	SNMP – Motorola NE2000	IC-SNMP-160
SE-6000	4.11	SNMP – Motorola DSR-4530	IC-SNMP-084
OM-1000 Modulator		SNMP – Motorola DSR-4530	IC-SNMP-043
SE-Encoder		SNMP – Motorola DSR-4530	IC-SNMP-006
SE-2000 Encoder		SNMP – Motorola DSR-4530	IC-SNMP-006
SE-4000/4010		SNMP – Motorola DSR-4530	IC-SNMP-084
SE-5000/5010		SNMP – Motorola DSR-4530	IC-SNMP-084
SmartStream Encryptor/Modulator (SEM)		SNMP – Motorola DSR-4530	IC-SNMP-009
SmartStream Transport Multiplexer (TMX 2010)		SNMP – Motorola DSR-4530	IC-SNMP-007

CAP-1000

The Motorola CAP-1000 CherryPicker Application Platform is an advanced IP-centric multiplexer and encoder used to multiplex several SD/HD services encoded in MPEG-2 and MPEG-4 formats.

CP7600 (*formerly Terayon CP7600*)

Multichannel decoder.

DM6400 CherryPicker (*formerly Terayon DM6400*)

The DM6400 is part of the Motorola CherryPicker® line of digital video processing systems for networking, distributing and processing both standard definition (SD) and high definition (HD) services. It provides various digital video applications including grooming of custom channel lineups, rate shaping and statistical remultiplexing, and localized digital ad insertion.

DSR-4410

The Motorola DSR-4410 is a 1RU commercial satellite receiver that can output either NTSC or PAL video formats, automatically matching a programmer's video format. Variable front-end and bypass capabilities make it suited for network conversion from analog to digital. Full VBI reinsertion on lines 10 - 22 for SID/AMOL I & II and NABTS is standard on the DSR-4410, which is equipped with DVB-ASI input and output.

DSR-4440



This device is a Commercial Integrated Receiver/Decoder (IRD). It is a Multi-Format Digital Satellite Receiver for Cable Programmers and Operators.

See the following for device support details:

- on page 179
- on page 180
- on page 181

Health monitoring alarms

Alarm name	Type	MIB point	Polling or trap?	Further details
DC Board Status	Status	<code>dcBoardStatus</code> (DSR4440)	Poller	Indicates the status of DC board i.e. Active or Not Responding
Device Communication	Status	<code>sysUpTime</code> (RFC1213)	Poller	Device communication alarm set by receiving a successful/failed event in the poller
Device Restart	Status	<code>sysUpTime</code> (RFC1213)	Poller	Device power cycle alarm. Status determined comparing subsequent polling of the system up time variable
Flash Available	Status/Text	<code>flashAvail</code> (DSR4440)	Poller	Gives the size of the free Flash left, expressed in B(Bytes) that is available for the operating system, the threshold is defined based on the 20% of the total size of the flash
Flash Total	Text	<code>flashTotal</code> (DSR4440)	Poller	Gives the total size of the Flash expressed in B(Bytes) that is available for the operating system

Health monitoring alarms (*Continued*)

Alarm name	Type	MIB point	Polling or trap?	Further details
Memory Available	Status/Text	memAvail (DSR4440)	Poller	Gives the size of the free heap memory left, expressed in B(Bytes) that is available for the operating system, the threshold is defined based on the 20% of the total size of the memory
Memory Total	Text	memTotal (DSR4440)	Poller	Gives the total size of the heap memory expressed in B(Bytes) that is available for the operating system
System Uptime	Text	sysUpTime (RFC1213)	Poller	System up time alarm, this is a default health monitoring alarm when you use the generic.js to create a new custom driver

Service alarms

Alarm name	Type	MIB point	Polling or trap?	Further details
--- LED status alarms ---				
Authorized	Status/Text	authorizedLED	Fast poller	The Authorized LED is on (illuminated) when the Signal LED is on and the programmer has transmitted the access messages to allow the unit to decrypt the signal
Relay 1	Status/Text	relay1LED	Fast poller	The relay1 LED is on (illuminated) when relay1 is closed
Relay 2	Status/Text	relay2LED	Fast poller	The relay2 LED is on (illuminated) when relay2 is closed
Relay 3	Status/Text	relay3LED	Fast poller	The relay3 LED is on (illuminated) when relay3 is closed
Signal	Status	signalLED	Fast poller	The Signal LED is on (illuminated) when the unit recognizes the signal as a DigiCipher II signal
--- Signal lock alarms ---				
Primary Audio Lock	Status	primaryAudioLock	Fast poller	Verifies if the Primary Audio is locked
Secondary Audio Lock	Status	secondaryAudioLock	Fast poller	Verifies if the Secondary Audio is locked
video Lock	Status	videoLock	Fast poller	Verifies if the Video is locked

Service alarms (*Continued*)

Alarm name	Type	MIB point	Polling or trap?	Further details
--- Signal status alarms ---				
Acquisition State	Status/Text	<code>acquisitionState</code>	Fast poller	Displays the acquisition state for the active signal
Authorization State	Status/Text	<code>authorizationState</code>	Fast poller	Displays the authorization state for viewing the current signal (31 states)
Encryption Mode	Status/Text	<code>encryptionMode</code>	Fast poller	Displays the encryption mode of the current signal (5 modes)
Signal Quality	Status/Text	<code>signalQuality</code>	Fast poller	Displays the RF quality level of the current signal, the threshold is currently set to 30 which can also be passed as a parameter
Signal Power	Status/Text	<code>signalPower</code>	Fast poller	Displays the RF power level of the current signal, the threshold is currently set to -45 which can also be passed as a parameter
Signal to Noise Ratio	Status/Text	<code>ebNo</code>	Fast poller	Displays the signal to noise ratio of the current signal, the threshold is currently set to 10 which can also be passed as a parameter

Configurable parameters

Parameter	Description
<code>pollInterval</code>	Fast poller interval in seconds. Overwrite the default interval of 20 seconds.
<code>retries</code>	If an SNMP request times out, this defines the number of retries to be performed. Default is 1.
<code>timeout</code>	Delay in seconds before declaring a timeout in the current SNMP request.
<code>uniqueID</code>	An extra identifier to be assigned to the plug-in to differentiate its alarms from the other plug-in of the same type. The <code>uniqueID</code> should be part of the URI.
<code>readCommunity</code>	SNMP read community string. Use for SNMP polling.
<code>sqTrsh</code>	By setting this parameter we can define the Signal Quality threshold value.
<code>spTrsh</code>	By setting this parameter we can define the Signal Power threshold value.
<code>snrTrsh</code>	By setting this parameter we can define the Signal to Noise Ratio threshold value.
<code>trshLevelFla</code>	By setting this parameter we can define the threshold level for the available flash (a number from 0 to 1).
<code>trshLevelMem</code>	By setting this parameter we can define the threshold level for the available memory (a number from 0 to 1).

Configurable parameters (*Continued*)

Parameter	Description
<code>signalForcedSeverityText</code>	Text indicating the forced severity for service alarms. Possible values: CRITICAL, MAJOR, MINOR
<code>healthForcedSeverityText</code>	Text indicating the forced severity for health alarms. Possible values: CRITICAL, MAJOR, MINOR

DSR-4460

The DSR-4460 decodes an MPEG-2 or MPEG-4, HD or SD service and delivers superior video and audio performance via HD/SD-SDI output or analog/composite video output.

DSR-4500X

The Motorola DSR-4500X is an advanced commercial integrated receiver/decoder (IRD). Along with standard audio and video ports, this professional satellite receiver has connections to deliver data services, MPEG-2 transport streams and headend signaling.

DSR-4520X

DigiCipher® II integrated receiver/decoder (IRD) — digital satellite receiver.

DSR-4550

DigiCipher® II commercial integrated receiver/decoder (IRD) — digital satellite receiver for cable programmers and operators.

DSR-6100

DSR-6100 integrated receiver/decoder (IRD) — digital satellite receiver, decoder. The DSR-6100 is used to receive several HD services that are compressed using MPEG-2 and MPEG-4 encoding.

NE-2000 Network Encryptor

The Motorola NE2000 is a *Network Encryptor* used for MediaCipher encryption of MPEG-2 MPTS or SPTS.

SE-6000

The SE-6000 encoder, designed to meet future 1080p resolutions, accepts baseband SD and HD video, as well as pre-compressed MPEG-4 and MPEG-2 streams to act as both a high performance encoder and transcoder for satellite, cable and Internet Protocol Television (IPTV) applications.

OM-1000 Modulator

The Motorola OM-1000 is an MPEG-2/digital out-of-band multiplexer modulator used to transmit MPEG-2 data streams to cable terminals.

SE-2000 Encoder

The Motorola SE-2000 digital video encoder provides video compression technology in a compact chassis for cable headend, small broadcast and high bandwidth contribution applications. The SE-2000 accepts either analog composite or digital CCIR-601 video and performs MPEG-2 compression.

SE-1010/2000/2000IP

The Motorola SE-1010 digital video encoder provides video compression technology in a compact chassis for cable headend and small broadcast applications. The SE-1010 digital encoder accepts either analog composite or digital CCIR-601 video and performs MPEG-2 compression and stream splicing. The video compression data rate can be controlled through the Ethernet port via SNMP.

The Motorola SE-2000 digital video encoder provides video compression technology in a compact chassis for cable headend, small broadcast and high bandwidth contribution applications. The SE-2000 accepts either analog composite or digital CCIR-601 video and performs MPEG-2 compression.

SE-4000/4010

The SE-4000 SD video encoder delivers AVC compressed MPEG-4 content via existing MPEG-2 transport streams using IP or optional ASI. This encoder is the result of a partnership between Motorola and Modulus Video Inc.

SE-5000/5010

The SE-5000 HD video encoder delivers AVC compressed MPEG-4 content via existing MPEG-2 transport streams using IP or optional ASI. This encoder is the result of a partnership between Motorola and Modulus Video Inc.

SmartStream Encryptor/Modulator (SEM)

The Motorola SmartStream interactive digital cable system consists of an integrated set of high performance stream-processing elements for the deployment of advanced services like VOD and digital ad insertion. The SmartStream system adds functionality to existing digital cable systems with four product families: SmartStream Encryptor/Modulator (SEM), SmartStream Resource Manager (SRM), SmartStream Device Manager (SDM) and SmartStream Transcoder Multiplexer (TMX).

SmartStream Encryptor/Modulator provides the ability to encrypt a large number of services across 8 separate 64 or 256 QAM cable channels. The SEM supports both GigE and ASI transport technology, and can deliver hundreds of individual streams directly to subscribers. SEM encryption is part of Motorola's MediaCipher™ conditional access system.

SmartStream Transport Multiplexer (TMX 2010)

The SmartStream interactive digital cable system consists of an integrated set of high performance stream-processing elements necessary for the successful deployment of advanced services like VOD and digital ad insertion. The SmartStream system adds functionality to existing digital cable systems and adds four new product families: SmartStream Encryptor/Modulator (SEM), SmartStream Resource Manger (SRM), SmartStream Device Manager (SDM) and SmartStream Transcoder Multiplexer (TMX).

The TMX 2010 Transport Multiplexer provides MPEG-2 service multiplexing, grooming, video bitrate transcoding, video splicing, IP data encapsulation, and encoder management for digital broadcast, satellite and cable distribution.

Net Insight

Ordering information

Hardware	New in iControl version	GSM plug-in name	Order number
Nimbra680 Network Adaptor		SNMP – Net Insight Nimbra 6800	IC-SNMP-163

Nimbra680 Network Adaptor

The Nimbra 600 series of Media Switch Routers includes an array of carrier-class network switches with integrated media adapters and codecs for transport and processing of professional video, audio and data, with guaranteed quality of service regardless of network load or topology.

Network Electronics Inc.

Please see [Nevion \(Network Electronics Inc.\)](#), on page 185.

Nevion (Network Electronics Inc.)

Ordering information

Hardware	New in iControl version	GSM plug-in name	Order number
AAV-HD-DMUX-R HD-SDI Audio De-embedder (analog/digital audio)	6.03	SNMP – Nevion card aav hd-dmux	IC-SNMP-252
AAV-HD-XMUX-T/R HD-SDI Audio De-embedder (analog/digital audio)	6.03	SNMP – Nevion card aav hd-xmux	IC-SNMP-253
GYDA-SC Multi-frame System Controller		SNMP – Nevion GYDA	IC-SNMP-099
Multicon Nwork		SNMP – Nevion	IC-SNMP-164

Ordering information (*Continued*)

Hardware	New in iControl version	GSM plug-in name	Order number
--- Frames ---			
Nevion Frame	6.03		

Nevion Frame

See the following for device support details:

- on page 186
- on page 186
- on page 187

Note: The listed alarm names, paths, and URIs in the tables, below, follow a naming strategy based on several assumptions. For more details, see [Alarm Names, Paths, and URIs](#), on page 150.

Nevion Frame alarms

Alarm name	MIB point	Type	Alarm URI	Description
--- Signal alarms ---				
Integrity	monitorAlarmStatus	Status	\$(alarmPath)/Signal/integrity	Gives indication about the current signal type
--- Health monitoring alarms ---				
status_\$(elem)	voltageAlarmStatus	Status	\$(alarmPath)/Health Monitoring/voltage/status_Rack\$(RackNum)_Pos\$(PosNum)_Elem\$(ElemNum)	Shows the status of the voltage.
status_\$(elem)	temperatureAlarmStatus	Status	\$(alarmPath)/Health Monitoring/temperature/status_Rack\$(RackNum)_Pos\$(PosNum)_Elem\$(ElemNum)	Shows the status of the temperature.
status_\$(elem)	laserAlarmStatus	Status	\$(alarmPath)/Health Monitoring/laser/status_Rack\$(RackNum)_Pos\$(PosNum)_Elem\$(ElemNum)	Shows the status of the laser.
status_\$(elem)	optInputAlarmStatus	Status	\$(alarmPath)/Health Monitoring/optInput/status_Rack\$(RackNum)_Pos\$(PosNum)_Elem\$(ElemNum)	Shows the status of the optical input.

Neveion Frame alarms (*Continued*)

Alarm name	MIB point	Type	Alarm URI	Description
status_\$(group)	embedderAlarmStatus	Status	\$(alarmPath)/HealthMonitoring/embedder/\$(embedderType)/status_Rack\$(RackNum)_Pos\$(PosNum)_Elem\$(ElemNum)	Shows the status of the embedder. ¹
status_\$(elem)	audioBlockAlarmStatus	Status	\$(alarmPath)/HealthMonitoring/audioBlock/\$(AudioBlockType)/status_Rack\$(RackNum)_Pos\$(PosNum)_Elem\$(ElemNum)	Shows the status of the audioblock. ²

1. `embedderType` can be `embedder` or `deembeder`.
2. `AudioBlockType` can be `input`, `output` or `internal`.

Configurable parameters

Parameter name	Parameter object key	Description	Default value
Alarm path	alarmPath	Defines the base alarm path.	"SNMP/NEVION_FRAME/\$(HOST_IP)"/"
Poll interval	pollInterval	Poller interval in seconds.	
Retries	retries	If an SNMP request timeout, this defines the number of retries to be performed.	1
Timeout	timeout	Delay in seconds before declaring a timeout in the current SNMP request.	
Unique identifier	uniqueID	An extra identifier to be assigned to the plugin to differentiate its alarms from the other plugin of the same type. ¹	

1. The unique ID should be part of the URI.

MIBs used

MIB	MIB file name
NWORK-MIB	NWORK-MIB.mib

Alarm Names, Paths, and URIs

Each alarm URI should be unique. Each alarm related to a given card should have the same path.

To configure a spreadsheet, you must have the following information:

- rack and position—for all cards
- group (between 1 and 4)—for embedder sub-modules
- format type (aes, aa)—for audioblock sub-modules

Note: To ensure traps are handled correctly, URI format should not be changed.

Sub-Module Element Number

Most sub-modules alarms are created using the sub-element number. Their URI will contain *_Elem\$(ElemNum)*. For example:

```
snmp://NEVION_FRAME:10.12.170.126/voltageAlarmStatus_Rack0_Pos1_Elem0
```

Sub-modules with a Type

When a sub-module contains a type, the type appears in the path. There are currently only two sub-module types:

- Embedder can be *embedder* or *deembedder*
- AudioBlock can be *input*, *output* or *internal*

For example:

```
snmp://NEVION_FRAME:10.12.170.126/embedderAlarmStatus_Rack0_Pos1_Elem128
```

Sub-modules with a Group

Embedder sub-modules have a group property. When the alarm description includes a group (and not an embedder index), the group appears in the alarm name.

Note: In the URI, the element number remains (the element number cannot be replaced by the group since the traps do not provide any).

Example:

```
snmp://NEVION_FRAME:10.12.170.126/embedderAlarmStatus_Rack0_Pos1_Elem128
```

AAV-HD-DMUX-R HD-SDI Audio De-embedder (analog/digital audio)

The AAV-HD-DMUX is a highly integrated multi-rate audio de-embedding module in the Flashlink range, offering de-embedding of audio into AES or analog audio from a digital HD or SD serial video signal. The module is featured with optional optical receiver enabling easy integration into any optical video network.

See the following for device support details:

- on page 188
- on page 189
- on page 189

Alarms

Alarm name	Type	Polling or trap?	MIB point	Code to raise alarm	Description
Alarm count					
Status					

Alarms (Continued)

Alarm name	Type	Polling or trap?	MIB point	Code to raise alarm	Description
--- Health Monitoring > audioBlock > output ---					
status_0_aa					
status_1_aa					
status_2_aes					
status_3_aes					
status_4_aes					
status_5_aes					
--- Health Monitoring > embedder > deembedder ---					
status_128_group_1					
status_129_group_2					
status_130_group_3					
status_131_group_4					
--- Health Monitoring > embedder > embedder ---					
status_0_group_0					
status_1_group_1					
status_2_group_2					
status_3_group_3					
--- Health Monitoring > optInput ---					
status_0					
--- Health Monitoring > voltage ---					
status_0					
status_1					
status_2					
status_3					
status_4					
--- Monitor ---					
signalIntegrity_0					

Configurable parameters

Parameter name	Parameter object key	Description	Default value
Alarm Path	<code>alarmPath</code>	Defines the base alarm path.	"SNMP/NEVION_FRAME/(HOST_IP)/"
Poll Interval	<code>pollInterval</code>	Poller interval in seconds	
Retries	<code>retries</code>	Number of times to retry after a failed SNMP poll	1 retry
Timeout	<code>timeout</code>	Delay in seconds before declaring a timeout in the current SNMP request.	
Unique ID	<code>uniqueID</code>	An extra identifier to be assigned to the plugin to differentiate its alarms from the other plugin of the same type. The uniqueID should be part of uri.	

MIBs used

MIB	MIB file name
Nwork MIB	NWORK-MIB.mib

AAV-HD-XMUX-T/R HD-SDI Audio De-embedder (analog/digital audio)

The AAV-HD-XMUX is a multi-rate highly integrated audio embedding module in the Flashlink range, offering simultaneous embedding and de-embedding of audio from a digital HD or SD serial video signal.

See the following for device support details:

- on page 190
- on page 191
- on page 191

Alarms

Alarm name	Type	Polling or trap?	MIB point	Code to raise alarm	Description
Alarm count					
Status					
--- Health Monitoring > audioBlock > input ---					
status_0_aa					
status_1_aa					
status_2_aes					

Alarms (Continued)

Alarm name	Type	Polling or trap?	MIB point	Code to raise alarm	Description
status_3_aes					
--- Health Monitoring > audioBlock > output ---					
status_4_aes					
status_5_aes					
--- Health Monitoring > embedder > deembedder ---					
status_128_group_1					
status_129_group_2					
status_130_group_3					
status_131_group_4					
--- Health Monitoring > embedder > embedder ---					
status_0_group_0					
status_1_group_1					
status_2_group_2					
status_3_group_3					
--- Health Monitoring > optInput ---					
status_0					
--- Health Monitoring > voltage ---					
status_0					
status_1					
status_2					
status_3					
status_4					
--- Monitor ---					
signalIntegrity_0					

Configurable parameters

Parameter name	Parameter object key	Description	Default value
Alarm Path	alarmPath	Defines the base alarm path.	"SNMP/NEVION_FRAME/\${HOST_IP}/"
Poll Interval	pollInterval	Poller interval in seconds	
Retries	retries	Number of times to retry after a failed SNMP poll	1 retry

Configurable parameters (*Continued*)

Parameter name	Parameter object key	Description	Default value
Timeout	<code>timeout</code>	Delay in seconds before declaring a timeout in the current SNMP request.	
Unique ID	<code>uniqueID</code>	An extra identifier to be assigned to the plugin to differentiate its alarms from the other plugin of the same type. The uniqueID should be part of uri.	

MIBs used

MIB	MIB file name
Nwork MIB	NWORK-MIB.mib

GYDA-SC Multi-frame System Controller

The GYDA System Controller is an advanced control and monitoring card for the Network Electronics flashlink® system. The card can control and monitor up to 8 flashlink frames (79 modules). It has a standard 10BASE-T Ethernet port, and supports SNMP. The controller module has four GPI inputs and a GPI open collector output.

Multicon Nwork

Multicon is the second generation system controller from Nevion replacing existing GYDA-SC, ETH-CON and Syscon products. Multicon is based on an open and distributed architecture and provides one platform to monitor and control both Flashlink and VikinX products. These features and a powerful third party plug-in interface allow for full control of the entire video transport chain.

Novelsat NS2000 Demodulator

Introduction

The NovelSat NS2000 Demodulator supports up to 425Mbps using 70Msym/sec transmission. The NS2000 offers:

- Lowest bandwidth consumption – lowering satellite bandwidth usage by 30% to 60%
- Highest throughput – using existing bandwidth
- Highest data rate – raising maximum transmitted data rate to 425 Mbps
- Smallest dish/HPA size – using the same data rate
- Larger footprint – using the same data rates at remote locations

Product Information

The NovelSat NS2000 is a satellite demodulator that supports all common modulation methods: DVB-S, DVB-S2, DVB-SNG, and NovelSat NS4. Features include signal processing and error correction for enhanced impairment resistance. It offers dual channel support and output for any two stream types – 2XASI, 2XGigabit and ASI & Gigabit.

The NS2000 supports high data rates, reaching up to 425Mbps using 70Msps when using the NovelSat NS4 waveform. It supports transmission of one carrier over a 72MHz transponder.

The NS2000 dual channel option diverts a stream to one of two available interfaces, or any combination thereof – enabling transmission quality that is solely dependent upon interface content. Dual channel operation also enables the combination of Ethernet Stream and ASI, for migration to Ethernet streaming.

Alarms

Novelsat NS2000 Demodulator Alarms

Device Type	Alarm Group	Alarm Uri	Alarm Name	Alarm Type	Level	Include In Path Health
NS2000	Health	{baseuri}communicationStatus	Communication	Status	Device	True
NS2000	HW	{baseuri}nsCommonSystemHwConfigInternalClockType	Internal Clock Type	Text	Device	True
NS2000	HW	{baseuri}nsCommonSystemHwConfigMacAddress	Management MAC	Text	Device	True
NS2000	HW	{baseuri}nsCommonSystemHwConfigHardwareVersion	HW Version	Text	Device	True
NS2000	HW	{baseuri}nsCommonSystemHwConfigSerialNumber	Serial Number	Text	Device	True
NS2000	HW	{baseuri}nsCommonSystemHwConfigProductType	Tuner Product Type	Text	Device	True
NS2000	HW	{baseuri}nsDemodMonitorSystem10MhzClkSource	10MHz Clock Source	Text	Device	True
NS2000	Temperature	{baseuri}nsDemodMonitorSystemFPGATmp	FPGA	Text	Device	True
NS2000	Temperature	{baseuri}nsDemodMonitorSystemBoardTmp	System Board	Text	Device	True
NS2000	SW	{baseuri}nsCommonSystemSwVersionDb	Database Version	Text	Device	True
NS2000	SW	{baseuri}nsCommonSystemSwVersionFirmware	Firmware Version	Text	Device	True
NS2000	SW	{baseuri}nsCommonSystemSwVersionFs	FS Version	Text	Device	True
NS2000	SW	{baseuri}nsCommonSystemSwVersionOs	OS Version	Text	Device	True
NS2000	SW	{baseuri}nsMibVersion	MIB Version	Text	Device	True
NS2000	Interface 1	{baseuri}nsDemodMonitorInterfaceName1	Name	Text	Device	True
NS2000	Interface 1	{baseuri}nsDemodMonitorInterfaceRate1	Rate	Text	Device	True
NS2000	Interface 1	{baseuri}nsDemodMonitorInterfaceSource1	Source	Text	Device	True
NS2000	Interface 2	{baseuri}nsDemodMonitorInterfaceName2	Name	Text	Device	True
NS2000	Interface 2	{baseuri}nsDemodMonitorInterfaceRate2	Rate	Text	Device	True
NS2000	Interface 2	{baseuri}nsDemodMonitorInterfaceSource2	Source	Text	Device	True
NS2000	Channel 1	{baseuri}nsDemodConfigChIsiTo1	ISI Range End	Text	None	True
NS2000	Channel 1	{baseuri}nsDemodConfigChIsiFrom1	ISI Range Start	Text	None	True
NS2000	Channel 1	{baseuri}nsDemodMonitorLineChannelDataRate1	Data Rate	Text	None	True

Novelsat NS2000 Demodulator Alarms

Device Type	Alarm Group	Alarm Uri	Alarm Name	Alarm Type	Level	Include In Path Health
NS2000	Channel 1	{baseuri}nsDemodMonitorLineChannelFEC1	FEC Mode	Text	None	True
NS2000	Channel 1	{baseuri}nsDemodMonitorLineChannelFramesErr1	FER error frames	Text	None	True
NS2000	Channel 1	{baseuri}nsDemodMonitorLineChannelFramesErrRate1	FER error frames rate	Text	None	True
NS2000	Channel 1	{baseuri}nsDemodMonitorLineChannelFrames1	FER frames	Text	None	True
NS2000	Channel 1	{baseuri}nsDemodMonitorLineChannelFrameSize1	Frame Size	Text	None	True
NS2000	Channel 1	{baseuri}nsDemodMonitorLineChannelLinkMargin1	Link Margin	Text	None	True
NS2000	Channel 1	{baseuri}nsDemodMonitorLineChannelLockStatus1	Lock Status	Text	None	True
NS2000	Channel 1	{baseuri}nsDemodMonitorLineChannelModulation1	Modulation Mode	Text	None	True
NS2000	Channel 1	{baseuri}nsDemodMonitorLineChannelPilot1	Pilot Mode	Text	None	True
NS2000	Channel 1	{baseuri}nsDemodMonitorLineChannelSNR1	SNR	Text	None	True
NS2000	Channel 2	{baseuri}nsDemodConfigChIsiTo2	ISI Range End	Text	None	True
NS2000	Channel 2	{baseuri}nsDemodConfigChIsiFrom2	ISI Range Start	Text	None	True
NS2000	Channel 2	{baseuri}nsDemodMonitorLineChannelDataRate2	Data Rate	Text	None	True
NS2000	Channel 2	{baseuri}nsDemodMonitorLineChannelFEC2	FEC Mode	Text	None	True
NS2000	Channel 2	{baseuri}nsDemodMonitorLineChannelFramesErr2	FER error frames	Text	None	True
NS2000	Channel 2	{baseuri}nsDemodMonitorLineChannelFramesErrRate2	FER error frames rate	Text	None	True
NS2000	Channel 2	{baseuri}nsDemodMonitorLineChannelFrames2	FER frames	Text	None	True
NS2000	Channel 2	{baseuri}nsDemodMonitorLineChannelFrameSize2	Frame Size	Text	None	True
NS2000	Channel 2	{baseuri}nsDemodMonitorLineChannelLinkMargin2	Link Margin	Text	None	True

Supported Devices

Novelsat NS2000 Demodulator Alarms

Device Type	Alarm Group	Alarm Uri	Alarm Name	Alarm Type	Level	Include In Path Health
NS2000	Channel 2	{baseuri}nsDemodMonitorLineChannelLockStatus2	Lock Status	Text	None	True
NS2000	Channel 2	{baseuri}nsDemodMonitorLineChannelModulation2	Modulation Mode	Text	None	True
NS2000	Channel 2	{baseuri}nsDemodMonitorLineChannelPilot2	Pilot Mode	Text	None	True
NS2000	Channel 2	{baseuri}nsDemodMonitorLineChannelSNR2	SNR	Text	None	True
NS2000	ASI 1	{baseuri}nsDemodConfigInterfaceASIDataInvert1	Data Invert	Text	None	True
NS2000	ASI 1	{baseuri}nsDemodConfigInterfaceASIDataRate1	Data Rate	Text	None	True
NS2000	ASI 1	{baseuri}nsDemodConfigInterfaceASIDataRateAccuracy1	Data Rate Accuracy	Text	None	True
NS2000	ASI 1	{baseuri}nsDemodConfigInterfaceASIDataRateMode1	Data Rate Mode	Text	None	True
NS2000	ASI 1	{baseuri}nsDemodConfigInterfaceASISource1	Source	Text	None	True
NS2000	ASI 2	{baseuri}nsDemodConfigInterfaceASIDataInvert2	Data Invert	Text	None	True
NS2000	ASI 2	{baseuri}nsDemodConfigInterfaceASIDataRate2	Data Rate	Text	None	True
NS2000	ASI 2	{baseuri}nsDemodConfigInterfaceASIDataRateAccuracy2	Data Rate Accuracy	Text	None	True
NS2000	ASI 2	{baseuri}nsDemodConfigInterfaceASIDataRateMode2	Data Rate Mode	Text	None	True
NS2000	ASI 2	{baseuri}nsDemodConfigInterfaceASISource2	Source	Text	None	True
NS2000	Ethernet 1	{baseuri}nsDemodConfigInterfaceEthernetAutoNegotiation1	Auto-Negotiation	Text	None	True
NS2000	Ethernet 1	{baseuri}nsDemodConfigInterfaceEthernetDuplex1	Duplex	Text	None	True
NS2000	Ethernet 1	{baseuri}nsDemodConfigInterfaceEthernetEncapsulation1	Encapsulation	Text	None	True
NS2000	Ethernet 1	{baseuri}nsDemodConfigInterfaceEthernetPid1	PID (32-8191)	Text	None	True
NS2000	Ethernet 1	{baseuri}nsDemodConfigInterfaceEthernetSource1	Source	Text	None	True
NS2000	Ethernet 1	{baseuri}nsDemodConfigInterfaceEthernetSpeed1	Speed	Text	None	True
NS2000	Ethernet 2	{baseuri}nsDemodConfigInterfaceEthernetAutoNegotiation2	Auto-Negotiation	Text	None	True
NS2000	Ethernet 2	{baseuri}nsDemodConfigInterfaceEthernetDuplex2	Duplex	Text	None	True

Novelsat NS2000 Demodulator Alarms

Device Type	Alarm Group	Alarm Uri	Alarm Name	Alarm Type	Level	Include In Path Health
NS2000	Ethernet 2	{baseuri}nsDemodConfigInterfaceEthernetEncapsulation2	Encapsulation	Text	None	True
NS2000	Ethernet 2	{baseuri}nsDemodConfigInterfaceEthernetPid2	PID	Text	None	True
NS2000	Ethernet 2	{baseuri}nsDemodConfigInterfaceEthernetSource2	Source	Text	None	True
NS2000	Ethernet 2	{baseuri}nsDemodConfigInterfaceEthernetSpeed2	Speed	Text	None	True
NS2000	Line	{baseuri}nsDemodConfigLineAcmMargin	ACM Margin	Text	None	True
NS2000	Line	{baseuri}nsDemodConfigLineAcmMode	ACM Mode	Text	None	True
NS2000	Line	{baseuri}nsDemodConfigLineAcmServerAddress	ACM Server Address	Text	None	True
NS2000	Line	{baseuri}nsDemodConfigLineAutoCcmMode	Auto CCM Mode	Text	None	True
NS2000	Line	{baseuri}nsDemodConfigLineDualChState	Dual Channel Mode	Text	None	True
NS2000	Line	{baseuri}nsDemodConfigLineRFFreq	Frequency	Text	None	True
NS2000	Line	{baseuri}nsDemodConfigLineGoldSeq	Golden Sequence	Text	None	True
NS2000	Line	{baseuri}nsDemodConfigLineInputLevelMode	Input Level Mode	Text	None	True
NS2000	Line	{baseuri}nsDemodConfigLineLNBControl	LNB Mode	Text	None	True
NS2000	Line	{baseuri}nsDemodConfigLineLOFreq	LO Frequency	Text	None	True
NS2000	Line	{baseuri}nsDemodConfigLineMode	Mode	Text	None	True
NS2000	Line	{baseuri}nsDemodConfigLineNoneLinearMode	None Linear Mode	Text	None	True
NS2000	Line	{baseuri}nsDemodConfigLineRollOff	Rolloff Factor	Text	None	True
NS2000	Line	{baseuri}nsDemodConfigLineSymbolRate	Symbol Rate	Text	None	True
NS2000	Line	{baseuri}nsDemodMonitorLineCompositePower	Composite Power	Text	None	True
NS2000	Line	{baseuri}nsDemodMonitorLineDataRateCh1	Data Rate Channel 1	Text	None	True
NS2000	Line	{baseuri}nsDemodMonitorLineDataRateCh2	Data Rate Channel 2	Text	None	True
NS2000	Line	{baseuri}nsDemodMonitorLineFERErrorFrames	FER error frames	Text	None	True
NS2000	Line	{baseuri}nsDemodMonitorLineFERErrorFramesRate	FER error frames rate	Text	None	True
NS2000	Line	{baseuri}nsDemodMonitorLineFERFrames	FER Frames	Text	None	True
NS2000	Line	{baseuri}nsDemodMonitorLineRFFreq	Frequency	Text	None	True
NS2000	Line	{baseuri}nsDemodMonitorLineFrequencyOffset	Frequency Offset	Text	None	True
NS2000	Line	{baseuri}nsDemodMonitorLineLinkMargin	Link Margin	Text	None	True
NS2000	Line	{baseuri}nsDemodMonitorLineMode	Mode	Text	None	True
NS2000	Line	{baseuri}nsDemodMonitorLineSNR	Pilot SNR	Text	None	True

Novelsat NS2000 Demodulator Alarms

Device Type	Alarm Group	Alarm Uri	Alarm Name	Alarm Type	Level	Include In Path Health
NS2000	Line	{baseuri}nsDemodMonitorLinePrbsErrorBitsRate	PRBS bit Error rate	Text	None	True
NS2000	Line	{baseuri}nsDemodMonitorLinePrbsDataBytes	PRBS Data Rate	Text	None	True
NS2000	Line	{baseuri}nsDemodMonitorLinePrbsErrorBits	PRBS Error Bits	Text	None	True
NS2000	Line	{baseuri}nsDemodMonitorLinePrbsSource	PRBS Source	Text	None	True
NS2000	Line	{baseuri}nsDemodMonitorLineRollOff	Rolloff Factor	Text	None	True
NS2000	Line	{baseuri}nsDemodMonitorLineSignalPower	Signal	Text	None	True
NS2000	Line	{baseuri}nsDemodMonitorLineState	State	Text	None	True
NS2000	Line	{baseuri}nsDemodMonitorLineSymbolRate	Symbol Rate	Text	None	True
NS2000	Line	{baseuri}nsDemodMonitorLineSymbolRateOffset	Symbol-rate Offset	Text	None	True

NTT Electronics

Supported NTT Electronics devices include:

- NTT Electronics HVD 6100, on page 178
- NTT Electronics HVD 9100, on page 186

NTT Electronics HVD 6100

Introduction

The HVD6100 is an AVC/H.264 and MPEG-2 HDTV/SDTV Integrated Receiver Decoder (IRD).



HVD6100 is an IRD that combines decoder functionality with support for AVC/H.264 HDTV, 4:2:2 chroma with a DVB-S2 demodulator.

The decoder function supports multi-format (AVC/H.264 and MPEG-2, 4:2:2/4:2:0 chroma and HDTV/SDTV). It comes equipped with a variety of features such as HDTV to SDTV down-conversion.

The demodulator function supports DVB-S2, DVB-DSNG and DVB-S formats for high-performance satellite transmissions. For its demodulation method, it supports 16APSK and 32APSK as well as QPSK and 8PSK, which are more efficient transmission formats.

Alarms

The following table lists all available alarms provided by the driver.

- NTT Electronics HVD 6100 Driver Alarms

MIB node name	Type	Description	Alarm URI	OID
GSM Alarm Name	Status/Text/Both	Read/Write		
hvd6100SysDescr	Text			Machine Name
hvd6100SysMibVersion	Text			Version of this MIB file
hvd6100SysUpTime	Text			Number of seconds since the last reboot
hvd6100SysVersion	Text			Version of device
hvd6100SysSerialNumber	Text			Serial Number
Decoder alarms				
hvd6100DecProgSource		read/write		Sets the program source
hvd6100DecProgNumMode		read/write		Sets how to select a program number
hvd6100DecProgNumInput		read/write		Sets a program number
hvd6100DecProgTable		read only		Received program table
hvd6100DecSdiAsi1		read/write		Select the output mode of SDI/ASI 1
hvd6100DecSdiAsi2		read/write		Select the output mode of SDI/ASII 2
hvd6100DecSdiAsi3		read/write		Select the output mode of SDI/ASI 3
hvd6100DecAsiOutSource		read/write		Sets the ASI output source
hvd6100DecVideoDownCon		read/write		Sets the type of down conversion
hvd6100DecVideoAspectCon		read/write		Sets the type of aspect conversion
hvd6100DecDSS2LnbFreq		read/write		Sets the LNB frequency (MHz)
hvd6100DecDSS2SateFreq		read/write		Sets the satellite frequency (KHz)
hvd6100DecDSS2SymRate		read/write		Sets the symbol rate (KBaud)
hvd6100DecTsolpOutSource		read/write		Sets the IP output source
hvd6100DecPFECMode		read/write		Sets the FEC mode
hvd6100StatTsnAsiRate		read only		ASI TS total bit rate (bps) (0 appear when no stream input is available)
hvd6100StatTsnTunerRate		read only		Tuner TS total bit rate (bps) (0 appear when no stream input is available)
hvd6100StatVideoFormat		read only		Video format

Supported Devices

- NTT Electronics HVD 6100 Driver Alarms

MIB node name	Type	Description	Alarm URI	OID
GSM Alarm Name	Status/Text/Both	Read/Write		
hvd6100StatVideoRate		read only		Video rate (bps) (0 appear when no stream input is available)
hvd6100StatVideoType		read only		Video stream type
hvd6100StatVideoProfile		read only		Video profile
hvd6100StatAudio1Mode		read only		Audio1 Mode
hvd6100StatAudio1Rate		read only		Audio1 rate (bps) (0 appear when no stream input is available)
hvd6100StatAudio2Mode		read only		Audio2 Mode
hvd6100StatAudio2Rate		read only		Audio2 rate (bps) (0 appear when no stream input is available)
hvd6100StatIpOutTSIn		read only		The input status of IP Out source
hvd6100StatIdTS		read only		TS ID (0 appear when no stream input is available)
hvd6100StatIdProgramNo		read only		Program No. (0 appear when no stream input is available)
hvd6100StatDevError		read only		The status of the decoder error
hvd6100StatDevWarning		read only		The status of the decoder warning
hvd6100StatDevAsi		read only		The status of ASI input
hvd6100StatDevTuner		read only		The status of Tuner input
hvd6100StatDevTsoip		read only		The status of TS over IP input
hvd6100StatVideoInput		read only		The status of video input
hvd6100StatAudio1Input		read only		The status of audio1 input
hvd6100StatAudio2Input		read only		The status of audio2 input
hvd6100StatGenLockInput		read only		The status of genlock
Health alarms				
hvd6100StatTemperature1		read only		The equipment temperature1 (Celsius)
hvd6100StatTemperature2		read only		The equipment temperature2 (Celsius)
hvd6100StatFan1Err ...				
hvd6100StatFan4Err				

• NTT Electronics HVD 6100 Driver Alarms

MIB node name	Type	Description	Alarm URI	OID
GSM Alarm Name	Status/Text/Both	Read/Write		
	read only		The status of FAN1 to FAN4	
hvd6100AlarmsTable		read only		Alarm table
..hvd6100AlarmIndex		read only		Index of the alarm table (1..64)
..hvd6100AlarmProbableCause		read only		Event code
..hvd6100AlarmType		read only		Alarm type
..hvd6100AlarmSpecificProblem		read only		It is a text string that describes hvd6100AlarmProbableCause more in detail
..hvd6100AlarmPerceivedSeverity		read only		Alarm severity
..hvd6100AlarmTime		read only		Time that alarm was generated

NTT Electronics HVD 6100 Alarms by Group

NTT Electronics HVD 6100 Alarms by Group

Alarm Group	Alarm URI	Alarm Name	Alarm Type	Level	Include in Path Header
Health	{baseuri}communicationStatus	Communication	Status	Device	True
HW	{baseuri}hvd6100StatTemperature1	Temp1	Text	Device	True
HW	{baseuri}hvd6100StatTemperature2	Temp2	Text	None	True
HW	{baseuri}hvd6100SysSerialNumber	Serial Number	Text	Device	True
HW	{baseuri}hvd6100SysVersion	Version	Text	None	True
HW	{baseuri}hvd6100StatFan1Err	Fan1 Error	Both	None	True
HW	{baseuri}hvd6100StatFan2Err	Fan2 Error	Both	None	True
HW	{baseuri}hvd6100StatFan3Err	Fan3 Error	Both	None	True
HW	{baseuri}hvd6100StatFan4Err	Fan4 Error	Both	None	True
HW	{baseuri}hvd6100StatTemp1Err	Temperature 1 Error	Both	None	True
HW	{baseuri}hvd6100StatTemp2Err	Temperature 2 Error	Both	None	True
ID	{baseuri}hvd6100StatIdAudio1	Audio 1 PID	Text	None	True
ID	{baseuri}hvd6100StatIdAudio2	Audio 2 PID	Text	None	True
ID	{baseuri}hvd6100StatIdAudio3	Audio 3 PID	Text	None	True
ID	{baseuri}hvd6100StatIdAudio4	Audio 4 PID	Text	None	True
ID	{baseuri}hvd6100StatIdECM	ECM PID	Text	None	True
ID	{baseuri}hvd6100StatIdPCR	PCR PID	Text	None	True
ID	{baseuri}hvd6100StatIdPMT	PMT PID	Text	None	True
ID	{baseuri}hvd6100StatIdProgramNo	Program Number	Text	None	True
ID	{baseuri}hvd6100StatIdSDT	SDT PID	Text	None	True
ID	{baseuri}hvd6100StatIdTS	TS ID	Text	None	True
ID	{baseuri}hvd6100StatIdVideo	Video PID	Text	None	True
Program	{baseuri}hvd6100DecProgSource	Source	Text	None	True
Program	{baseuri}hvd6100DecProgNumMode	Mode	Text	None	True
Program	{baseuri}hvd6100DecProgNumInput	Input	Both	None	True
Program	{baseuri}hvd6100DecProgNumSdtSet	STD Set	Both	None	True
Program	{baseuri}hvd6100DecProgNumSdtPid	STD PID	Both	None	True
Service	{baseuri}hvd6100StatServiceProvider	Provider Name	Text	None	True
Service	{baseuri}hvd6100StatServiceName	Service Name	Text	None	True
Service	{baseuri}hvd6100StatServiceType	Service Type	Text	None	True

NTT Electronics HVD 6100 Alarms by Group

Alarm Group	Alarm URI	Alarm Name	Alarm Type	Level	Include in Path Header
DVB	{baseuri}hvd6100DecDSS2DiSEqC	DiSEqC	Text	None	True
DVB	{baseuri}hvd6100DecDSS2FecFrType	FEC Frame Type	Text	None	True
DVB	{baseuri}hvd6100DecDSS2FecRMode	FEC Rate	Text	None	True
DVB	{baseuri}hvd6100DecDSS2InputPort	Input Port	Text	None	True
DVB	{baseuri}hvd6100DecDSS2IsiControl	ISI Control	Text	None	True
DVB	{baseuri}hvd6100DecDSS2Isi	ISI	Text	None	True
DVB	{baseuri}hvd6100DecDSS2Lnb22Khz	LNB 22 KHz	Text	None	True
DVB	{baseuri}hvd6100DecDSS2LnbFreq	LNB Frequency	Text	None	True
DVB	{baseuri}hvd6100DecDSS2LnbVol	LNB Voltage	Text	None	True
DVB	{baseuri}hvd6100DecDSS2DeMode	Mode	Text	None	True
DVB	{baseuri}hvd6100DecDSS2FreOffLimit	Search Range	Text	None	True
DVB	{baseuri}hvd6100DecDSS2Pilots	Pilots	Text	None	True
DVB	{baseuri}hvd6100DecDSS2Pls	PLS Signature	Text	None	True
DVB	{baseuri}hvd6100DecDSS2ROFactor	RollOff	Text	None	True
DVB	{baseuri}hvd6100DecDSS2CodeMode	S2 Coding	Text	None	True
DVB	{baseuri}hvd6100DecDSS2SateFreq	Satellite Frequency	Text	None	True
DVB	{baseuri}hvd6100DecDSS2SymRate	Symbol Rate	Text	None	True
Tuner	{baseuri}hvd6100StatTunerDvbS2CN	DVB-S2 C/N	Text	None	True
Tuner	{baseuri}hvd6100StatTunerDvbSCN	DVB-S C/N	Text	None	True
Tuner	{baseuri}hvd6100StatTunerFECRate	FEC Rate	Text	None	True
Tuner	{baseuri}hvd6100StatTunerFrameSize	Frame Size	Text	None	True
Tuner	{baseuri}hvd6100StatTunerLinkMargin	Link Margin	Text	None	True
Tuner	{baseuri}hvd6100StatTunerModulation	Modulation	Text	None	True
Tuner	{baseuri}hvd6100StatTunerPilotSymbol	Pilot Symbol	Text	None	True
Tuner	{baseuri}hvd6100StatTunerSignalLevel	Signal Level	Text	None	True
Tuner	{baseuri}hvd6100StatTunerSpectralSense	Spectral Sense	Text	None	True
Tuner	{baseuri}hvd6100StatTunerStandard	Standard	Text	None	True
Tuner	{baseuri}hvd6100StatTunerViterbiBER	Viterbi BER	Text	None	True
TS Input	{baseuri}hvd6100StatTsInAsiRate	ASI Rate	Text	None	True
TS Input	{baseuri}hvd6100StatTsInTunerRate	Tuner Rate	Text	None	True
TS over IP	{baseuri}hvd6100DecPFECAction	FEC Action	Text	None	True

NTT Electronics HVD 6100 Alarms by Group

Alarm Group	Alarm URI	Alarm Name	Alarm Type	Level	Include in Path Header
TS over IP	{baseuri}hvd6100DecPFECAlign	FEC Alignment	Text	None	True
TS over IP	{baseuri}hvd6100DecTsolpOutEnable	IP Out Enable	Text	None	True
TS over IP	{baseuri}hvd6100DecPFECMode	FEC Mode	Text	None	True
TS over IP	{baseuri}hvd6100DecTsolpOutPro	Protocol	Text	None	True
TS over IP	{baseuri}hvd6100DecTsolpOutSource	Source	Text	None	True
TS over IP	{baseuri}hvd6100DecTsolpOutTTL	Time To Live (TTL)	Text	None	True
TS over IP	{baseuri}hvd6100DecTsolpOutTPPU	TS Packets Per UDP	Text	None	True
TS over IP	{baseuri}hvd6100DecTsolpOutCast	TX Cast Mode	Text	None	True
TS over IP	{baseuri}hvd6100DecTsolpOutIPv4	TX IPv4 Address	Text	None	True
TS over IP	{baseuri}hvd6100DecTsolpOutPort	TX Port Number	Text	None	True
TS over IP	{baseuri}hvd6100DecTsolpOutTOS	Type Of Service	Text	None	True
TS over IP	{baseuri}hvd6100DecTsolpSIPv4	IPv4 Address	Text	None	True
TS over IP	{baseuri}hvd6100DecTsolpSGIpAddr	IPv4 Gateway	Text	None	True
TS over IP	{baseuri}hvd6100DecTsolpSSubMask	IPv4 Mask	Text	None	True
TS over IP	{baseuri}hvd6100DecTsolpSLinkSD	Link Speed	Text	None	True
TS over IP	{baseuri}hvd6100DecTsolpSMacAddr	MAC Address	Text	None	True
TS over IP	{baseuri}hvd6100DecTsolpInCast	RX Cast Mode	Text	None	True
TS over IP	{baseuri}hvd6100DecTsolpInIPv4	RX IPv4 Address	Text	None	True
TS over IP	{baseuri}hvd6100DecTsolpInPort	RX Port Number	Text	None	True
Decoder	{baseuri}hvd6100StatDevAsi	ASI Input	Both	None	True
Decoder	{baseuri}hvd6100StatAudio1Input	Audio1 Input	Both	None	True
Decoder	{baseuri}hvd6100StatAudio2Input	Audio2 Input	Text	None	True
Decoder	{baseuri}hvd6100StatAudio3Input	Audio3 Input	Text	None	True
Decoder	{baseuri}hvd6100StatAudio4Input	Audio4 Input	Text	None	True
Decoder	{baseuri}hvd6100StatCIS1Status	CI Slot 1	Text	None	True
Decoder	{baseuri}hvd6100StatCIS2Status	CI Slot 2	Text	None	True
Decoder	{baseuri}hvd6100StatDevError	Error	Both	None	True
Decoder	{baseuri}hvd6100StatDevTsoip	TS Over IP Input	Text	None	True
Decoder	{baseuri}hvd6100StatDevTuner	Tuner Input	Text	None	True
Decoder	{baseuri}hvd6100StatVideoInput	Bvideo Input	Text	None	True
Decoder	{baseuri}hvd6100StatDevWarning	Warning	Both	None	True

NTT Electronics HVD 6100 Alarms by Group

Alarm Group	Alarm URI	Alarm Name	Alarm Type	Level	Include in Path Header
BISS	{baseuri}hvd6100DecBissMode	Mode	Text	None	True
BISS	{baseuri}hvd6100DecBissESWSelect	Encryption SW Mode	Text	None	True
Genlock	{baseuri}hvd6100DecGlockADelay	Audio Delay	Text	None	True
Genlock	{baseuri}hvd6100DecGlockMode	FS Mode	Text	None	True
Genlock	{baseuri}hvd6100DecGlockHPhase	Video H Phase	Text	None	True
Genlock	{baseuri}hvd6100DecGlockVPhase	Video V Phase	Text	None	True
Genlock	{baseuri}hvd6100StatGenLock	Status	Both	None	True
Output	{baseuri}hvd6100DecAsiOutSource	ASI Output Source	Text	None	True
Output	{baseuri}hvd6100DecSdiAsi1	SDI/ASI 1 Mode	Text	None	True
Output	{baseuri}hvd6100DecSdiAsi2	SDI/ASI 2 Mode	Text	None	True
Output	{baseuri}hvd6100DecSdiAsi3	SDI/ASI 3 Mode	Text	None	True
Video	{baseuri}hvd6100DecVideoAspectCon	Aspect Conversion	Text	None	True
Video	{baseuri}hvd6100DecVideoCVBSPede	CVBS Pedestal	Text	None	True
Video	{baseuri}hvd6100DecVideoDownCon	Down Conversion	Text	None	True
Video	{baseuri}hvd6100DecVFFreeze	Freeze	Text	None	True
Video	{baseuri}hvd6100DecVFGreenScreen	Green Screen	Text	None	True
Video	{baseuri}hvd6100DecVideoPanHori	Horizontal Position	Text	None	True
Video	{baseuri}hvd6100DecVideoYPbPrRGB	YPbPr RGB Output Screen	Text	None	True
Video	{baseuri}hvd6100StatVideoChroma	Chroma	Both	None	True
Video	{baseuri}hvd6100StatVideoFormat	Format	Text	None	True
Video	{baseuri}hvd6100StatVideoProfile	Profile	Text	None	True
Video	{baseuri}hvd6100StatVideoRate	Rate	Text	None	True
Video	{baseuri}hvd6100StatVideoType	Stream Type	Text	None	True
Audio1	{baseuri}hvd6100StatAudio1Mode	Mode	Both	None	True
Audio1	{baseuri}hvd6100StatAudio1Output	Output	Both	None	True
Audio1	{baseuri}hvd6100StatAudio1Rate	Rate	Both	None	True
Audio1	{baseuri}hvd6100StatAudio1SampleBit	Sample Bit	Both	None	True
Audio2	{baseuri}hvd6100StatAudio2Mode	Mode	Both	None	True
Audio2	{baseuri}hvd6100StatAudio2Output	Output	Both	None	True
Audio2	{baseuri}hvd6100StatAudio2Rate	Rate	Both	None	True

Supported Devices

NTT Electronics HVD 6100 Alarms by Group

Alarm Group	Alarm URI	Alarm Name	Alarm Type	Level	Include in Path Header
Audio2	{baseuri}hvd6100StatAudio2SampleBit	Sample Bit	Both	None	True
Audio3	{baseuri}hvd6100StatAudio3Mode	Mode	Both	None	True
Audio3	{baseuri}hvd6100StatAudio3Output	Output	Both	None	True
Audio3	{baseuri}hvd6100StatAudio3Rate	Rate	Both	None	True
Audio3	{baseuri}hvd6100StatAudio3SampleBit	Sample Bit	Both	None	True
Audio4	{baseuri}hvd6100StatAudio4Mode	Mode	Both	None	True
Audio4	{baseuri}hvd6100StatAudio4Output	Output	Both	None	True
Audio4	{baseuri}hvd6100StatAudio4Rate	Rate	Both	None	True
Audio4	{baseuri}hvd6100StatAudio4SampleBit	Sample Bit	Both	None	True

NTT Electronics HVD 9100



The NTT Electronics HVD 9100 is a High 4:2:2 Profile HDTV/SDTV encoder/decoder. It supports both MPEG-2 and AVC/H.264 video compression formats.

NTT Electronics has employed an in-house ASIC solution for a fast boot up time of 15 seconds. With a reduced restarting time after changing parameters, the codec is designed for the workplaces of broadcasters, which required a quick set-up and continuous broadcasting.

Alarms

GSM Alarm Name	Type: Read/Write Access	Description
hvd9100AlarmIndex	read-only	Index of alarm table
hvd9100AlarmPerceivedSeverity	read-only	Alarm severity
hvd9100AlarmProbableCause	read-only	Event code
hvd9100AlarmSpecificProblem	read-only	Error message
hvd9100AlarmsTable		
hvd9100AlarmTime	read-only	Time that event was generated
hvd9100AlarmType	read-only	Alarm type
hvd9100DecBissESW	read-write	Sets the biss ESW
hvd9100DecBissESWSelect	read-write	Select the ESW mode
hvd9100DecBissID	read-write	Sets the biss ActiveID
hvd9100DecBissMode	read-write	Select the biss mode
hvd9100DecBissSW	read-write	Sets the biss SW
hvd9100DecInput	read-write	Select the input
hvd9100DecIpCastMode	read-write	Select the cast mode
hvd9100DecIpFec	read-write	Select the FEC
hvd9100DecIpPacket	read-write	Select the packet mode
hvd9100DecIpStreamIpAddress	read-write	
Decision of the stream IP address. Format is as follows.		
hvd9100DecIpStreamPort	read-write	Sets a stream port number
hvd9100DecProgInput		Sets a program number
hvd9100DecProgMode	read-write	Sets how to select a program number
hvd9100StatAncillaryInput	read-only	State of ancillary of decoder
hvd9100StatAudio1Input	read-only	State of audio1 input
hvd9100StatAudio2Input	read-only	State of audio2 input
hvd9100StatDCVoltErr	read-only	State of DC voltage1
hvd9100StatDecode	read-only	Status of operation of decoder
hvd9100StatFan1Err	read-only	State of fan1

Supported Devices

GSM Alarm Name	Type: Read/Write Access	Description
hvd9100StatFan2Err	read-only	State of fan2
hvd9100StatGenLockInput	read-only	State of Gen lock
hvd9100StatTempErr	read-only	State of temperature
hvd9100StatVideoInput	read-only	State of video input
hvd9100SysDescr	read-only	Product name
hvd9100SysMibVersion	read-only	Version of this MIB file
hvd9100SysUpTime	read-only	Number of seconds since the last reboot
hvd9100SysVersion	read-only	Version of device

NTT Electronics HVD 9100 Driver Alarms

NTT Electronics HVD 9100 Alarms by Groups

Alarm Group	Alarm UIRI	Alarm Name	Alarm Type	Level	Include in Path Health
Overall	[that.buildBaseVirtualAlarmUriLocalPlugin()]Overall	Overall Health	Status	None	True
Health	{baseuri}communicationStatus	Communication	Status	Device	True
HW	{baseuri}hvd9100StatTemperature1	Temp1	Text	Device	True
HW	{baseuri}hvd9100StatTemperature2	Temp2	Text	None	True
HW	{baseuri}hvd9100StatDCVoltage	DC Voltage	Text	None	True
HW	{baseuri}hvd9100SysVersion	Version	Text	None	True
HW	{baseuri}hvd9100StatFan1Err	Fan1 Error	Both	None	True
HW	{baseuri}hvd9100StatFan2Err	Fan2 Error	Both	None	True
HW	{baseuri}hvd9100StatDCVoltErr	DC Voltage Error	Both	None	True
HW	{baseuri}hvd9100StatTempErr	Temperature Error	Both	None	True
ID	{baseuri}hvd9100StatIdAnc1	Ancillary 1 PID	Text	None	True
ID	{baseuri}hvd9100StatIdAnc2	Ancillary 2 PID	Text	None	True
ID	{baseuri}hvd9100StatIdAnc3	Ancillary 3 PID	Text	None	True
ID	{baseuri}hvd9100StatIdAudio1	Audio 1 PID	Text	None	True
ID	{baseuri}hvd9100StatIdAudio2	Audio 2 PID	Text	None	True
ID	{baseuri}hvd9100StatIdAudio3	Audio 3 PID	Text	None	True
ID	{baseuri}hvd9100StatIdAudio4	Audio 4 PID	Text	None	True
ID	{baseuri}hvd9100StatIdECM	ECM PID	Text	None	True
ID	{baseuri}hvd9100StatIdPCR	PCR PID	Text	None	True
ID	{baseuri}hvd9100StatIdPMT	PMT PID	Text	None	True
ID	{baseuri}hvd9100StatIdProgramNo	Program Number	Text	None	True
ID	{baseuri}hvd9100StatIdTS	TS ID	Text	None	True
ID	{baseuri}hvd9100StatIdVideo	Video PID	Text	None	True
Decoder	{baseuri}hvd9100StatDevWarning	Warning	Both	None	True
Decoder	{baseuri}hvd9100StatDevAlarm	Alarm	Both	None	True
Decoder	{baseuri}hvd9100StatAudio1Input	Audio1 Input	Text	None	True
Decoder	{baseuri}hvd9100StatAudio2Input	Audio2 Input	Text	None	True
Decoder	{baseuri}hvd9100StatAudio3Input	Audio3 Input	Text	None	True
Decoder	{baseuri}hvd9100StatAudio4Input	Audio4 Input	Text	None	True
Decoder	{baseuri}hvd9100StatDecode	Status	Text	None	True

Supported Devices

NTT Electronics HVD 9100 Alarms by Groups

Alarm Group	Alarm UIRI	Alarm Name	Alarm Type	Level	Include in Path Health
Decoder	{baseuri}hvd9100StatVideoInput	Video Input	Text	None	True
Program	{baseuri}hvd9100DecInput	Source	Text	None	True
Program	{baseuri}hvd9100DecProgMode	Mode	Text	None	True
Program	{baseuri}hvd9100DecProgInput	Input	Both	None	True
Program	{baseuri}hvd9100DecPsiSdt	STD Set	Both	None	True
Program	{baseuri}hvd9100DecPsiSdtPid	STD PID	Both	None	True
TS over IP	{baseuri}hvd9100DecIPSmoothBufMode	Buffer Mode	Text	None	True
TS over IP	{baseuri}hvd9100DecIpSmoothBufSize	Buffer Size	Text	None	True
TS over IP	{baseuri}hvd9100DecIpCastMode	Cast Mode	Text	None	True
TS over IP	{baseuri}hvd9100DecIpCompatibility	Compatibility TS Padding	Text	None	True
TS over IP	{baseuri}hvd9100DecIpFec	FEC	Text	None	True
TS over IP	{baseuri}hvd9100DecIpStreamIpAddress	IPV4 Address	Text	None	True
TS over IP	{baseuri}hvd9100DecStreamIpv6Address	IPV6 Address	Text	None	True
TS over IP	{baseuri}hvd9100DecIpVersion	IP Version	Text	None	True
TS over IP	{baseuri}hvd9100DecIpPacketReorderSize	Packet Reorder Size	Text	None	True
TS over IP	{baseuri}hvd9100DecIpStreamPort	Port Number	Text	None	True
TS over IP	{baseuri}hvd9100DecIpPacket	Protocol	Text	None	True
TS over IP	{baseuri}hvd9100DecIpRestoreLogMode	Restore Log Mode	Text	None	True
TS over IP	{baseuri}hvd9100DecIpRtpPtOverwriteFec	RTP Type of FEC Packets	Text	None	True
TS over IP	{baseuri}hvd9100DecIpRtpPtOverwriteTs	RTP Type of TS Packets	Text	None	True
TS over IP	{baseuri}hvd9100DecIpRtpPtOverwriteMode	RTP PT Overwrite Mode	Text	None	True
TS over IP	{baseuri}hvd9100DecIpCrypt	Stream Crypt	Text	None	True
TS over IP	{baseuri}hvd9100DecIpT	Training Time	Text	None	True
TS over IP	{baseuri}hvd9100DecIpTSDelayTime	TS Delay Time	Text	None	True
TS over IP	{baseuri}hvd9100DecTsSize	TS Packet Size	Text	None	True
TS over IP	{baseuri}hvd9100DecTsType	TS Packet Type	Text	None	True
Video	{baseuri}hvd9100DecVideoType	Type	Text	None	True
Video	{baseuri}hvd9100DecVideoMode	Mode	Text	None	True
Video	{baseuri}hvd9100DecVideoGreen	Green Screen	Text	None	True
Video	{baseuri}hvd9100DecVideoFreeze	Freeze	Text	None	True

NTT Electronics HVD 9100 Alarms by Groups

Alarm Group	Alarm UIRI	Alarm Name	Alarm Type	Level	Include in Path Health
Video	{baseuri}hvd9100DecVideoDelay	Video Delay	Text	None	True
Video	{baseuri}hvd9100StatVideoChroma	Chroma	Text	None	True
Video	{baseuri}hvd9100StatVideoFormat	Format	Text	None	True
Video	{baseuri}hvd9100StatVideoProfile	Profile	Text	None	True
Video	{baseuri}hvd9100StatVideoProfileLevel	Profile Level	Text	None	True
Video	{baseuri}hvd9100StatVideoRate	Rate	Text	None	True
Video	{baseuri}hvd9100StatVideoType	Stream Type	Text	None	True
BISS	{baseuri}hvd9100DecBissMode	Mode	Text	None	True
BISS	{baseuri}hvd9100DecBissESWSelect	Encryption SW Mode	Text	None	True
Genlock	{baseuri}hvd9100DecGlockADelay	Audio Delay	Text	None	True
Genlock	{baseuri}hvd9100DecGlockMode	FS Mode	Text	None	True
Genlock	{baseuri}hvd9100DecGlockHPhase	Video H Phase	Text	None	True
Genlock	{baseuri}hvd9100DecGlockVPhase	Video V Phase	Text	None	True
Genlock	{baseuri}hvd9100StatGenLock	Status	Both	None	True
Service	{baseuri}hvd9100StatServiceProgramNo	Program Number	Text	None	True
Service	{baseuri}hvd9100StatServiceProviderName	Program Name	Text	None	True
Service	{baseuri}hvd9100StatServiceServiceName	Service Name	Text	None	True
Service	{baseuri}hvd9100StatServiceServiceType	Service Type	Text	None	True
TS Input	{baseuri}hvd9100StatTsRate	ASI Rate	Text	None	True
TS over IP	{baseuri}hvd9100DecDSS2SymRate	Symbol Rate	Text	None	True
TS over IP	{baseuri}hvd9100DecBissMode	Mode	Text	None	True
TS over IP	{baseuri}hvd9100DecBissESWSelect	Encryption SW Mode	Text	None	True
Audio1	{baseuri}hvd9100StatAudio1Mode	Mode	Both	None	True
Audio1	{baseuri}hvd9100StatAudio1Output	Output	Both	None	True
Audio1	{baseuri}hvd9100StatAudio1Rate	Rate	Both	None	True
Audio1	{baseuri}hvd9100StatAudio1SampleBit	Sample Bit	Both	None	True
Audio2	{baseuri}hvd9100StatAudio2Mode	Mode	Both	None	True
Audio2	{baseuri}hvd9100StatAudio2Output	Output	Both	None	True
Audio2	{baseuri}hvd9100StatAudio2Rate	Rate	Both	None	True
Audio2	{baseuri}hvd9100StatAudio2SampleBit	Sample Bit	Both	None	True
Audio3	{baseuri}hvd9100StatAudio3Mode	Mode	Both	None	True

Supported Devices

NTT Electronics HVD 9100 Alarms by Groups

Alarm Group	Alarm UIRI	Alarm Name	Alarm Type	Level	Include in Path Health
Audio3	{baseuri}hvd9100StatAudio3Output	Output	Both	None	True
Audio3	{baseuri}hvd9100StatAudio3Rate	Rate	Both	None	True
Audio3	{baseuri}hvd9100StatAudio3SampleBit	Sample Bit	Both	None	True
Audio4	{baseuri}hvd9100StatAudio4Mode	Mode	Both	None	True
Audio4	{baseuri}hvd9100StatAudio4Output	Output	Both	None	True
Audio4	{baseuri}hvd9100StatAudio4Rate	Rate	Both	None	True
Audio4	{baseuri}hvd9100StatAudio4SampleBit	Sample Bit	Both	None	True

PESA Switching Systems (QuStream Group)

Ordering information

Hardware	New in iControl version	GSM plug-in name	Order number
Cheetah, Tiger, Jaguar, Cougar, Ocelot, Bobcat, and TDM3000 (SNM 35V3)		SNMP – PESA SNM 35V3	IC-SNMP-086

Cheetah, Tiger, Jaguar, Cougar, Ocelot, Bobcat, and TDM3000 (SNM 35V3)

HD digital routing switchers and multi-rate routers, serial digital routing switchers, analog routing switchers, and large scale Time Division Multiplex (TDM) audio switchers.

Phoenix Broadband Technologies (PBT)

Ordering information

Hardware	New in iControl version	GSM plug-in name	Order number
ContactAgent GPI		GPI PBT ContactAgent	IC-SNMP-056

ContactAgent GPI

The Phoenix Broadband Technologies PBT-CA1 is a general purpose status monitoring agent intended to monitor and control equipment that has “contact closure” interface points.

The PBT-CA1 has a general purpose I/O interface consisting of 8 digital inputs that can be monitored for external contact closures, 2 controllable relay contact outputs that can be used

to remotely control external equipment, and an RS-485 port that can be programmed to interface with proprietary serial interfaces.

Pinnacle Data Systems Inc. (PDSI)

Ordering information

Hardware	New in iControl version	GSM plug-in name	Order number
DS130		SNMP – Pinnacle	IC-SNMP-003

DS130

The DS130 data storage system is an entry-level, carrier-grade data backup solution that provides a single, direct-cable connection to each fixed, internal peripheral.

Pro Broadband, Inc. (PBI)

Ordering information

Hardware	New in iControl version	GSM plug-in name	Order number
DCH-4000P MPEG-2 SD IRD and Processor	6.02	SNMP – PBI DCH4000P Receiver	IC-SNMP-240

DCH-4000P MPEG-2 SD IRD and Processor



The DCH-4000P is a professional IRD with a variety of input combinations (including DVB over ASI, IP, QPSK, QAM, COFDM and DS3) and output (CVBS, SDI, ASI, DS3 and IP). An appropriate IP port equipped as an option supports DVB over IP applications. LAN control and monitoring are achieved with TCP/IP, SNMP and HDMS.

See the following for device support details:

- on page 194
- on page 196

Health monitoring alarms

Alarm name	Type	MIB point	Further details
--- Health monitoring alarms ---			
Device Communication	Status/health	sysUpTime (RFC1213)	Raise a critical condition if the device stops responding to polling for a time period defined by pollinterval X retries.
Device Restart	Status/health	sysUpTime (RFC1213)	Raise a critical condition if the device stops responding to polling for a time period defined by pollinterval X retries.

--- Input DVBS alarms ---

All the following are elements related to signal input with type tuner DVBS. All those elements are displayed in a subfolder named 'Input DVBS2.'

Lock	Status/Signal	tunerLock	Tuner Lock
Packet Length	Text/Signal	tunerPacketLen	packet length: 188 or 204
Total Bitrate	Text/Signal	tunerTotalBitrate	total bit Rate size: from 0 to 100Mbps
Valid Bitrate	Text/Signal	tunerValidBitrate	valid Bit rate: from 0 to 100Mbps
Quality	Text/Signal	tunerQuality	tuner quality signal monitoring
Strength	Text/Signal	tunerStrength	tuner signal strength
Signal BER	Text/Signal	tunerBER	tuner signal BER
Carrier noise	Text/Signal	tunerCN	tuner carrier noise
Eb/No	Text/Signal	tunerEbNo	tuner Eb/No
Lnb Frequency	Text/Signal	lnbFrequency	LNB frequency
sat Frequency	Text/Signal	satFrequency	Tuner frequency or centre_frequency for the transmission expressed in MHz, its value range: from 950 MHz to 2150 MHz
symbol Rate	Text/Signal	symbolRate	Tuner symbol rate in symbols per second,its value range: from 0kb/s to 45000kb/s
lnb Voltage	Text/Signal	lnbVoltage	Tuner power, Option: 0v,13v,18v
lnb 22KHz	Text/Signal	lnb22KHz	Tuner 22 KHz, option: off or on
Tuner type selected	Text/Signal	typeSel	tuner type

--- Input ASI alarms ---

All the following are elements related to signal input with type ASI. All those elements are displayed in a subfolder named 'Input ASI.'

Lock	Status/Signal	asiLock	ASI Lock
Packet Length	Text/Signal	asiPacketLen	packet length: 188 or 204
Total Bitrate	Text/Signal	asiTotalBitrate	total bit Rate size: from 0 to 100Mbps
Valid Bitrate	Text/Signal	asiValidBitrate	valid Bit rate: from 0 to 100Mbps

Health monitoring alarms (Continued)

Alarm name	Type	MIB point	Further details
------------	------	-----------	-----------------

--- Input IP alarms ---

All the following are elements related to signal input with type IP. All those elements are displayed in a subfolder named 'Input IP':

Lock	Status/Signal	<code>ethernetInLock</code>	Ethernet Lock
Packet Length	Text/Signal	<code>ethernetInPacketLen</code>	packet length: 188 or 204
Total Bitrate	Text/Signal	<code>ethernetInTotalBitrate</code>	total bit Rate size: from 0 to 100Mbps
linkStatus	StatusText/Signal	<code>linkStatus</code>	Ethernet link status (none, 10M, 100M). Status is set to NORMAL if link is 10M or 100M. If none, or unknown, status is set to CRITICAL .

--- Output ASI alarms: Out 1 ---

All the following are elements related to signal output with type ASI. There are two output ports. The following is the set of alarms for Port 1. Subfolder: Output ASI/Out 1

Source	Text/Signal	<code>sourceSel1</code>	select source, qpsk:0, asi:1, ds3:2
Package Length	Text/Signal	<code>packageLength1</code>	package length, 188 or 204

--- Output ASI alarms: Out 2 ---

All the following are elements related to signal output with type ASI. There are two output ports. The following is the set of alarms for Port 2. Subfolder: Output ASI/Out 2

Source	Text/Signal	<code>sourceSel2</code>	select source, qpsk:0, asi:1, ds3:2
Package Length	Text/Signal	<code>packageLength2</code>	package length, 188 or 204

--- Output IP alarms ---

There is only one IP output port.

IP address	Text/Signal	<code>ipAddress</code>	Ethernet output ip address
Stream UDP port	Text/Signal	<code>streamUDPPort</code>	ethernet output stream UDP port
Multicast IP address	Text/Signal	<code>multicastIPAddress</code>	ethernet output multicast IP address
TS packets per UDP	Text/Signal	<code>tsPacketPerUDP</code>	ethernet output TS packets per UDP
TTL	Text/Signal	<code>ttl</code>	ethernet output ttl
External board netmask	Text/Signal	<code>sourceNetmask</code>	External board netmask
External board gateway	Text/Signal	<code>sourceGateway</code>	External board gateway
External board mac	Text/Signal	<code>sourceMac</code>	External board mac
Multicast port	Text/Signal	<code>multiUDPPort</code>	Multicast port
Protocol	Text/Signal	<code>protocol</code>	Protocol : udp or trp
Type service	Text/Signal	<code>typeService</code>	normal, min delay, max throughput, max reliability, min monetary cost

Health monitoring alarms (*Continued*)

Alarm name	Type	MIB point	Further details
Source	StatusText/Signal	<code>source</code>	Text can be asi, tuner, ds3, CI. Status is NORMAL if source value correspond to the parameter "inputType". If source is unknown or does not match, status is set to CRITICAL.
Mode	Text/Signal	<code>mode</code>	DVB, IPTV
Max Channel	Text/Signal	<code>maxChannel</code>	when mode is IPTV, hardware sustain max channel
Current MaxChannel	Text/Signal	<code>curMaxChannel</code>	when mode is IPTV, device can output channel number most currently
Channel Input	Text/Signal	<code>channelInput</code>	when mode is IPTV, input channel number currently
MulticastValues	Text/Signal	<code>multicastValues</code>	when mode is IPTV, the value of multicast
Gateway Mac address	Text/Signal	<code>gatewayMac</code>	gateway mac address
HighTargetMac	Text/Signal	<code>highTargetMac</code>	when mode is IPTV, it denote all multicast channel's target mac, only save high 32bit, one channel occupy 4 bytes
LowTargetMac	Text/Signal	<code>lowTargetMac</code>	when mode is IPTV, it denote all multicast channel's target mac, only save target mac's low 16bit, one channel occupy 4 bytes, latter 2 bytes is effective
TargetMac4Dvb	Text/Signal	<code>targetMac4Dvb</code>	when mode is DVB, the target mac address

Configurable parameters

Parameter	Description
AlarmPath	Used to set the Alarm prefix. Default value: <code>PBI</code> Could be replaced by <code>IRD</code> so as to have legacy plug-ins tree look-like.
pollInterval	Poller interval in seconds. Overwrite the default interval of 20 seconds.
retries	If an SNMP request timeout, this defines the number of retries to be performed. Default value: <code>1</code> .
timeout	Delay in seconds before declaring a timeout in the current SNMP request.
uniqueID	An extra identifier to be assigned to the plug-in to differentiate its alarms from the other plugin of the same type. The <code>uniqueID</code> should be part of uri.
readCommunity	SNMP read community string. Use for SNMP polling. Default value: <code>public</code>
inputType	Defines the signal input type. Value can be <code>DVB_S</code> , <code>ASI</code> or <code>IP</code> Default value: <code>DVB_S</code>
outputType	Defines the signal output type. Value can be <code>ASI</code> or <code>IP</code> Default value: <code>IP</code>

QLogic

Ordering information

Hardware	New in iControl version	GSM plug-in name	Order number
SAN Fiber Channel Switches		SNMP – QLogic SAN Fiber Channel Switches	IC-SNMP-202

SAN Fiber Channel Switches

The QLogic SAN Fiber Channel Switch family comprise a series of Fibre Channel (FC) protocol switches for use as the backbone of storage area networks (SANs).

Quest Controls Inc.

Ordering information

Hardware	New in iControl version	GSM plug-in name	Order number
TELSEC RM/WM-Series Controller		SNMP – Quest Telsec WM	IC-SNMP-149

TELSEC RM/WM-Series Controller

The TELSEC RM/WM-series controller is used to monitor/control environmental and access control functions as well as equipment alarming at a remote site.

RGB Networks

Ordering information

Hardware	New in iControl version	GSM plug-in name	Order number
BNP Broadcast Network Processor	4.40	SNMP – RGB Networks Broadcast Network Processor	IC-SNMP-191
MMC Modular Media Converter	4.40	SNMP – RGB Networks Modular Media Converter	IC-SNMP-192
SEP 48 Simulcast Edge Processor		SNMP – RGB SEP 48	IC-SNMP-095

BNP Broadcast Network Processor

The BNP broadcast network processor family of devices perform video processing including grooming, statistical multiplexing, transrating, digital program insertion, emergency alert and operator messaging services, as well as digital graphic overlays.

MMC Modular Media Converter

The MMC modular media converter performs high-density ASI-to-Gigabit Ethernet conversion, thereby facilitating the transition to Gigabit networks.

SEP 48 Simulcast Edge Processor

The SEP 48 Simulcast Edge Processor performs MPEG decoding, NTSC modulation and upconversion of multiple video streams for digital simulcast applications.

Riedel

Ordering information

Hardware	New in iControl version	GSM plug-in name	Order number
Artist Intercom System		SNMP – Riedel Artist	IC-SNMP-088

Artist Intercom System

Artist is a matrix platform for intercom and the distribution of analogue and digital audio and TCP/IP data signals. The system consists of a fibre-based network backbone providing a distributed masterless system architecture for live audio and intercom applications.

Rohde & Schwarz

Ordering information

Hardware	New in iControl version	GSM plug-in name	Order number
AEM100 Emission Multiplexer	4.40	SNMP – Rohde and Schwarz Aem100	IC-SNMP-187
Exciter	4.40	SNMP – Rohde and Schwarz Exciter	IC-SNMP-186

AEM100 Emission Multiplexer

The AEM100 multiplexer enables network operators to expand existing ATSC transmitter networks for ATSC Mobile DTV.

Exciter

Exciter is a multistandard TV exciter, able to process digital and analog signals when operating in ATSC mode.

Ross Video Production Technology

Ordering information

Hardware	New in iControl version	GSM plug-in name	Order number
openGear Frame and Modules	4.40	SNMP – Ross OpenGear	IC-SNMP-184

openGear Frame and Modules

openGear Frames, and their modules, are industry standard openGear terminal equipment.

Samsung

Ordering information

Hardware	New in iControl version	GSM plug-in name	Order number
ME-B Series Commercial Display Monitors		SNMP – Samsung ME-B Series Monitor	IC-DR-015

ME-B Series Commercial Display Monitors

Samsung's ME-B series of display monitors delivers a high-resolution display and integrated TV tuner for content versatility and control through RS232C and RJ45 ports.

Screen Subtitling Systems Ltd.

Ordering information

Hardware	New in iControl version	GSM plug-in name	Order number
Polistream Subtitling Product Family		SNMP – Screen Subtitling	IC-SNMP-137

Polistream Subtitling Product Family

The *Polistream* family of products offers a full range of subtitling solutions including transmission and transcoding, branding and timeshifting, and monitoring and logging. The Polistream product range simplifies the control and management of subtitle and caption delivery by employing modular software and flexible processing platforms. Polistream manages the transmission for any mix of DVB, Teletext, closed caption, Imitext and open subtitles as well as other data including graphics.

SeaChange

Ordering information

Hardware	New in iControl version	GSM plug-in name	Order number
MediaServer 1200 Multi-Channel SD/HD Video Server		SNMP – Seachange MSV 1200 Media Server	IC-SNMP-203
SPOT Ad Insertion System		SNMP – Seachange SPOT	IC-SNMP-150

SPOT Ad Insertion System

The SeaChange Spot System is an automated solution for reliable advertising insertion at the lowest operational expense and highest quality. Using spots loaded through an encoding station and schedules provided from an ad traffic and billing system, the Spot System completes every task necessary for fulfillment without operator intervention.

BML Servers

Please see [XOR Media \(formerly SeaChange \[Broadcast Division\]\)](#), on page 179.

MCL Codec Servers

Please see [XOR Media \(formerly SeaChange \[Broadcast Division\]\)](#), on page 179.

VOD Server

Please see [XOR Media \(formerly SeaChange \[Broadcast Division\]\)](#), on page 179.

Sencore

Ordering information

Hardware	New in iControl version	GSM plug-in name	Order number
MRD 3187B Receiver/Decoder		SNMP – Sencore MRD3187B	IC-SNMP-118
MRD 4400 Modular Receiver/Decoder	6.03	SNMP – Sencore MRD4400	IC-SNMP-266

MRD 3187B Receiver/Decoder

The MRD 3187B is a modular, configurable receiver/decoder solution, consisting of a system base with a software package. The MRD 3187B supports applications by combining dual-channel processing capability with MPEG2, H.264, 4:2:0, 4:2:2, SD, and HD video decoding. The MRD 3187B also supports features such as DVB-CI and SCTE35/104 messaging support.

MRD 4400 Modular Receiver/Decoder



The MRD 4400 Receiver/ Decoder is an integrated receiver/decoder for distribution and monitoring applications. The 4400 supports decoding of SD or HD video, encoded as either MPEG-2 or H.264, as well as up to four audio services.

See the following for device support details:

- on page 201
- on page 202
- on page 203

Alarms

Alarm name	Type	Description	URI format
Communication Status	Device	Indicates communication status with the device	{baseuri}commStatus
Device Reboot	Device	Indicates reboot status of the device	{baseuri}powerCycle
FanError	Device	Fan error	{baseuri}fantempFanError
Temperature	Device	Temperature readings in celsius	{baseuri}fantempTemp
Temperature error	Device	Temperature error	{baseuri}fantempTempError
MPEG IP address	Service	mpeg Receiver Group Ip	{baseuri}mpegIpRecvGroupIp
MPEG port number	Service	mpeg Receiver Destination Port	{baseuri}mpegIpRecvDestPort
audio channel 1 PID	Service	audio channel 1 decoder Pid	{baseuri}auddecPid1
audio channel 2 PID		audio channel 2 decoder Pid	{baseuri}auddecPid2
decoder Tuning Mode	Service	decoder Tuning Mode 1. unknown(1) 2. pidLocked(2) 3. priority(3) 4. auto(4) 5. noPsi(5)	{baseuri}decoderTuningMode
decoder Pcr Pid	Service	decoder Pcr Pid	{baseuri}decoderPcrPid
decoder Video Pid	Service	decoder Video Pid	{baseuri}decoderVideoPid
VSB Channel	Service	VSB RF Channel number	{baseuri}VSBChannel
Audio channel 1 Pid Not Present	Service	Audio channel 1 Pid Not Present	{baseuri}selectedaudioAudioPidNotPresentCond1
Audio channel 2 Pid Not Present	Service	Audio channel 2 Pid Not Present	{baseuri}selectedaudioAudioPidNotPresentCond2

Supported Devices

Alarms (Continued)

Alarm name	Type	Description	URI format
Audio channel 1 Not Decoding	Service	Audio channel 1 Not Decoding	{baseuri}audiosrvNotDecodingCond1
Audio channel 2 Not Decoding	Service	Audio channel 2 Not Decoding	{baseuri}audiosrvNotDecodingCond2
unit Input Error	Service	unit Input Error	{baseuri}unitInputError
No Services Detected	Service	No Services Detected	{baseuri}NoServicesDetected
Pcr Pid Not Present	Service	Pcr Pid Not Present	{baseuri}selectedservicePcrPidNotPresentCond
Service Not Found	Service	Service Not Found	{baseuri}serviceLockServiceNotFoundCond
Pcr Pid Not Present	Service	Pcr Pid Not Present	{baseuri}selectedservicePcrPidNotPresentCond
unit Alias	Device	unit Alias. Name given by the customer to this unit.	{baseuri}unitAlias
unit Model	Device	unit Model (MRD4400)	{baseuri}unitModel
unit Serial Num	Device	unit Serial Num ex(7022396 R21)	{baseuri}unitSerialNum
unitVersion	Device	firmware version	{baseuri}unitVersion
video Decode	Device	video Decoder error	{baseuri}videoDecode
Video format error	Service	Video format error	{baseuri}videooutputAutoVideoFormatCond
Video Pid Not Present	Service	Video Pid Not Present	{baseuri}selectedserviceVideoPidNotPresentCond
vsbin Rf Lock Lost Cond	Service	Rf Lock Lost	{baseuri}vsbinRfLockLostCond
vsbin Ts Sync Loss Cond	Service	Sync Loss	{baseuri}vsbinTsSyncLossCond

Configurable parameters

Parameter name	Parameter object key	Description	Default value
Alarm Path	alarmPath	Path under which alarms are created in IC Navigator.	"GrassValley/K2_Summit (<IP>)"
Poll Interval	pollInterval	Period between repeated SNMP polls to the device	30 seconds
Retries	retries	Number of times to retry after a failed SNMP poll	1 retry
Timeout	timeout	Number of seconds to wait for a response before declaring SNMP poll failed	3 seconds
Read Community	readCommunity	SNMP read community string (password)	"public"

Configurable parameters (*Continued*)

Parameter name	Parameter object key	Description	Default value
Write Community	writeCommunity	SNMP write community string (password)	"private"
Unique ID	uniqueID	Unique ID that will be embedded in alarm URI	""

MIBs used

MIB	MIB file name
RFC 1213	RFC1213-MIB.mib
Sencore 4400 mib. service alarms	SENCORE-MRD4400-MIB
Sencore CSP mib. Health alarms	SENCORE-CSP-MIB

ServerTech

Ordering information

Hardware	New in iControl version	GSM plug-in name	Order number
Switched CDU			

SkyStream

Please see [Ericsson](#), on page 48.

Snell

Ordering information

Hardware	New in iControl version	GSM plug-in name	Order number
Snell Routers		SNMP – Snell Router	IC-SNMP-027
Snell IQ Modular Interfaces		SNMP – Snell IQ	IC-SNMP-028

Snell Routers

A router control system supporting a variety of hardware and software control elements.

Snell IQ Modular Interfaces

The IQ Modular product line includes routers for HD/SD digital video and AES/EBU digital audio that can be controlled from a dedicated RCP, a card edge, a front panel or a PC running

RollCall network management software. The routers can be interfaced to an external RCP using a GPI module.

RollCall is a PC application enabling remote configuration and control functionality for RollCall-enabled infrastructure hardware.

Softel

Please see [Grass Valley](#), on page 88.

Sony

Ordering information

Hardware	New in iControl version	GSM plug-in name	Order number
CART+			
9-pin VTR Control (serial control)			

9-pin VTR Control (serial control)

Routers that enable control over a remotely controllable VCR or DDR with Sony protocol RS-422. Any 9-pin video device can be controlled by this interface. From your Visual Basic application it also can be used in Visual C, HTML or any other compiler.

SpectraLogic

Ordering information

Hardware	New in iControl version	GSM plug-in name	Order number
BOA over T380 Enterprise Tape Library	6.02	SNMP – SpectraLogic BOA	IC-SNMP-245

BOA over T380 Enterprise Tape Library

The SpectraLink T380 Tape Library is a tape-based enterprise-level data storage system. Grass Valley supports BOA on the T380.

Statmon

Ordering information

Hardware	New in iControl version	GSM plug-in name	Order number
Axess Remote Control (RC) System	4.30	SNMP – Statmon Axess	IC-SNMP-141

Axess Remote Control (RC) System

Statmon's Axess software is designed to manage NOCs, remote sites and wide ranges of devices regardless of brand or technology. The Axess RC system is a network-based application that remotely monitors devices, networks and systems where automatic control and response is required.

Studer

Ordering information

Hardware	New in iControl version	GSM plug-in name	Order number
Studer Route 6000		SNMP – Studer Route 6000 Audio Routing System	IC-SNMP-204

Studer Route 6000

The Studer Route 6000 is a routing and signal processing system based on the SCore Live DSP core and comprehensive D21m I/O system. The Route 6000 system can accommodate up to 1728x1728 inputs and outputs.

Sumavision Technologies, Inc.

Ordering information

Hardware	New in iControl version	GSM plug-in name	Order number
EMR-D8020	6.02	SNMP – Sumavision_EMRD8020 IRD	IC-SNMP-239

EMR-D8020



The EMR-D8020 is a stand-alone device, designed to fulfill the market demands of decoding head-end programs and receiving satellites. The EMR-D8020 supports stream inputs including DVB-S/S2, ASI, IP and so on, and output support ASI and TS over IP. In addition the decoding output option has HD-SDI, CVBS, YPbPr, HDMI, Analog Audio, AES/EBU Audio and the decoding input function supports FRAME_SYNC.

See the following for device support details:

- on page 206
- on page 209

Alarms

Alarm name	Type	MIB point	Further details
--- Health monitoring alarms ---			
Device Communication	Status/health	<code>sysUpTime</code> (RFC1213)	Raise a critical condition if the device stops responding to polling for a time period defined by <code>pollinterval X</code> retries.
Device Restart	Status/health	<code>sysUpTime</code> (RFC1213)	Raise a minor condition based on the value of <code>sysUpTime</code> read is smaller by at least 60 seconds compared to last reading. The value increase by 100 every second.
--- Input DVBS2 alarms ---			
All the following are elements related to signal input with tuner DVBS2. All those elements are display in a subfolder named 'Input DVBS2'.			
LockStatus	StatusText/Signal	<code>dvbs2InLockStatus</code>	DVB-S/S2 Input Status. "unlock" (Critical error) or "lock" (nominal case)
System Bitrate	Text/Signal	<code>systemBitrate</code>	System Bitrate Of DVBS/S2
Valid Bitrate	Text/Signal	<code>validBitrate</code>	Valid Bitrate Of DVBS/S2
Packet Length	Text/Signal	<code>packetLength</code>	Packet Length Of DVBS/S2
Signal Strength	StatusText/Signal	<code>signalStrength</code>	Strength Of Signal. If signal strength is inferior than <code>LBandLevelThreshold</code> param, or unknown, then the status is set to <code>CRITICAL</code> .
ber	Text/Signal	<code>ber</code>	BER Of Signal
snr	Text/Signal	<code>snr</code>	SNR Of Signal

Alarms (Continued)

Alarm name	Type	MIB point	Further details
DownLink Frequency	Text/Signal	downlinkFreq	DownLink Freq Of Signal. Range (0..100000)
Local Frequency	Text/Signal	localFreq	Local Freq Of Signal. Range (0..100000)
Symbol Rate	Text/Signal	symbolRate	Symbol Rate Of Signal. Range (1..999999)
Standard	Text/Signal	standard	Mode Of DVBS/S2. Can be "dvs-s" or "dvs-s2"
Polarize	Text/Signal	polarize	Polarize Of Signal. Can be "horizontal", "vertical" or "off"
Inb 22khz	StatusText/Signal	lnb22khz	LNB 22kHz Of Signal. "on" or "off".
Signal Status	StatusText/Signal	signalStatusOutput	"Print Choose Of Output Status""on" or "off".
Signal Monitor	StatusText/Signal	signalMonitor	Signal Monitor. "on" or "off".
Block Stream	StatusText/Signal	blockStream	Block Stream. "on" or "off".
Signal Level Threshold	Text/Signal	sigalLevelThreshold	SignalLevel Threshold. Range (1..10)
Alarm Enable	StatusText/Signal	alarmEnable	DVBS/S2 alarm OnOff. "on" or "off".

--- Input ASI alarms ---

All the following are elements related to signal input with type ASI. All those elements are displayed in a subfolder named 'Input ASI'.

LockStatus	StatusText/Signal	asiInLockStatus	ASI Input Status. "unlock" (Critical error) or "lock" (nominal case).
System Bitrate	Text/Signal	asiInSystemBitrate	System Bitrate
Valid Bitrate	Text/Signal	asiInValidBitrate	Valid Bitrate
Packet Length	Text/Signal	asiInPacketLength	Packet Length. "packet188" or "packet204"
Input Enable	StatusText/Signal	asiInEnable	Input OnOff. "on" or "off".
Input alarm enable	StatusText/Signal	asiInAlarmEnable	Alarm OnOff. "on" or "off".

--- Input IP alarms ---

All the following are elements related to signal input with type IP. All those elements are displayed in a subfolder named 'Input IP'.

LockStatus	StatusText/Signal	gbeInLockStatus	IP Input Status. "unlock" (Critical error) or "lock" (nominal case).
System Bitrate	Text/Signal	gbeInSystemBitrate	GBE System Bitrate
Valid Bitrate	Text/Signal	gbeInValidBitrate	GBE Valid Bitrate
Packet Length	Text/Signal	gbeInPacketLength	GBE Packet Length. "packet188" or "packet204"
Input IP	Text/Signal	gbeInIP	Receive Ip
Input Port	Text/Signal	gbeInPort	Receive Port.(0~65535)
Reference Bitrate Enable	StatusText/Signal	gbeInRefBitrateEnable	Reference bitrate enable. "on" or "off".

Alarms (Continued)

Alarm name	Type	MIB point	Further details
Reference Bitrate	Text/Signal	gbeInRefBitrate	Reference bitrate value.(0~200000000)
Alarm Enable	StatusText/Signal	gbeInAlarmEnable	Alarm OnOff of GBE input. "on" or "off".
Protocol	Text/Signal	gbeInProtocol	Protocol of GBE receive. "udp" or "rtp".

--- Output ASI alarms: Out 1 ---

All the following are elements related to signal output with type ASI.

There are two output ports. The following is the set of alarms for Port 1.

Subfolder: Output ASI/Out 1

System Bitrate	Text/Signal	asiOut1SystemBitrate	ASI port1 out System Bitrate
Valid Bitrate	Text/Signal	asiOut1ValidBitrate	ASI port1 Valid Bitrate
Stream source	Text/Signal	asiOut1Source	Stream source of ASI por1 out. Can be "asi", "dvb-s2", "ds3", "gbe", "descrambled"
alarm OnOff	StatusText/Signal	asiOut1AlarmEnable	ASI port1 out alarm OnOff. "on" or "off".

--- Output ASI alarms: Out 2 ---

All the following are elements related to signal output with type ASI.

There are two output ports. The following is the set of alarms for Port 2.

Subfolder: Output ASI/Out 2

System Bitrate	Text/Signal	asiOut2SystemBitrate	ASI port2 out System Bitrate
Valid Bitrate	Text/Signal	asiOut2ValidBitrate	ASI port2 Valid Bitrate
Stream source	Text/Signal	asiOut2Source	Stream source of ASI por2 out. Can be "asi", "dvb-s2", "ds3", "gbe", "descrambled"
alarm OnOff	StatusText/Signal	asiOut2AlarmEnable	ASI port2 out alarm OnOff. "on" or "off".

--- Output IP: Global Ethernet alarms ---

Ethernet Link Status	status/Signal	gbeLinkStatus	Link Status. Set to NORMAL if variable equals "Link up".
Speed Duplex	Text/Signal	gbeStatusSpeedDuplex	Status Of Speed Duplex

--- Output IP: Output port 1 alarms ---

System Bitrate	Text/Signal	gbeOut1SystemBitrate	GBE port1 out System Bitrate
Valid Bitrate	Text/Signal	gbeOut1ValidBitrate	GBE port1 Valid Bitrate
Stream source	Text/Signal	gbeOut1Source	Stream source of GBE por1 out. Can be "asi", "dvb-s2", "ds3", "gbe", "descrambled"
Dest IP	Text/Signal	gbeOut1DestIP	Dest IP of GBE port1 out.
Dest port	Text/Signal	gbeOut1DestPort	Destport of GBE port1 out.(0~65535)
TTL	Text/Signal	gbeOut1TTL	TTL Of GBE out port1 out.(1~255)
alarm OnOff	StatusText/Signal	gbeOut1AlarmEnable	Alarm OnOff of GBE port1 out. "on" or "off".

Alarms (Continued)

Alarm name	Type	MIB point	Further details
--- Output IP: Output port 2 alarms ---			
System Bitrate	Text/Signal	gbeOut2SystemBitrate	GBE port2 out System Bitrate
Valid Bitrate	Text/Signal	gbeOut2ValidBitrate	GBE port2 Valid Bitrate
Stream source	Text/Signal	gbeOut2Source	Stream source of GBE port2 out. Can be "asi", "dvb-s-2", "ds3", "gbe", "descrambled"
Dest IP	Text/Signal	gbeOut2DestIP	Dest IP of GBE port2 out.
Dest port	Text/Signal	gbeOut2DestPort	Destport of GBE port2 out.(0~65535)
TTL	Text/Signal	gbeOut2TTL	TTL Of GBE out port2 out.(1~255)
alarm OnOff	Statustext/Signal	gbeOut2AlarmEnable	Alarm OnOff of GBE port2 out. "on" or "off".

Configurable parameters

Parameter	Description
alarmPath	Used to set the Alarm prefix. Default value: Sumavision Could be replaced by IRD so as to have legacy plug-ins tree look-like.
pollInterval	Poller interval in seconds. Overwrites the default interval of 20 seconds.
retries	If an SNMP request times out, this defines the number of retries to be performed. Default: 1
timeout	Delay in seconds before declaring a timeout in the current SNMP request.
uniqueID	An extra identifier to be assigned to the plugin to differentiate its alarms from the other plugin of the same type. The uniqueID should be part of URI.
readCommunity	SNMP read community string. Use for SNMP polling. Default value: public
inputType	Defines the signal input type. Value can be DVB_S2 , ASI or IP Default value is DVB_S2
outputType	Defines the signal output type. Value can be ASI or IP Default value: IP
LBandLevelThreshold	Defines the threshold for the signal strength to be declared in alarm or OK. Default value: -45db

Tampa Microwave

Please see [Thales Defense & Security, Inc.](#), on page 177.

Tandberg Television

Please see [Ericsson](#), on page 48.

Tektronix

Ordering information

Hardware	New in iControl version	GSM plug-in name	Order number
Medius Application Manager		SNMP – Tektronix Medius	IC-TEKTRONIX-MEDIUS
Sentry Video Quality Monitor		SNMP – Tektronix Sentry	IC-TEKTRONIX-PROBE
MTM400 MPEG TS Monitor	6.04	SNMP – Tektronix MTM400	IC-SNMP-093
WFM 7200 Waveform Monitor		SNMP – Tektronix WFM 7200	IC-SNMP-181
WVR-Series Waveform Rasterizer		SNMP – Tektronix WVR611	IC-SNMP-020
		SNMP – Tektronix WVR7200	

Medius Application Manager

Medius offers an advanced reporting package that used to capture detailed QoE information that quickly highlights the top offending programs and/or locations. The reporting capabilities allow each user to generate customized reports that provide as much or as little detail as required, from monthly high-level reports for executive staff to immediate notices for technicians as incidents occur.

MTM400 MPEG TS Monitor



The MTM400 is a real-time MPEG Transport Stream monitor. The MTM400 provides a complete solution for transmission monitoring of MPEG Transport Streams over RF, IP, and ASI interfaces.

- on page 211
- on page 213

Alarms provided by the driver

Alarm name	Type	Poll/ Trap	Alarm URI	MIB node name	OID
--- Health Monitoring ---					
Communication Status	Status	Poll	driverCommStatus		
Device Reboot	Text	Poll	driverPowerCycle		
--- Errors ---					
BER (Pre Reed Solomon)	Status	Poll	I01/berPreReedSolomon	mifevtEventState	.1.3.6.1.4.1.128.5.1.17.2.12.1
BER (Pre Reed Solomon) Drift Limit	Status	Poll	I01/berPreReedSolomonDriftLimit	mifevtEventState	.1.3.6.1.4.1.128.5.1.17.2.12.1
BER (Pre Reed Solomon) Rate	Status	Poll	I01/berPreReedSolomonRate	mifevtEventState	.1.3.6.1.4.1.128.5.1.17.2.12.1
CNR	Status	Poll	I01/cnrDriftLimit	mifevtEventState	.1.3.6.1.4.1.128.5.1.17.2.12.1
CNR Drift Limit	Status	Poll	cnrDriftLimit	mifevtEventState	.1.3.6.1.4.1.128.5.1.17.2.12.1
CNR Limit	Status	Poll	I01/cnrLimit	mifevtEventState	.1.3.6.1.4.1.128.5.1.17.2.12.1
EVM Drift Limit	Status	Poll	I01/evmDriftLimit	mifevtEventState	.1.3.6.1.4.1.128.5.1.17.2.12.1
EVM Error	Status	Poll	I01/DVB/Errors/EVM	mifevtEventState	.1.3.6.1.4.1.128.5.1.17.2.12.1
EVM Limit	Status	Poll	I01/evmLimit	mifevtEventState	.1.3.6.1.4.1.128.5.1.17.2.12.1
MER	Status	Poll	I01/mer	mifevtEventState	.1.3.6.1.4.1.128.5.1.17.2.12.1
MER Drift Limit	Status	Poll	I01/merDriftLimit	mifevtEventState	.1.3.6.1.4.1.128.5.1.17.2.12.1
MER Limit	Status	Poll	I01/merLimit	mifevtEventState	.1.3.6.1.4.1.128.5.1.17.2.12.1
High Power Limit	Status	Poll	I01/highPowerLimit	mifevtEventState	.1.3.6.1.4.1.128.5.1.17.2.12.1
Low Power Limit	Status	Poll	I01/lowPowerLimit	mifevtEventState	.1.3.6.1.4.1.128.5.1.17.2.12.1
Power	Status	Poll	I01/power	mifevtEventState	.1.3.6.1.4.1.128.5.1.17.2.12.1

Alarms provided by the driver (Continued)

Alarm name	Type	Poll/ Trap	Alarm URI	MIB node name	OID
Power Drift Limit	Status	Poll	I01/powerDriftLimit	mifevtEventState	.1.3.6.1.4.1.128.5.1.17.2 .12.1
Interface Lock	Status	Poll	I01/ifLock	mifevtEventState	.1.3.6.1.4.1.128.5.1.17.2 .12.1
--- Warnings ---					
BER (Pre Reed Solomon)	Status	Poll	I01/berPreReedSolomonDriftLimitWarning	mifevtEventState	.1.3.6.1.4.1.128.5.1.17.2 .12.1
BER (Pre Reed Solomon) Drift Limit	Status	Poll	I01/berPreReedSolomonLimitWarning	mifevtEventState	.1.3.6.1.4.1.128.5.1.17.2 .12.1
BER (Pre Reed Solomon) Rate	Status	Poll	I01/berPreReedSolomonWarning	mifevtEventState	.1.3.6.1.4.1.128.5.1.17.2 .12.1
CNR Drift Limit Warning	Status	Poll	cnrDriftLimitWarning	mifevtEventState	.1.3.6.1.4.1.128.5.1.17.2 .12.1
CNR Limit Warning	Status	Poll	I01/cnrLimitWarning	mifevtEventState	.1.3.6.1.4.1.128.5.1.17.2 .12.1
CNR Warning	Status	Poll	I01/cnrWarning	mifevtEventState	.1.3.6.1.4.1.128.5.1.17.2 .12.1
EVM Drift Limit Warning	Status	Poll	I01/evmDriftLimitWarning	mifevtEventState	.1.3.6.1.4.1.128.5.1.17.2 .12.1
EVM Limit Warning	Status	Poll	I01/evmLimitWarning	mifevtEventState	.1.3.6.1.4.1.128.5.1.17.2 .12.1
EVM Warning	Status	Poll	I01/evmWarning	mifevtEventState	.1.3.6.1.4.1.128.5.1.17.2 .12.1
MER Drift Limit Warning	Status	Poll	I01/merDriftLimitWarning	mifevtEventState	.1.3.6.1.4.1.128.5.1.17.2 .12.1
MER Limit Warning	Status	Poll	I01/merLimitWarning	mifevtEventState	.1.3.6.1.4.1.128.5.1.17.2 .12.1
MER Warning	Status	Poll	I01/merWarning	mifevtEventState	.1.3.6.1.4.1.128.5.1.17.2 .12.1
High Power Limit Warning	Status	Poll	I01/highPowerLimitWarning	mifevtEventState	.1.3.6.1.4.1.128.5.1.17.2 .12.1
Low Power Limit Warning	Status	Poll	I01/lowPowerLimitWarning	mifevtEventState	.1.3.6.1.4.1.128.5.1.17.2 .12.1

Alarms provided by the driver (*Continued*)

Alarm name	Type	Poll/ Trap	Alarm URI	MIB node name	OID
Power Drift Limit Warning	Status	Poll	I01/powerDriftLimitWarning	mifevtEventState	.1.3.6.1.4.1.128.5.1.17.2 .12.1
Power Warning	Status	Poll	I01/powerWarning	mifevtEventState	.1.3.6.1.4.1.128.5.1.17.2 .12.1

Certain parameters can be passed to the driver, as follows:

Parameters

Name	Description/Notes	Default value	Configurable in GUI
pollInterval	Poller interval in seconds. Overwrite the default interval.	10	NO
retries	If an SNMP request times out, this defines the number of retries to be performed.	1	NO
timeout	Delay in seconds before declaring a timeout in the current SNMP request.	5	NO
uniqueID	An extra identifier to be assigned to the plugin to differentiate its alarms from the other plugin of the same type. The uniqueID should be part of uri.		NO
readCommunity	SNMP read community string, used for SNMP polling.	Public	NO
writeCommunity	SNMP write community string, used to send SNMP-set commands.	Private	NO

Sentry Video Quality Monitor

Tektronix Sentry is a comprehensive video and audio quality monitoring solution for advanced video networks. It enables video service providers to deliver high-quality services while reducing operational expenditures.

WFM 7200 Waveform Monitor

The Tektronix WFM 7200 waveform monitor provides a wide variety of video format support and can also include support for Analog, Digital and Dolby audio formats. The monitoring and measurement capabilities of the WFM7200 provide a comprehensive suite of options and configurations to suit a variety of applications. Within a studio or on-location within a truck, match and balance up to four cameras to insure the look of the production from camera to camera, and scene to scene. For 3D Stereoscopic Monitoring, a variety of different 3D monitoring modes are available to assist you in determining the difference between the *Left Eye* and *Right Eye* views.

WVR-Series Waveform Rasterizer

The Tektronix WVR-series of waveform rasterizers help video content producers verify content quality and make precision content adjustments. In video delivery systems, they help

operations staff verify content quality and system reliability, and help engineering staff qualify, install, and maintain video systems. Design and manufacturing engineers developing new video equipment use the waveform monitor for design troubleshooting, functional verification, and manufacturing test.

Terayon

Please see [Motorola](#), on page 177.

Thales Defense & Security, Inc.

Ordering information

Hardware	New in iControl version	GSM plug-in name	Order number
VC1800 Carrier Monitoring System		SNMP – Tampa Microwave VC 1800	IC-SNMP-120

VC1800 Carrier Monitoring System

(Formerly Tampa Microwave VC1800 Carrier Monitoring System)

The VC1800 Remote Satcom Carrier Monitoring System is an integrated spectrum monitoring solution that indicates when a carrier problem occurs, and provides tools to restore the link. The VC1800 monitors parameters such as signal power, bandwidth and C/No. The system also detects when an interfering signal is present. It can automatically watch carriers and generate an audible alarm or SNMP alert.

TSL (Television Systems Ltd.)

Ordering information

Hardware	New in iControl version	GSM plug-in name	Order number
MDU Mains Distribution Unit		SNMP – TSL MDU12	IC-SNMP-094

MDU Mains Distribution Unit

Main Distribution Unit that provides automatic Set Top Box (STB) power cycling. Works with SC-11 Under Monitor Display System Controller. MDU-12-B provides 12-way fused mains distribution from a single input. MDU-12-3E provides remote monitoring of any number of MDUs for input and output status via an Ethernet connection. The unit can be monitored using an SNM interface.

T-VIPS

Ordering information

Hardware	New in iControl version	GSM plug-in name	Order number
TVG-Series Gateways/CP-Series Processors	4.40	SNMP – T-VIPS TVG-Series Gateways/CP-Series Processors	IC-SNMP-195

TVG-Series Gateways/CP-Series Processors

CP505 — ATSC Processor

The CP505 ATSC Processor offers flexible ASI, SMPTE 310 and IP network adaptation and advanced Transport Stream processing in a user-friendly and compact 1RU solution.

The CP505 provides an powerful solution for adaptation of MPEG Transport Streams to ATSC broadcast and other transport stream processing applications. The CP505 is offered in two different variants.

The basic model provides format conversion between SMPTE-310M, ASI, transport stream over IP using RJ45 Electrical connections as well as SFP Optical interfaces, SDH and PDH interfaces.

The advanced model offers the basic features plus powerful PID and program filtering with PSIP rebranding and PSI/SI processing.

TVG425 — Transport Stream Gateway

The TVG425 is a transport stream gateway offering real-time contribution and distribution of compressed video over IP networks. It provides transparent handling of up to 8 independent MPEG Transport Streams (TS), flexible interfacing with support for ASI, Ethernet and SONET/SDH, as well as output diversity and input switching capabilities.

Videoframe Inc.

Ordering information

Hardware	New in iControl version	GSM plug-in name	Plug-in order number
VF0037 GPI VNODE		GPI VNODE	

VF0037 GPI VNODE

A VNODE™ is a small-scale signal monitoring system used where there are few monitoring points, where the monitoring points are distributed over a wide area, or where centralized monitoring is not a requirement. There are six different models.

The VF0037 GPI VNODE contains relay output GPI capability for generating local alarm responses. It can report defects to an SNMP manager, or respond to defects by setting its own GPI relays.

Wegener Communications

Ordering information

Hardware	New in iControl version	GSM plug-in name	Plug-in order number
DTV720 Transport Stream Multiplexer		SNMP – Wegener DTV720	IC-SNMP-097

DTV720 Transport Stream Multiplexer

The Wegener DTV720 provides multiplexing options for small cable operators, allowing them to repackage off-air 8VSB and local ASI streams into their headends.

XOR Media (formerly SeaChange [Broadcast Division])

Ordering information

Hardware	New in iControl version	GSM plug-in name	Plug-in order number
BML Servers		SNMP – Seachange BML	IC-SNMP-011.1
MCL Codec Servers		SNMP – Seachange MCL	
VOD Server		SNMP – Seachange VOD	

BML Servers

XOR Media's Broadcast Media Library (BML)-series of servers is a high-capacity, low cost, scalable, and fault-resilient digital media library.

MCL Codec Servers

XOR Media's MediaClient 6300 (MCL 6300) is a modular and multi-format video server codec that is fully compatible with the XOR Broadcast MediaLibrary 24000ex and the 12000ex systems using the latest hardware platform.

XOR Media's MediaClient 8200 is the latest in the series of broadcast-quality modular codecs that offer multi-resolution and multi-format operations.



Grass Valley Technical Support

For technical assistance, contact our international support center, at 1-800-547-8949 (US and Canada) or +1 530 478 4148.

To obtain a local phone number for the support center nearest you, please consult the *Contact Us* section of Grass Valley's website (www.grassvalley.com).

An online form for e-mail contact is also available from the website.

Corporate Head Office

Grass Valley
3499 Douglas-B.-Floreani, St-Laurent, Québec H4S 2C6, Canada
Telephone: +1 514 333 1772
Fax: +1 514 333 9828
Web: www.grassvalley.com