

MRC

Miranda Router Configurator v3.5.0

User's Guide

UG0051-01

3 Feb 2014



A **BELDEN** BRAND

Copyright & Trademark Notice

Copyright © 2014, Miranda Technologies Partnership. All rights reserved.

Belden, Belden Sending All The Right Signals, and the Belden logo are trademarks or registered trademarks of Belden Inc. or its affiliated companies in the United States and other jurisdictions. Miranda, NVISION, and *Miranda Router Configurator* are trademarks or registered trademarks of Miranda Technologies Partnership. Belden Inc., Miranda Technologies Partnership, and other parties may also have trademark rights in other terms used herein.

Terms and Conditions

Please read the following terms and conditions carefully. By using Miranda Router Configurator documentation, you agree to the following terms and conditions.

Miranda Technologies Partnership (“Miranda”) hereby grants permission and license to owners of the Miranda Router Configurator (MRC) to use their product manuals for their own internal business use. Manuals for Miranda products may not be reproduced or transmitted in any form or by any means, electronic or mechanical, including photocopying and recording, for any purpose unless specifically authorized in writing by Miranda.

A Miranda manual may have been revised to reflect changes made to the product during its manufacturing life. Thus, different versions of a manual may exist for any given product. Care should be taken to ensure that one obtains the proper manual version for a specific product serial number.

Information in this document is subject to change without notice and does not represent a commitment on the part of Miranda.

Warranty information is available in the Support section of the Miranda Web site (www.miranda.com).

Title	MRC User’s Guide
Part Number	UG0051-01
Revision	1.1 (03 Feb 14)

Change History

Rev	Date	ECO	Description of Changes	Approved By
1.0	24 Apr 13	18826	Initial release with MRC v3.3.1	D.Cox
1.1	03 Feb 14	19133	Conforms to MRC v3.5.0 and v3.5.2 hybrid firmware. Added material for pass-through and stereo audio, for frame sync cards, and for Sony's ROT-16 protocol.	D.Cox

Notice

Due to continued product development, the accuracy of the information in this document may change without notice. The information and intellectual property contained herein is confidential between Miranda and the client and remains the exclusive property of Miranda. If you find any problems in the documentation, please report them to us in writing. Miranda does not warrant that this document is error-free.

All title and copyrights as well as trade secret, patent and other proprietary rights in and to the Software Product (including but not limited to any images, photographs, animations, video, audio, music, test, and "applets" incorporated into the Software Product), the accompanying printed materials, and any copies of the Software Product, are owned by Miranda Technologies. The Software Product is protected by copyright laws and international treaty provisions. Customer shall not copy the printed materials accompanying the software product.

The software contains proprietary information of Miranda Technologies. It is provided under a license agreement containing restrictions on use and disclosure and is also protected by copyright law. Reverse engineering of the software is prohibited.

Software License Agreement and Warranty Information

Contact Miranda for details on the software license agreement and product warranty.

toc

Table of Contents

1 Getting Started.....	1
PC Requirements.....	2
Assigning IP Address to PC.....	2
Installing MRC.....	6
Verifying Your Installation.....	9
2 Using MRC.....	11
Overview of MRC.....	11
MRC Tools.....	13
Network Setup.....	14
Configuration.....	14
Router Tools.....	15
Configurator Tools.....	15
Selecting a Control Card.....	15
Control Card State Indicators.....	16
Refreshing the Control Card Display.....	17
Saving Configuration Changes.....	17
The MRC Interface.....	18
Using Tabbed Tables.....	18
Table Commands.....	20
Keyboard Commands.....	22
Icons.....	22
Setting Preferences.....	23
Screen Size.....	23
Other Topics.....	23
Context Menu.....	23
Nomenclature.....	25
3 Configuring Routers.....	27
Firmware Page.....	28
Using the Firmware Page.....	29
Choosing a Firmware file.....	30
'Used on This Control Card' Option.....	30
'All Available' Option.....	31
The 'Available' Column.....	31
Context Menu.....	32
Updating Firmware.....	32
Creating a Module Selection Rule.....	32
Viewing and Saving Update Logs.....	37
Router Levels Page.....	37
Using the Router Levels Page.....	38
Network Frame Summary.....	39
Physical Levels.....	39
Level Types.....	40
Special Case for NV8500 Hybrid Routers.....	41

Table of Contents

Adding and Updating Levels	41
Deleting Levels	42
Special Audio Sources	43
Regions of the Special Audio Section	44
Null Audio Source	44
Pass-Through Audio Sources	45
Input Attributes Page	48
Card Selection	49
Caveats	49
Nomenclature	50
Context Menu	50
Output Attributes Page	50
Using the Output Attributes Page	51
AES Reference Options	52
Dual Video Reference Options	52
Output Range	53
The Attributes Table	53
Output Attributes Context Menu	54
Configuring and Updating Output Attributes	55
Miscellaneous Page	57
Serial Port Settings	58
Viewing Serial Port Settings	58
Router Serial Settings	59
Control Card Settings	59
Ethernet Protocol Settings	60
Configuring Serial Ports	61
How to Configure Serial Ports	61
Expansion Settings	61
How to Set a Frame as Main or Expansion	62
Module Types	63
Selecting Slots	65
Context Menus	65
Hybrid Routers Table	65
Module Type Table	65
Setting the Card Type	66
Resetting Card Types after a Firmware Update	66
Using the Module Types Page	66
Viewing a Subset of the Modules	67
Assigning Module Types	67
Troubleshooting Module Type Errors	67
Copy Settings Page	69

4 Router Tools 75

Crosspoints Page	76
Diagnostic Levels	77
Context Menus	77
"Live" Changes	78
Salvos	78
Locks and Protects	78
Takes	79
Takes for Non-Existent Ports (for NV8500 Series Routers)	79
Takes for Ports Belonging to Empty Slots	79
Caveats	81

Using the Crosspoints Page	82
Icons and Context Menu Options	83
Locating Outputs	84
Selecting a Level	85
Viewing a Crosspoint Matrix	86
Performing Takes	87
Single Input to Single Output	87
Range Takes	88
Diagonal Takes	90
Incrementing Takes Tab	92
How to Perform Incremental Takes	93
History Tab	94
The History Tools	96
Single Takes Tab	96
How to Perform Single Takes	97
How to Perform Chop Takes	98
Copying and Pasting Crosspoint Data	98
Copy	98
Paste	98
Using Salvos	101
Creating and Updating a Salvo	103
Opening a Salvo and Uploading its Crosspoint Data	104
Deleting a Salvo	105
Logs Page	106
System Status	107
Status Panels	108
Module Status Page	109
Network Frame Summary	110
List of Modules	110
Individual Module State	112
Graphic	114
Selecting Modules	114
Using the Module Status Page	115
Troubleshooting Module Status Errors	115
View Change Report	115
View Status Report	116

5 Network Setup 117

NVISION Series Products Page	118
Network Interfaces Button	119
Ethernet Settings Page	119
Frame Sync Cards	120
Using the Page	120
Entries for Control Cards	121
Entries for Frame Sync Cards	122
Adding and Removing Control Cards	122
Adding Control Cards	122
Removing Control Cards	122
Creating Virtual Control Cards	123
Locking and Unlocking Configurations	126
Updating an IP Address	127

6 Tutorials	129
The MRC Network	129
What is an IP Address?	130
What is a Subnet?	130
What is a Subnet Mask?	131
What is a Gateway IP Address?	131
Cabling	131
Using Switches	131
Routing	131
What is a Router?	132
The Crosspoint Matrix Inside the Router	133
Sources and Destinations	133
Signal Types	133
Available Signal Types	134
Levels	134
Mono and Stereo Switching	135
Mono and Stereo in the NV8500 Hybrid Routers	135
Mono and Stereo in Other Routers	135
Video Fields and Frames	135
About Vertical Timing	135
SMPTTE Standards for Switch Point	136
External References and Switch Point Configurations	136
Redundant and Dual Video References	139
Switching "Rules"	139
Null Audio	139
Pass-Through Audio	139
AFV Partition	139
Force Embedder On	140
Tally	140
Understanding How the Rules Combine	140
Embedded Group Control	141
Pass-Through Sources	142
Basic and Extended Pass-Through	142
Configuring Pass-Through	143
Basic Pass-Through Source	143
Extended Pass-Through Sources	143
Notes	145
Synchronous Stereo Audio Level	146
Stereo Port Numbers	146
Crosspoint Page	146
Example 1	147
Example 2	147
IOXM Extended Status Data	148
Module Types	148
Video Formats	149
IOXM Extended Status Reporting	149
Standard Input	149
Standard Output	149
Hybrid Output	149
Hybrid Input	150
MADI Input	150
AES Input	150
AES Output	150
Standard Crosspoint (EM0986)	150
Standard Crosspoint (EM0662)	150

Std Redundant XPT..... 151
Hybrid Crosspoint (144×144) 151

Glossary 153

Index 155

Contact Us 165

Table of Contents

1 Getting Started

The Miranda Router Configurator (MRC) is a software application that runs on your PC and communicates with an NVISION series router¹ through the router's control cards. MRC lets you perform all configuration tasks through a comprehensive set of configuration pages and status pages. (See [Using MRC](#) on page 11.)

This user's guide assumes that you have basic computer skills and a basic understanding of networks and NVISION series routers.

Topics

<i>Before Configuring</i>	1
<i>PC Requirements</i>	2
<i>Assigning IP Address to PC</i>	2
<i>Installing MRC</i>	6

Before Configuring

Before you can start using MRC to configure NV8500 routers, complete the following tasks:

Task	Description	Related Topic
Verify the router installation	Make sure that the router being configured has input, output, crosspoint, monitor and control cards installed and that all required reference signal connections have been made.	—
Connect serial ports	Some third-party router control systems require a serial connection to the control card. Be sure that all of the router's serial connections to the router control system have been made.	Miscellaneous Page on page 57
Set up a network	Set up a network that includes the PC on which MRC is installed, an Ethernet switch, and the router(s) being configured. Contact your system administrator for assistance.	The MRC Network on page 129
Assign an IP address to your PC	Assign the appropriate IP address to the PC that will be running MRC. After the PC is set up, MRC will discover all Ethernet connections automatically; usually no settings need be entered. All control cards display on MRC's 'Ethernet Settings' page.	Assigning IP Address to PC on page 2
Install MRC	To install MRC, available on the SB0033 CD, insert the CD in your CD drive, and choose 'Configuration Software' from the main window that appears. Then click 'Install MRC' and follow the directions. The installation takes less than a minute.	Verifying Your Installation on page 9

1. MRC can also configure other devices that have an "NVISION series" control card.

PC Requirements

MRC is installed on a PC with the following:

- Windows® 2000, Windows® XP, Windows® Vista or Windows® 7. A Macintosh or Linux version can be made available if you request it. Contact Miranda customer service.
- A late model Pentium-class processor.
- At least 90 MB of disk space
- A CD drive (optional)
- 256 MB or more RAM

In addition, the following items are necessary to allow MRC and routers to communicate:

- A 100baseT Ethernet port in your configuration PC that can use a fixed IP address on the same subnet as your routers and control panels.
- 100 Mb/s Ethernet switch with at least 4 ports.
- Ethernet cables (category 5 or better).

Assigning IP Address to PC

You must assign an IP address to the PC on which MRC will be installed. The PC must be assigned an IP address on the subnet you intend to use for the MRC network. Typically, the subnet is 192.168.1.xxx.

(For an overview of networks and subnets, see [The MRC Network](#) on page 129.)

If you have multiple subnets in your router system, you might want to add those subnets to your PC's network configuration.

How to Configure the PC IP Address

- 1 Depending on your operating system, from the PC's *Start* menu, choose:

From the Windows XP Start menu,

Settings > Network Connections

or

All Programs > Accessories > Communications > Network Connections,
whichever is available.

From the Windows Vista or Windows 7 Start menu,

Control Panel > Network and Sharing Center.

- 2 Double-click 'Local Area Connection'.

The 'Local Area Connection Status' window appears.

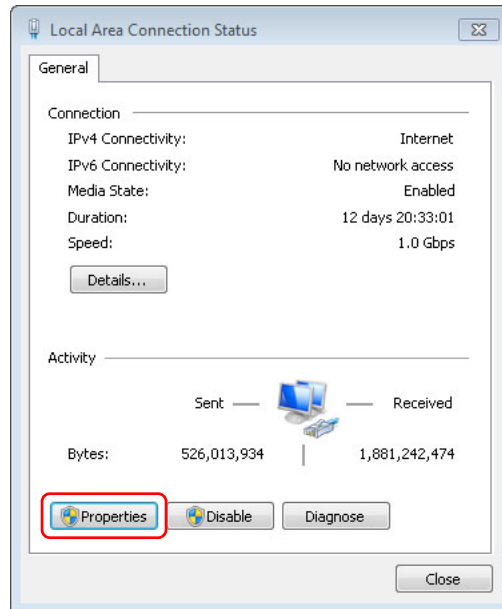

Windows 7

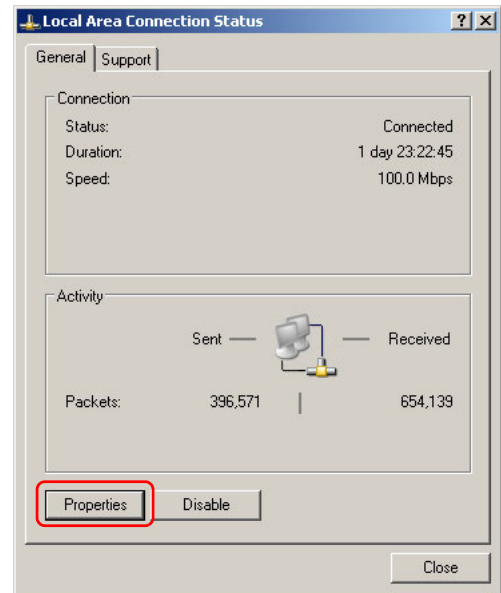

Windows XP

If multiple tabs display, select the **General** tab. Click **Properties**.

3 The 'Local Area Connection Properties' window appears.

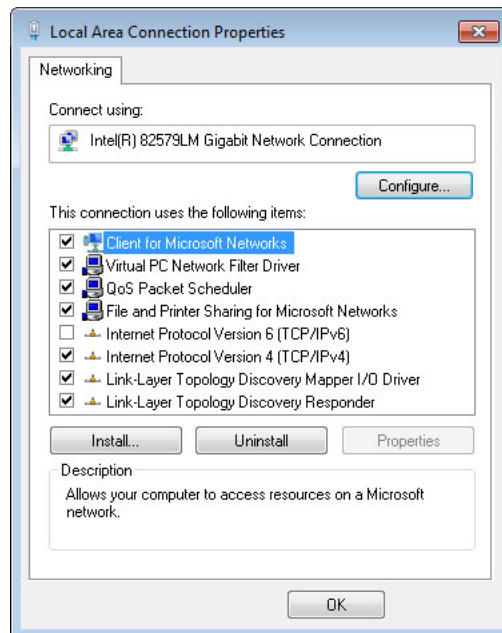

Windows 7

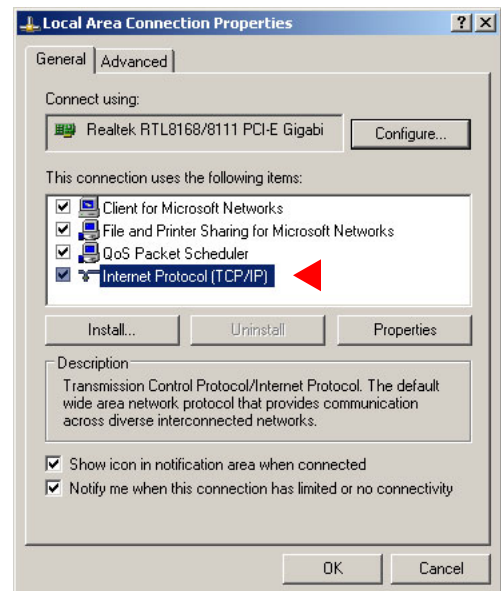

Windows XP

Select **Internet Protocol Version 4 (TCP/IPv4)** or **Internet Protocol (TCP/IP)**. Click **Properties**.

4 The 'Internet Protocol (TCP/IP) Properties' window appears.

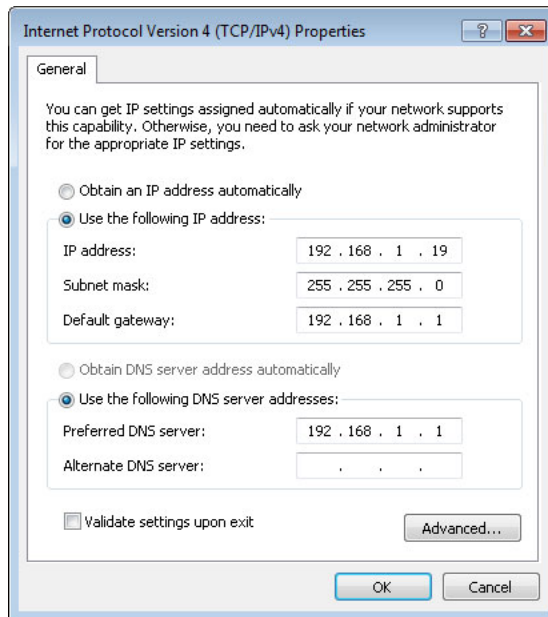

Windows 7

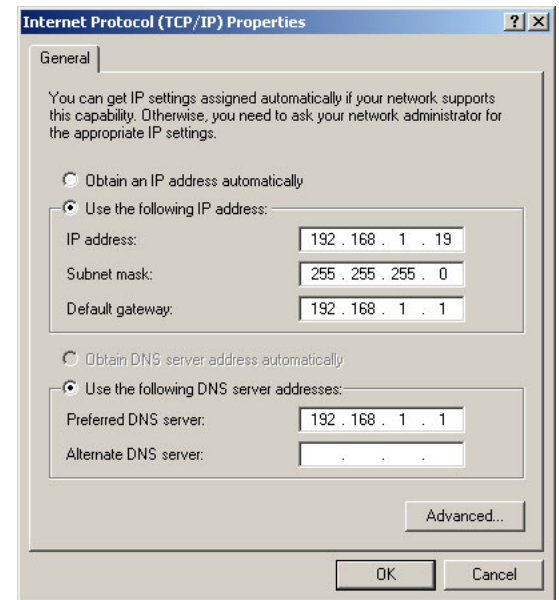

Windows XP

5 Choose **Use the following IP address** and enter an IP address for your PC. It is recommended that you use the IP address 192.168.1.19. The IP address must be unique on the MRC network. The subnet mask must be 255.255.255.0.

(For details, see [The MRC Network](#) on page 129.)

6 Click **OK** to save your changes.

How to Create Additional Subnets

- 1 Starting from step 5 in the preceding procedure, click **Advanced**.

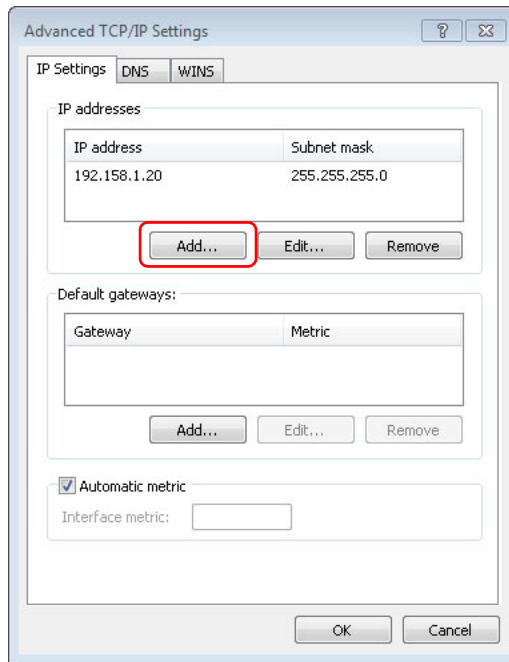

Windows 7

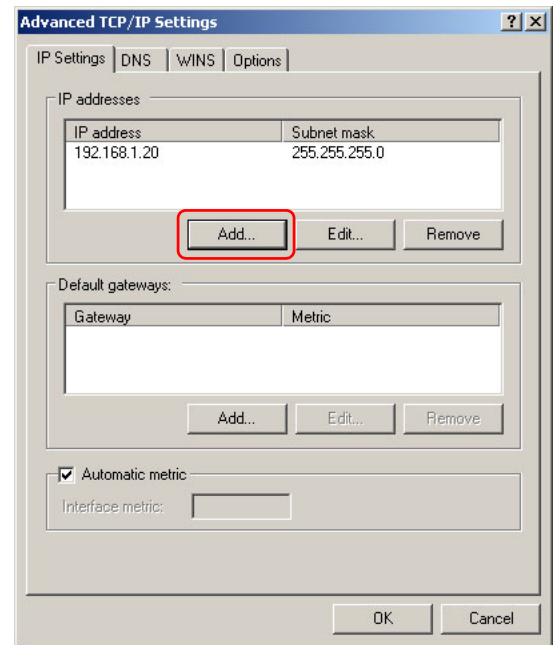

Windows XP

- 2 Click **Add . . .** and enter an IP address.
- 3 Repeat step 2 for additional IP addresses.
- 4 After adding IP addresses for your subnets, click **OK**.

Installing MRC

MRC is available on the SB0033 Software and Documentation CD. To install MRC:

- 1 Insert the CD in your CD drive.

Wait for the initial screen:

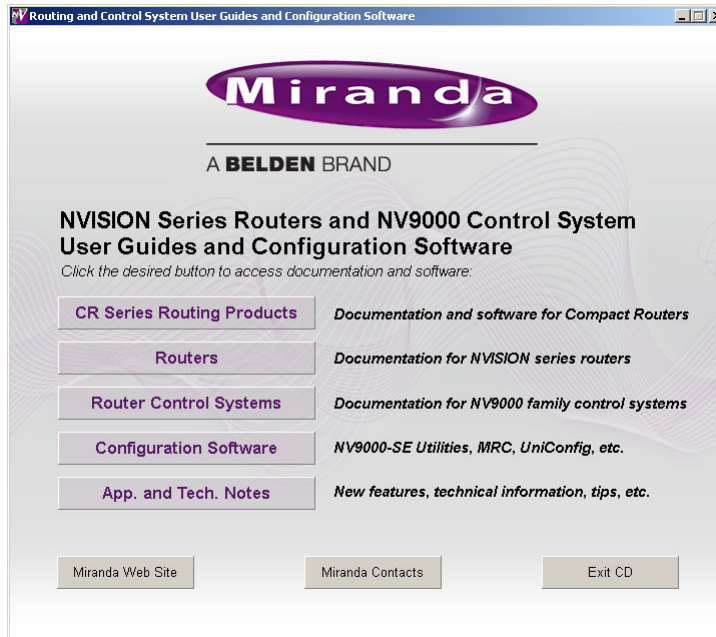

Click the 'Configuration Software' button.

- 2 The 'Routing Products Software' page appears:



Click 'Install MRC'.

3 The installation script will begin to run:

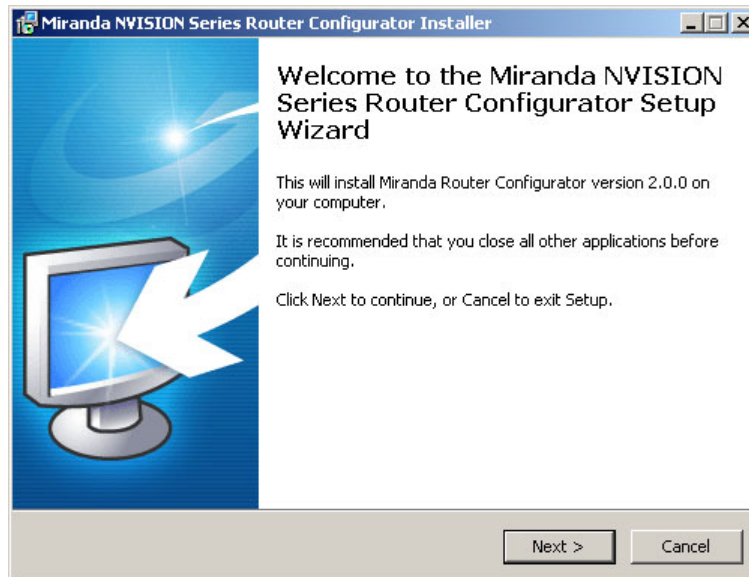

Click 'Next'.

4 A window appears in which you can designate the location on your PC in which to install MRC:

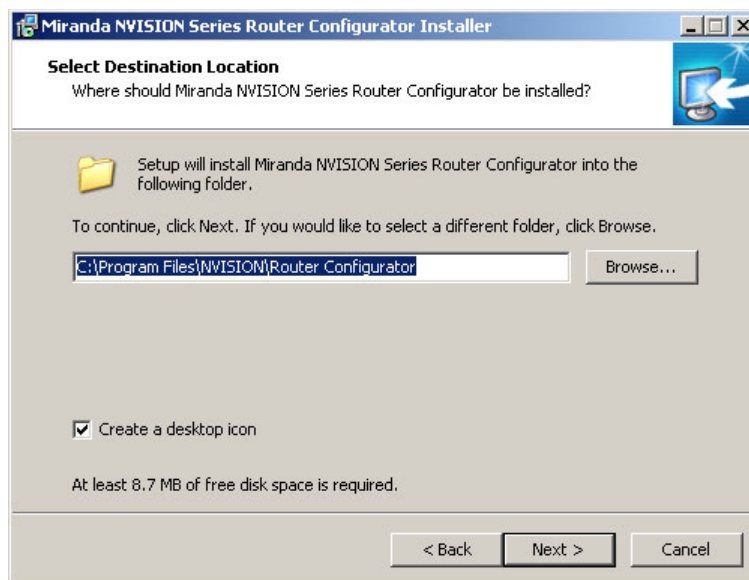

The window presents the default location. If you prefer another location, click 'Browse' to navigate to a different folder.

Uncheck 'Create a desktop icon' if you do not want an MRC shortcut to appear on your PC desktop.

The window tells you the disk space needed for the installation. If you do not have that much space, the installation will fail.

When you are satisfied with the pathname and options, click 'Next'.

5 A confirmation window appears:

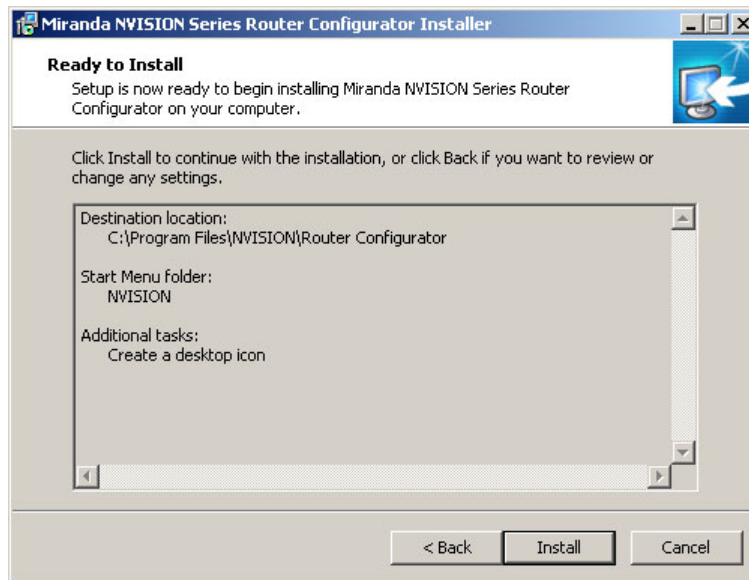

If the options presented are not correct, click 'Back' to go back to the previous window and re-enter a pathname or change options.

Otherwise, click 'Next' to start the installation or click 'Cancel' to stop the installer.

When you start the installation, a progress window appears:

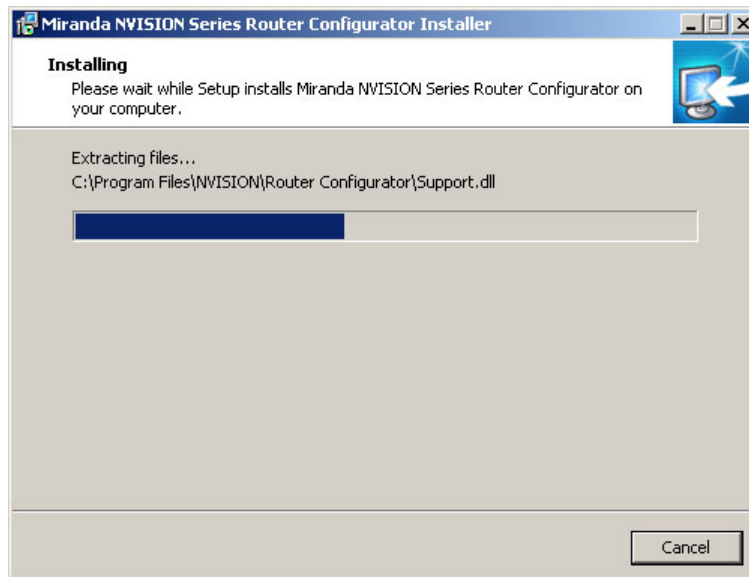

6 After several seconds, the installation will complete. The completion window appears:

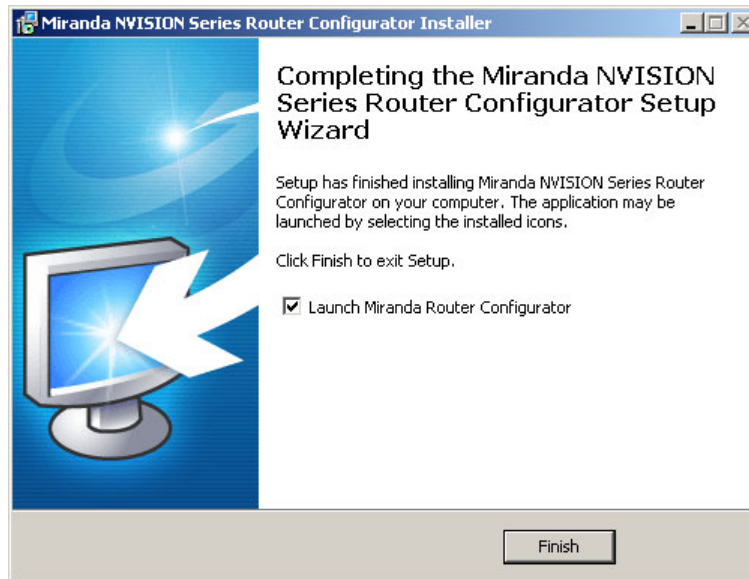

Uncheck 'Launch Miranda Router Configurator' if you do not want to run MRC immediately.

7 Click 'Finish'.

Verifying Your Installation

After you have installed MRC, launch MRC by clicking its desktop icon or selecting 'NVISION > Miranda Router Configurator' from the PC's list of programs. Then, from MRC's navigation pane, click 'Ethernet Settings' to open the 'Ethernet Settings' page and view a list of control cards in the network.

Click 'Refresh List' in the 'Ethernet Settings' page.

Examine the list of control cards and note whether any of the following problems exist:

- No entries in the list.

Either you have no network, the network is not properly connected to the PC, or there are no control cards on the network. Ensure that the PC has an Ethernet connection to the Ethernet switch for the network.

Click the 'Network Interfaces' button in MRC's 'NVISION Series Products' page to determine to which subnets your configuration PC is connected.

One of your router frames might be disconnected or receiving no power. Check Ethernet connections, power connections, and power supplies of the router.

- Entries read *IP Conflict*. There might be duplicate IP addresses on the network. To correct this, find and change IP address so that all IP addresses are distinct. See [The MRC Network](#) on page 129.

- Entries read *Different Subnet*. These entries are for devices that are detectable by MRC, but are not on a currently available subnet. To view available subnets, hover your mouse over "Different Subnet." A popup context menu of available subnets appears.

There are several corrections for this type of entry:

- Change the IP address of the device to the current subnet.
- Change the IP address or subnet of the configuration PC.
- Change the IP address in some other way, but leaving the device on some other subnet.
- Physically remove the device from the network by disconnecting the connecting cables.

Correct any problems and click 'Refresh List' on the 'Ethernet Settings' page to view an updated list of devices. Once the network is functioning properly, you are ready to use MRC to perform configuration tasks.

2 Using MRC

The Miranda Router Configurator (MRC) is a software application used to set up and modify configuration settings and perform diagnostics for NV8500 series *hybrid* routers.

MRC also has limited (i.e., incomplete) support for other routers and for other devices that have control cards. Routers other than NV8500 series hybrid routers should be configured with UniConfig. In particular, NV8500 series *standard* routers should be configured with UniConfig.

Topics

<i>Overview of MRC</i>	11
<i>MRC Tools</i>	13
<i>Selecting a Control Card</i>	15
<i>Saving Configuration Changes</i>	17
<i>The MRC Interface</i>	18
<i>Setting Preferences</i>	23

MRC is periodically updated at Miranda with new features and functionality. Miranda automatically notifies you of available updates whenever your copy of MRC is connected to the Internet for longer than 5 minutes.

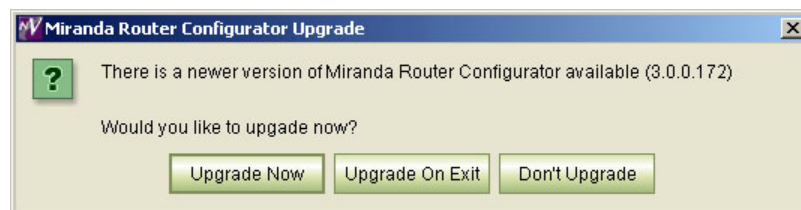

To obtain an update, click **Upgrade Now** or **Upgrade On Exit** on the dialog window that appears. If you do not want to upgrade, click **Don't Upgrade**. The next time you launch MRC, the download options will appear again, allowing you to upgrade at that time.

Overview of MRC

MRC runs on a PC and communicates with the router's control cards over Ethernet.

MRC configures the router by applying settings to the router's control card, by updating firmware in the I/O cards, crosspoint cards, and monitor cards, and by changing settings in the EEPROM on the router's backplane. MRC communicates with the control cards through Ethernet connections.

Some third-party router control systems use a serial protocol and require that serial connections be configured within MRC. (See [Serial Port Settings](#) on page 58.)

NVISION Ethernet protocol is always available through the router's Ethernet connections. NVISION serial protocol is always available through the CTRL 2 serial ports. Other protocols can be active on the CTRL 1 ports. The routers have two sets of ports, one for the primary control

card and one for the secondary (redundant) control card in the router frame. For details about the serial ports, see the router's documentation. The control card allows only one third-party protocol to be loaded at any one time.

MRC fully supports these NV8500 series hybrid routers (i.e., those that use an EM0833 control card):

NV8144	144 × 144
NV8140	144 × 288
NV8280	288 × 576
NV8576	576 × 1152
NV8576-Plus, single frame	576 × 576
NV8576-Plus, expanded (two frames)	1152 × 1152

For information about the NV8500 routers, see the *NV8500 Series Routers User's Guide*.

MRC has limited support for all other NVISION series routers and some other devices that have NVISION series control cards, such as the EC9535.

An NV8500 series *standard* router (one that uses an EM0666 control card), and all other routers are configured primarily by *UniConfig* or *UniDiag* configuration software. Contact Miranda for more information.

MRC Tools

After you launch MRC, it presents a window with two parts: a navigation pane to the left, and a work area to the right.

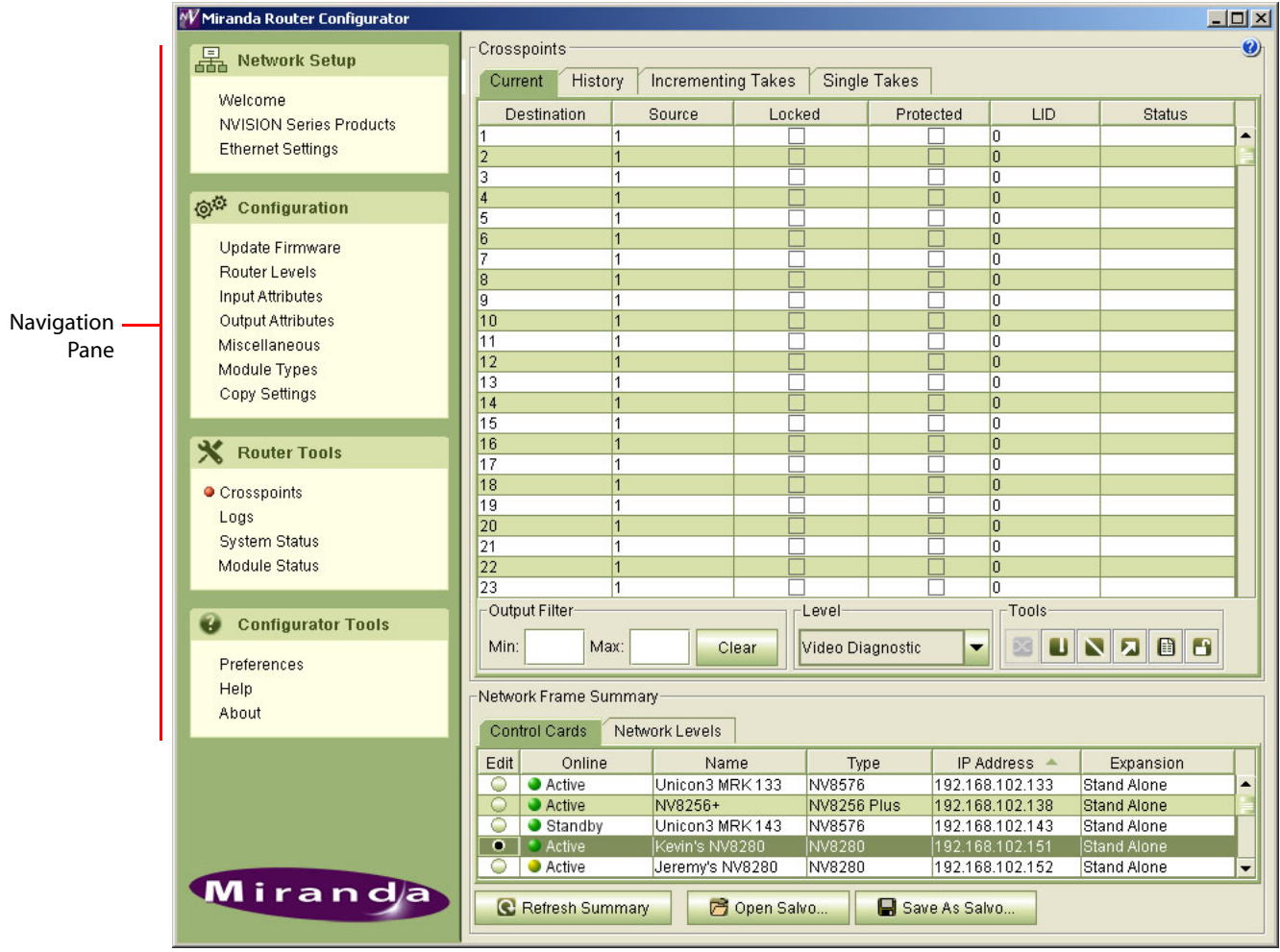

Work Area

The navigation area is divided into sections based on function: [network setup](#), [configuration](#), [router tools](#), and [configurator tools](#). Within each of these sections are links to pages (tools) that perform specific tasks.

Network Setup

The 'Network Setup' section provides an introduction to MRC, lists all devices detected by MRC and supports control card management, including adding and removing, and creating "virtual" cards, locking configurations, and updating IP addresses. These are its pages:

Page	Description	Related Topic
Welcome	A brief introduction to MRC and a summary of MRC tools.	—
NVISION Series Products	Lists all NVISION series devices known to MRC.	NVISION Series Products Page on page 118
Ethernet Settings	Manages IP addresses, virtual control cards, and adding or removing cards.	Ethernet Settings Page on page 119, The MRC Network on page 129

Configuration

The 'Configuration' section provides tools for configuring a router by making settings in the router's control card. Control card configurations can be copied to another control card. These are its pages:

Page	Description	Related Topic
Firmware	Lists firmware, version information, and uploads new firmware to control cards and IOXM cards.	Firmware Page on page 28
Router Levels	Configures router levels. A router control system uses level information to communicate with the router control cards and to manage the switching matrix.	Routing on page 131. Router Levels Page on page 37. Levels on page 134. Signal Types on page 133
Input Attributes	Specifies "output embedder" settings for NV8500 hybrid router inputs.	Input Attributes Page on page 48
Output Attributes	Sets parameters for individual outputs. Different video and audio formats require different switch points to prevent switching artifacts. Also makes reference settings.	Output Attributes Page on page 50. Video Fields and Frames on page 135. Redundant and Dual Video References on page 139
Miscellaneous	Manages router serial settings. Also configures which router frame is <i>main</i> and which are <i>expansion</i> frames for expanded routers.	Miscellaneous Page on page 57
Module Types	Specifies which module belongs in a specific card slot in an NV8500 hybrid router frame. Allows for initial setup verification and future alarming if a module is removed or an incorrect module is installed.	Module Types on page 63
Copy Settings	Either copies selected control card settings from one physical control card to another physical control card or creates a "virtual" control card whose settings can be imported to physical control cards.	Copy Settings Page on page 69

Router Tools

After your router is configured, you can use the pages of the 'Router Tools' section to monitor system status and module status, manage the switching matrices, and view alarm messages. These are its pages:

Page	Description	Related Topic
Crosspoints	Displays, tests, and updates crosspoints. Testing and updating is done by performing "takes."	Crosspoints Page on page 76 Routing on page 131
Logs	Displays startup log data and current running log data for a selected control card.	Module Types on page 63
System Status	Displays the "health" of a router's active or standby control card, frame, alarms, power supplies and fans. The page also displays the overall health of all the modules in the system and the state of the slot configuration.	System Status on page 107
Module Status	Lists the modules physically installed in a router frame and gives the location and "health" of each module.	Module Status Page on page 109

MRC automatically updates system and status information every 8 seconds.

Configurator Tools

The 'Configurator Tools' section provides preference settings, application version information, and online Help.

Page	Description	Related Topic
Preferences	Allows you to re-enable warning messages that you have disabled.	Setting Preferences on page 23
Help	Opens MRC's online help. This entry in the 'Configurator Tools' section does not correspond to an MRC page.	—
About	Presents version information, disclaimers, copyright, and other product information.	—

These are "tools" that help you use MRC.

Selecting a Control Card

To perform configuration tasks, you must generally select a router's control card.

When a control card is selected, it is selected in all MRC pages associated with that control card. For example, if you select a control card on the **Control Cards** tab in the 'Crosspoints' page, that same control card is automatically selected on all pages in which the **Control Cards** tab appears.

Typically, control cards are selected from the **Control Cards** tab. However, on the 'Switch Points' page and 'Module Types' page, only hybrid routers are configurable so it is the **Hybrid Routers** tab that you use.

IMPORTANT

Each control card in a router must be configured separately and identically.

With two control cards, one control card is active and the router can remain operational while configuration changes are being made to the inactive control card.

How To Select a Control Card

In the 'Network Frame Summary' section, click the **Control Cards** tab (or the **Hybrid Routers** tab) to bring the page forward. Then click the radio button on the row listing the control card you want. Control cards are identifiable both by name and by IP address.

Note: merely clicking on a row listing a control card highlights the row, but does not select the control card.

Control Card State Indicators

Control cards are listed one per row. On each row, a colored dot appears in the *Online* column.

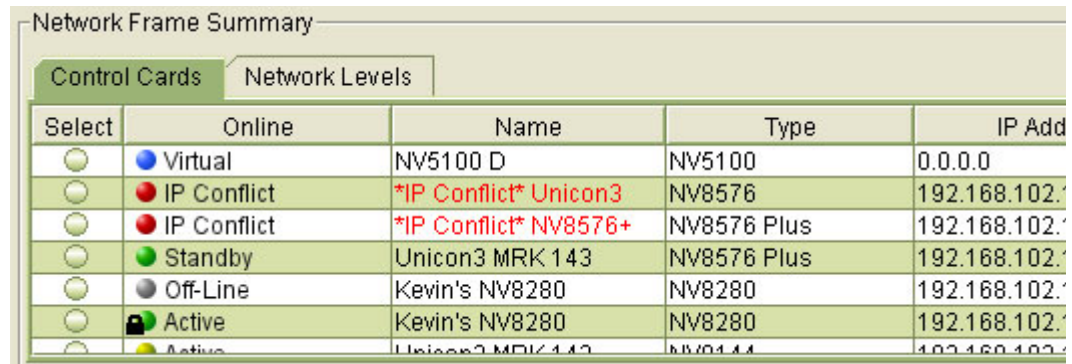

The screenshot shows a table titled 'Network Frame Summary' with two tabs: 'Control Cards' and 'Network Levels'. The 'Control Cards' tab is active. The table has five columns: 'Select', 'Online', 'Name', 'Type', and 'IP Add'. The rows represent different control cards with their respective status indicators (colored dots) and lock icons.

Select	Online	Name	Type	IP Add
<input type="radio"/>	Virtual	NV5100 D	NV5100	0.0.0.0
<input type="radio"/>	IP Conflict	*IP Conflict* Unicon3	NV8576	192.168.102.7
<input type="radio"/>	IP Conflict	*IP Conflict* NV8576+	NV8576 Plus	192.168.102.7
<input type="radio"/>	Standby	Unicon3 MRK 143	NV8576 Plus	192.168.102.7
<input type="radio"/>	Off-Line	Kevin's NV8280	NV8280	192.168.102.7
<input type="radio"/>	Active	Kevin's NV8280	NV8280	192.168.102.7
<input type="radio"/>	Active	Unicon3 MRK 143	NV8576 Plus	192.168.102.7

The color of the dot indicates the state and type of card, as follows:

- Green — the control card is functioning normally. Communication between MRC and the router is good and without interruption.
- Yellow — the control card is in an "unhealthy" state even though no interruption in communication between MRC and the router has occurred. You can open the 'System Status' page to view diagnostic messages. (See [System Status](#) on page 107.)
- Red — the control card is in a faulty state and all communication has been stopped. You can open the 'System Status' page to view the extent of failure. (See [System Status](#) on page 107.)
- Grey — the control card is offline and MRC cannot communicate with it.
- Blue — represents a virtual control card. A "virtual" control card is one that does not physically exist but for which there is a configuration. (See [Creating Virtual Control Cards](#) on page 123.)

A (black) lock icon indicates that a control card configuration has been locked. For details, see [Locking and Unlocking Configurations](#) on page 126.

Refreshing the Control Card Display

In general, all control card information that displays in MRC is current. However, any time you physically add or remove a control card from a router frame, you should click **Refresh Summary**. Doing so ensures that changes in the router frame are communicated to MRC.

You can click **Refresh Summary** at any time.

Saving Configuration Changes

Configuration settings are stored in non-volatile memory (EEPROM) on the control card. The EEPROM stores all configuration settings entered through MRC, but not crosspoint data.

Crosspoint data are stored on the control card in battery-backed RAM. Each control card has its own memory and must be configured separately. All control cards of a router must have identical configurations.

Changes made in MRC are not automatically applied to the control card. For your changes to take effect, you must click **Update Control Card**.

You can continue to use MRC while a control card updates.

If you make changes and do not click **Update Control Card**, MRC will display a *warning* window providing you with three options.

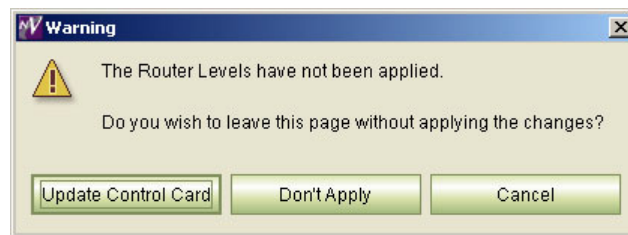

Click the option you want:

- **Update Control Card**— save all changes made in the current session and send the changes to the control card.
- **Don't Apply**— close the current page without saving any changes.
- **Cancel**— Return to the currently open page with all changes still displaying. Changes are *not* sent to the control card.

The MRC Interface

The MRC window is divided into two main sections. In the left-hand section is the navigation pane containing links to pages within MRC. To open a page, click a link in the navigation pane. The corresponding page displays in the right-hand section.

An orange dot appears on the navigation pane to the left of the link indicating that the page is open.

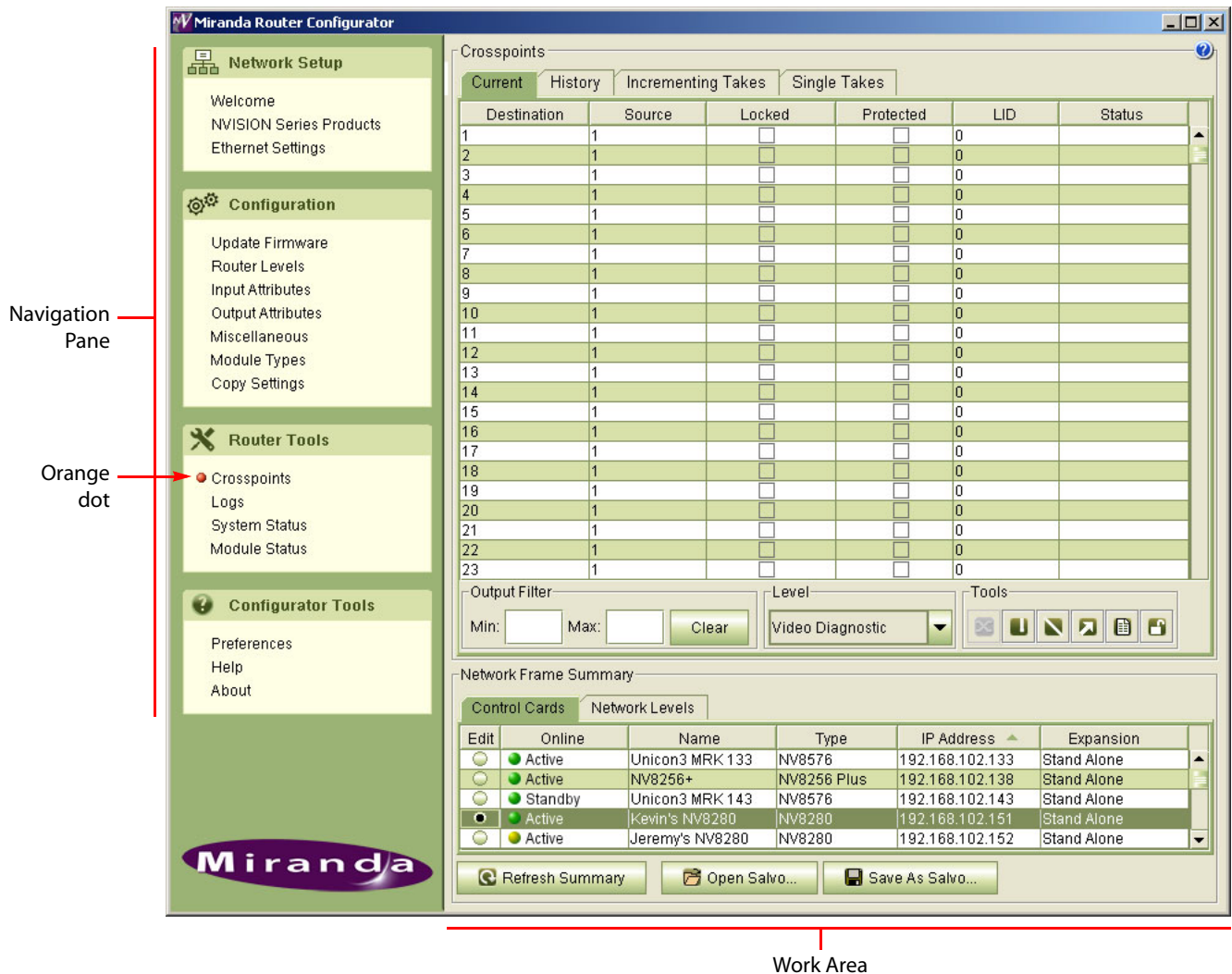

Using Tabbed Tables

All pages of the 'Configuration' and 'Router Tools' sections have a 'Network Frame Summary' at the bottom of the page. The summary section is divided into tabs. To bring a tab to the front, click the tab title.

Only tables that apply to the tasks to be performed appear in that particular page.

The following is a list of all tabs that display in the *Network Frame Summary*:

- **Control Cards** — lists all control cards in the MRC system. This tab is used to select a control card to configure.
- **Hybrid Routers** — used to select a control card in a hybrid router frame. When this tab appears, functions are restricted to hybrid router frames.
- **All Control Cards** — lists all control cards in the MRC system. This tab is used for information only; control cards cannot be selected in this tab. On pages where this tab appears, control cards have been filtered to display on either the **Hybrid Routers** tab or the **Video Routers** tab.
- **Network Levels** — lists all levels in the MRC system and their associated parameters. This tab is for information only. See [Levels](#) on page 134.
- **Video Routers** — used to select a control card in a video router frame. When this tab appears, functions are restricted to control cards installed in video router frames.
(There are no tabs for audio routers or machine control routers.)

Each row of a tabbed table represents a single control card (or a single level). The table's columns either allow the selection of a control card or provides details about the control card or the level listed on that row.

The following list describes the columns that appear in the tabbed tables:

Tabbed Table	Column	Description
'Control Cards' or 'Hybrid Routers' or 'Video Routers'	Edit / Select	Click the radio button to select the control card listed on that row.
	Online	Indicates whether the control card is currently active and communicating with the router control system. When the entry says 'Active', the control card is the currently active card. When the entry says 'Standby', the card is the inactive (on standby) card. The term 'Virtual' indicates a virtual control card. (See Creating Virtual Control Cards on page 123.)
	Name	The name assigned to the router frame in which the control card is installed.
	Type	The router model number, such as NV8280.
	IP Address	The IP address currently assigned to the control card.
	Expansion	Indicates whether the control card is installed in an expanded router. 'Stand Alone' indicates that the frame is not connected to another frame. 'Expanded - Main' indicates that the router is an expanded router and the frame is the main frame. 'Expanded - Expansion' indicates that the router is an expanded router and the frame is an expansion frame, not the main frame. (See Expansion Settings on page 61.)

Tabbed Table	Column	Description
Network Levels	Level	The name of the level.
	Signal Type	The signal type associated with the level.
	Router	The router frame to which the level is assigned.
	Physical Inputs	The physical inputs on the router frame at which the level starts and ends.
	Controller Sources	Logical numbers in the router control system at which this level begins and ends, for source devices.
	Physical Outputs	The physical outputs on the router frame at which the level starts and ends.
	Controller Dests	Logical numbers in the router control system at which this level begins and ends, for destination devices.
All Control Cards	Online	Indicates whether the control card is currently active and communicating with the router control system via the network. 'Active' in this field means that the control card is currently active and considered the primary control card. 'Secondary' means that the card is the inactive control card. 'Virtual' means that the card is a virtual control card (and not a physical card). See Creating Virtual Control Cards on page 123.
	Name	The name of the router.
	Type	The router model number, such as NV8280.
	IP Address	The IP address currently assigned to the control card.
	Subnet Mask	The subnet mask currently assigned to the control card.

Table Commands

When you are using any of the tables, the following functions are available:

- **Highlighting**—Clicking anywhere in a row changes the color of the row to the highlight color (deep green, as opposed to white or light green), making the row distinguishable from the other rows. *Highlighting a row does not select the item in the 'Control Cards' table, the 'Hybrid Routers' table, or the 'Video Routers' table.* To select an item represented by a row, such as a control card, click the radio button in that row:

Select	Online	Name	Type	IP Address	Exp:
<input type="radio"/>	Standby	TSQ 8576	NV8576	192.168.102.210	Stand Alone
<input checked="" type="radio"/>	Active	TSQ 8576	NV8576	192.168.102.211	Stand Alone

- **Check box**—Click a check box to select the item in that row. Click the check box again to unselect the item. You can check more than one check box at any one time. Checked items are processed together when you issue a command.

<input checked="" type="checkbox"/>	Active	Unicon3 MRK 222	NV8576	192.168.102.222	255.255.255.0	192.168.102.222
<input checked="" type="checkbox"/>	Standby	Unicon3 MRK 223	NV8576	192.168.102.223	255.255.255.0	192.168.102.223
<input type="checkbox"/>	Active	NV5128	NV5128	192.168.102.225	255.255.255.0	
<input type="checkbox"/>	Active	NV5128	NV5128	192.168.102.248	255.255.255.0	

- Radio button—Click on a radio button to select the item in that row. You can select only one row at a one time using radio buttons.

Select	Online	Name	Type	IP Address	Exp:
<input type="radio"/>	Standby	TSQ 8576	NV8576	192.168.102.210	Stand Alone
<input checked="" type="radio"/>	Active	TSQ 8576	NV8576	192.168.102.211	Stand Alone

- Ordering—Clicking the title bar above a column toggle between placing the table in ascending or descending order on the basis of the values in that column. An arrow appears indicating the direction of the ordering.

IP Address	
192.168.102.133	Sta
192.168.102.143	Sta
192.168.102.190	Sta
192.168.102.211	Exp
192.168.102.214	Exp
192.168.102.222	Sta
192.168.102.223	Sta

If no arrow appears in the column heading, the table is not sorted with respect to that column.

- Tool tips—In fields that are enabled for editing, when you hover your mouse over the field, a “tool tip” appears. “Tool tips” are brief descriptions or instructions.

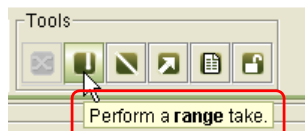

- Changing column size—Drag the line that divides two columns right or left to increase or decrease the column width.

Online	Name
--------	------

A horizontal arrow cursor appears when you have selected the column boundary.

- Drop-down lists—Some column fields accept values presented in a drop-down list. These fields have an arrow beside the field. Click the arrow to view the options in the list. Click on an option in the list to apply it or to select it.

3	Use Switching Rules	UI-001
4	Use Switching Rules	UI-001
5	Use Switching Rules	UI-001

Keyboard Commands











Standard keyboard and mouse commands are available in MRC.

- Mouse click — Use your mouse to click on an individual row or cell to select it or activate the field for editing.
- Control (ctrl) key — To select non-consecutive multiple rows or items, press the control key on your keyboard while using the mouse to click on each additional row or item you want to select. Each row or item is highlighted. To deselect, click again on the row or item.
- Shift key — To select consecutive multiple rows or items, press the shift key while using the mouse to click another row or item. All the rows (or items) from the previous selection to the new row (or item) become selected. The rows or items are highlighted. To deselect, click anywhere in the series of rows or items.
- Right-click — Right-click on a row to use a context menu (if one is available).

For detailed instructions, see your operating system's user's guide.

Icons

You can click on an icon or use keyboard shortcuts, when they are available, to perform the following tasks:

Menu Option	Icon	Equivalent Keyboard Actions
Copy		Press Ctrl + C
Paste		Press Ctrl + V
Delete		Press the Delete key
Create Salvo		—
Save As Salvo		Press Ctrl + S
Crosspoint ^a		—
Jump to Output		—
Unlock All		—
Range Take		Press Ctrl + R
Audio Range Take		—
Diagonal Take		Press Ctrl + D

- a. This might be labeled a "Take" button in MRC. It does *not* perform a take, but sends crosspoint data to the router's crosspoint matrix.

The context menu has 3 or 4 options, depending on where you are in MRC. These are the options:

- Configuration Locked.

This option has a check box. If the box is checked, the configuration of the control card you have selected is locked.

Click on this option if you want to lock a control card configuration (and it is not already locked). A warning appears:

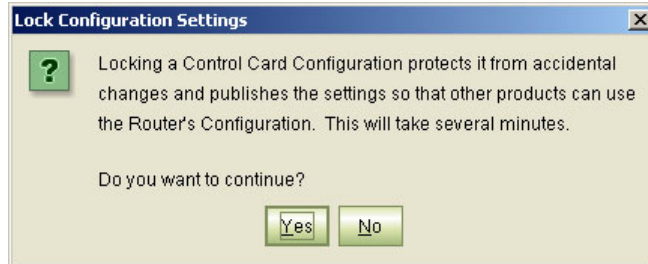

Click **YES** to lock the configuration.

- Reset control card.

Click this option to reset the physical control card.

- Export configuration.

Click this option to save the control card configuration to a .zip file.

- Set Expansion frames.

When you are working with expanded routers (main plus expansion frames), you will work with the main frame primarily. MRC does not yet have the ability to recognize which frame is the matching expansion frame.

If you select a main frame, MRC will ask you to identify the expansion frame(s) in the following dialog:

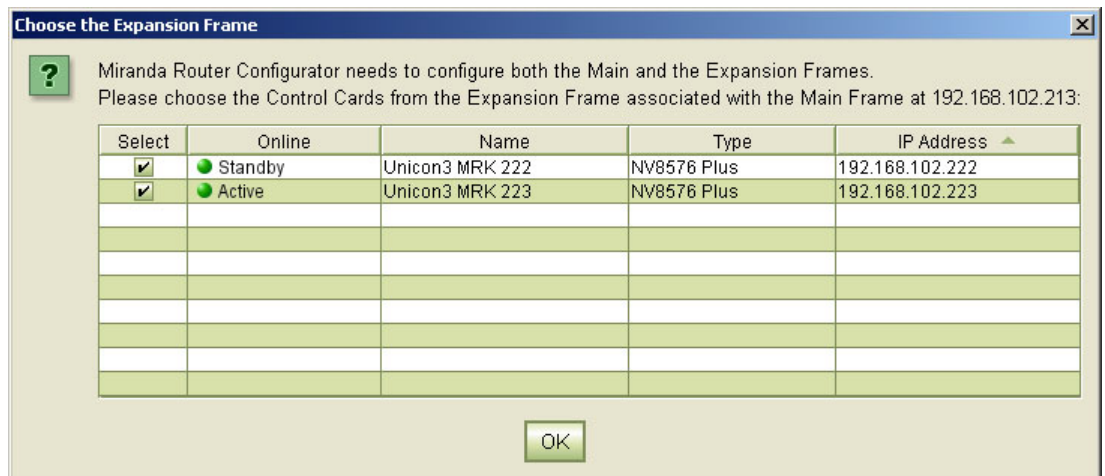

You can use the same dialog with the 'Set Expansion Frames' command in the context menu.

Nomenclature

Certain abbreviations are used throughout MRC:

IOXM	Card classification: <u>i</u> nput, <u>o</u> utput, <u>x</u> pt (crosspoint) or <u>m</u> onitor
TDM ¹	Means "MADI" (TDM is the way individual MADI signals are transported.)
DEM	Disembedder (or de-embedder)
EMB	Embedder
UI	Upper input
LI	Lower input
UO	Upper output
LO	Lower output
SDI	Means video (literally, serial digital interface)
SD	Standard-definition
HD	High-definition
3Gig	Video at 2.97 or 2.967 Gb/s.

1. Time domain multiplexing.

3 Configuring Routers

When its control card(s) are present in the MRC network, a router can be configured. MRC's 'Configuration' section has several tools with which you can update firmware, create router partitions, set reference and switch point parameters, govern communication between connected router frames, and specify the location of modules within the router frame.

Topics

Firmware Page	28
Router Levels Page	37
Input Attributes Page	48
Output Attributes Page	50
Miscellaneous Page	57
Module Types	63
Copy Settings Page	69

The 'Configuration' section includes the following tools (or pages): 'Firmware', 'Router Levels', 'Input Attributes', 'Output Attributes', 'Miscellaneous', 'Module Types', and 'Copy Settings'. Each page lets you perform a specific set of configuration tasks:

Task	Description	Related Topic
Upload the latest router firmware	The router's firmware is essential to its correct operation. Firmware affects communication between the router control system and router control cards. The 'Firmware' page updates the firmware currently loaded on control cards, I/O cards, monitor cards, and crosspoint cards in the router frame.	Firmware Page on page 28
Create levels (partitions) for switching	Router control systems use level information to communicate with the router and manage the crosspoint connections. Use the 'Router Levels' page to configure levels.	Router Levels Page on page 37
Set switch points	A "switch point" is a point in time at which a router output is to be switched from its current input to a new input. The 'Output Attributes' page lets you set different video and audio format switch points to prevent switching artifacts.	Output Attributes Page on page 50
Add serial port settings	Some third-party router control systems require serial ports to be configured for proper communication. The 'Miscellaneous Settings' page governs serial port settings. This page also establishes which frame is the "main" frame in an expanded router.	Miscellaneous Page on page 57
Force embedders to be on, as needed	At times, it is necessary to force embedders (in hybrid output cards) on for the duration of a route. You can specify for which input ports this is done.	Input Attributes Page on page 48

Task	Description	Related Topic
Assign module types to module slots	The 'Module Types' page assigns card types to the router's card slots. This helps verify that your initial installation is correct and later warns you about potentially incorrect module changes.	Module Types on page 63
Copy control card settings to another control card	This page makes configuration of multiple control cards easier. The 'Copy Settings' page copies control card settings to another physical card or to a "virtual" control card or from a "virtual" control card.	Copy Settings Page on page 69

Firmware Page

The 'Firmware' page is a means to upload selected firmware to all the control cards, input and output cards, monitor cards, and crosspoint cards installed in the router. A firmware update is a rare but vital event. Control cards must have the correct firmware loaded to execute commands from the router control system successfully and to communicate with MRC successfully. Firmware is pre-installed on the router at the factory.

This is the 'Firmware' page:

The screenshot shows the 'Router Firmware File' section with the file name 'NV8500_HYB_FW_3.3.0.2537.RF' and a 'Choose...' button. Below it is the 'Current Firmware Versions' table.

Update	Needs Update	Name	Version	Description
<input type="checkbox"/>	<input type="checkbox"/>	CPLD	1.0.0.0	
<input type="checkbox"/>	<input type="checkbox"/>	ROM	2.0.0.0	EM0833ROM Jun 10 2011 11:40:33
<input checked="" type="checkbox"/>	<input checked="" type="checkbox"/>	Control Card	Unknown	EM0833 Firmware - May 4, 2012
<input type="checkbox"/>	<input type="checkbox"/>	IOXM-I-001	1.0.0.1	NV8140 3Gig SDI 18 COAX IN (EM0887)
<input type="checkbox"/>	<input type="checkbox"/>	IOXM-I-005	1.0.0.1	NV8140 3Gig SDI 18 COAX IN (EM0887)
<input type="checkbox"/>	<input type="checkbox"/>	IOXM-I-008	1.0.0.1	NV8140 3Gig SDI 18 COAX IN (EM0887)
<input type="checkbox"/>	<input type="checkbox"/>	IOXM-O-001	13.0.0.2	NV8500 3Gig SDI 18 COAX OUT (EM0785)
<input type="checkbox"/>	<input type="checkbox"/>	IOXM-O-016	13.0.0.2	NV8500 3Gig SDI 18 COAX OUT (EM0785)
<input type="checkbox"/>	<input type="checkbox"/>	IOXM-X-001	20.0.0.1	NV8500 144x144 3Gig XPT STD (EM0894)
<input type="checkbox"/>	<input type="checkbox"/>	IOXM-X-003	20.0.0.1	NV8140 144x144 3Gig RED XPT STD (EM0895)

Below the table are buttons: 'Select All', 'Select If Needs Update', 'Select None', 'Select...', and a checked checkbox for 'Update only if versions are different'.

The 'Network Frame Summary' section has tabs for 'Control Cards' and 'Network Levels'. The 'Control Cards' tab shows a table:

Select	Online	Name	Type	IP Address	Expansion
<input type="radio"/>	Active	Kevin's 0200	NV8280	192.168.102.199	Stand Alone
<input type="radio"/>	Active	Jowel's NV8140	NV8140	192.168.102.167	Stand Alone
<input type="radio"/>	Active	QA_NV8140	NV8140	192.168.102.213	Stand Alone
<input type="radio"/>	Active	QA_NV8280	NV8280	192.168.102.214	Stand Alone
<input type="radio"/>	Standby	QA_NV8280	NV8280	192.168.102.215	Stand Alone
<input type="radio"/>	Active	NV5128	NV5128	192.168.102.248	Stand Alone
<input type="radio"/>	Active	NV5128	NV5128	192.168.102.249	Stand Alone

Buttons at the bottom include: 'Refresh Summary', 'Update Firmware...', 'View Past Update Logs...', and 'Reset Control Card...'.

Miranda is continually improving firmware to make control card and other active module communication the most effective and reliable it can be. In addition, changes in router configurations may necessitate new firmware be uploaded. Miranda makes an effort to notify customers when firmware updates become available. You can also contact Miranda technical support at any time to verify that you have the latest versions.

IMPORTANT

Updating firmware causes the router's control card to reset. A firmware update takes the router offline. It is recommended that firmware updates be performed during a service period when the router can be scheduled to be offline.

WARNING

All routers must be disconnected from *all* router control systems during a firmware update. If they are not disconnected, the router control system will continue to communicate with the router, interfering with the firmware update.

Using the Firmware Page

To update firmware in a router, you must select its control card (in the 'Control Card' table at the bottom of the 'Firmware' page). If the router has two (or more) control cards, you must perform the same updates for each control card.

After you select a control card, click **Choose** at the upper right to select a firmware (.rf) file. See [Choosing a Firmware file](#) on page 30.

When you select a control card, MRC scans all modules in the router frame and lists the currently installed firmware versions in the 'Firmware' page. With respect to your selected firmware file, if a module contain firmware for which a different version is available, MRC displays the module name, version number, and description in bold red text.

Update	Needs Update	Name	Version	Description
	<input type="checkbox"/>	CPLD	1.0.0.0	
	<input type="checkbox"/>	ROM	4.0.0.0	EM0833ROM Oct 1 2010 09:37:32
<input checked="" type="checkbox"/>	<input checked="" type="checkbox"/>	Control Card	1.1.1.1517	EM0833 Firmware - April 15, 2011
<input type="checkbox"/>	<input type="checkbox"/>	IOXM-UI-004	7.0.0.0	NV8500 3Gig SDI DEM 8 COAX IN (EM0814, SV0984-07)
<input type="checkbox"/>	<input type="checkbox"/>	IOXM-UI-005	7.0.0.0	NV8500 3Gig SDI DEM 8 COAX IN (EM0814, SV0984-07)
<input type="checkbox"/>	<input type="checkbox"/>	IOXM-UI-028	7.0.0.0	NV8500 3Gig SDI DEM 8 COAX IN (EM0814, SV0984-07)
<input type="checkbox"/>	<input type="checkbox"/>	IOXM-UI-029	6.0.0.0	NV8500 3Gig COAX 8 SDI / 1 TDM IN (EM0814, SV1015-06)
<input type="checkbox"/>	<input type="checkbox"/>	IOXM-LI-035	7.0.0.0	NV8500 3Gig SDI DEM 8 COAX IN (EM0814, SV0984-07)
<input type="checkbox"/>	<input type="checkbox"/>	IOXM-LI-062	7.0.0.0	NV8500 3Gig SDI DEM 8 COAX IN (EM0814, SV0984-07)
<input type="checkbox"/>	<input type="checkbox"/>	IOXM-UO-001	11.0.0.0	NV8500 3Gig SDI 18 COAX OUT (EM0785-02, SV0825-11)
<input type="checkbox"/>	<input type="checkbox"/>	IOXM-UO-002	11.0.0.0	NV8500 3Gig SDI 18 COAX OUT (EM0785-02, SV0825-11)
<input type="checkbox"/>	<input type="checkbox"/>	IOXM-UO-003	11.0.0.0	NV8500 3Gig SDI 18 COAX OUT (EM0785-02, SV0825-11)
<input type="checkbox"/>	<input type="checkbox"/>	IOXM-UO-030	11.0.0.0	NV8500 3Gig SDI 18 COAX OUT (EM0785-02, SV0825-11)
<input type="checkbox"/>	<input type="checkbox"/>	IOXM-UO-031	11.0.0.0	NV8500 3Gig SDI 18 COAX OUT (EM0785-02, SV0825-11)
<input type="checkbox"/>	<input type="checkbox"/>	IOXM-UO-032	11.0.0.0	NV8500 3Gig SDI 18 COAX OUT (EM0785-02, SV0825-11)
<input type="checkbox"/>	<input type="checkbox"/>	IOXM-LO-033	11.0.0.0	NV8500 3Gig SDI 18 COAX OUT (EM0785-02, SV0825-11)
<input type="checkbox"/>	<input type="checkbox"/>	IOXM-LO-034	11.0.0.0	NV8500 3Gig SDI 18 COAX OUT (EM0785-02, SV0825-11)
<input checked="" type="checkbox"/>	<input checked="" type="checkbox"/>	IOXM-LO-043	8.0.0.0	NV8500 3Gig SDI EMB 16 COAX OUT (EM0815-20, SV1036-08)
<input checked="" type="checkbox"/>	<input checked="" type="checkbox"/>	IOXM-LO-044	8.0.0.0	NV8500 3Gig SDI EMB 16 COAX OUT (EM0815-20, SV1036-08)
<input checked="" type="checkbox"/>	<input checked="" type="checkbox"/>	IOXM-LO-045	8.0.0.0	NV8500 3Gig SDI EMB 16 COAX OUT (EM0815-20, SV1036-08)
<input checked="" type="checkbox"/>	<input checked="" type="checkbox"/>	IOXM-LO-046	8.0.0.0	NV8500 3Gig SDI EMB 16 COAX OUT (EM0815-20, SV1036-08)

Select All Select If Needs Update Select None Select... Update only if versions are different

Each column in the table provides the following options or information:

Column	Description
Update	Check the check box to select the module for updating. (This is just to select the module. Checking the box does not perform the update.)
Needs Update	A check mark appears in the check box when a different version of the firmware exists for a particular module and updating is needed. Modules for which this box is checked show red text.
Name	Type and location of the module being updated. (See Nomenclature on page 50.) Note: if the CPLD or ROM displays in red, the chip must be updated, but cannot be updated through MRC. Contact Miranda Technical Support
Version	The version of the firmware currently loaded in the module.
Description	A general description of the module, which may include its part number, router model, signal type, or function. (See Nomenclature on page 50.)

Choosing a Firmware file

When it becomes necessary to update your router’s firmware, your Miranda service technician will send you a .rf file with new firmware. Store the .rf file in your PC’s file system. When you perform the firmware update, a copy of the firmware is stored in the CF card on the router’s control card. The CF card will store up to 5 recent versions of the firmware. It will also store the names of all previous versions. If you ever want to revert to a previous version, you can choose one of the previous versions available.

To select a firmware file, click ‘Choose’ at the upper right corner of the ‘Firmware’ page. The ‘Choose Router Firmware’ dialog appears. There are two choices in the dialog:

- Used on this control card.
- All available.

‘Used on This Control Card’ Option

The ‘Used on this Control Card’ option lists all previous versions, available or unavailable, on the CF card:

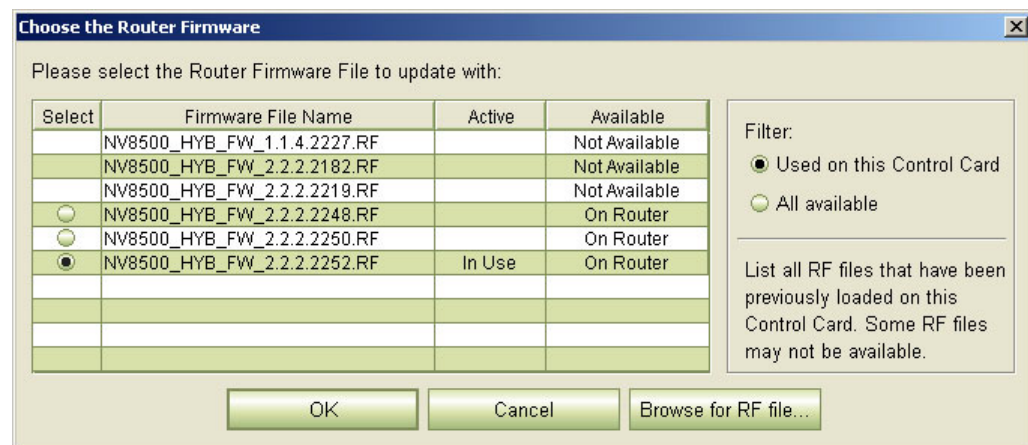

You can choose any that is listed as “on router.” Click the radio button in the ‘Select’ column to do so. Then click ‘OK’.

'All Available' Option

If your intention is to install new firmware, choose 'All Available' and click the 'Browse for RF file ...' button to navigate to the folder that holds your new .rf file. Select that file.

The file now appears in the list and its availability now reads "MRC Cache."

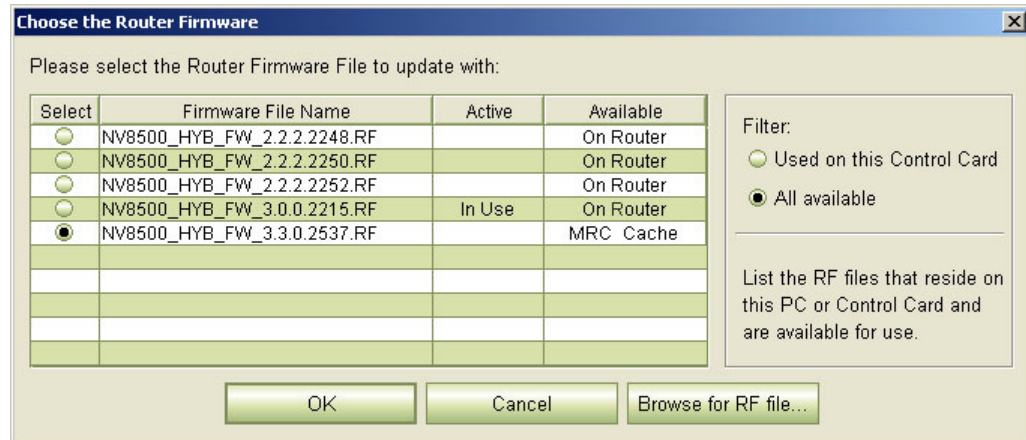

Click the radio button in the 'Select' column for the new firmware to select it. Then click 'OK'.

The phrase "In Use" in the 'Active' column indicates which firmware is currently active in the control card.

You could also choose any of the earlier firmware files listed if you wanted to revert to a previous firmware version.

The 'Available' Column

Five different messages can appear in the 'Available' column of the 'Choose the Router Firmware' dialog. The messages concern the availability of .rf files. This is what they mean:

- Not Available
You (or someone) had once used MRC to install this .rf file, but the file cannot be found in known locations.
- On Router
The .rf file is located in the flash memory of the router's control card. This message is typical of .rf files that have been recently uploaded to the control card but are not available on your PC. (They might be available on someone else's PC.)
- On PC
The .rf file is located on your PC. This message is typical of .rf files that you are about to upload.
- MRC Cache
The .rf file is located in MRC's cache (on your PC). This message is typical of .rf files that you have recently uploaded to the control card, but are not — for whatever reason — in the flash memory of the router's control card.

- MRC & Router

The .rf file is located both in MRC's cache (on your PC) and in the flash memory of the router's control card. This message is typical of .rf files that you have recently uploaded to the control card.

Context Menu

When you have chosen the 'All Available' option, the dialog has a context menu. The context menu has a single command 'Delete from RF Cache'. This command is enabled for .rf files present in MRC's .rf file cache (on your PC). If you want to delete a file from the cache, right-click a row in the list of .rf files that reads 'MRC Cache' or 'MRC & Router' in the 'Available' column:



Click the 'Delete from RF Cache' command. Respond 'Yes' to the confirmation message:

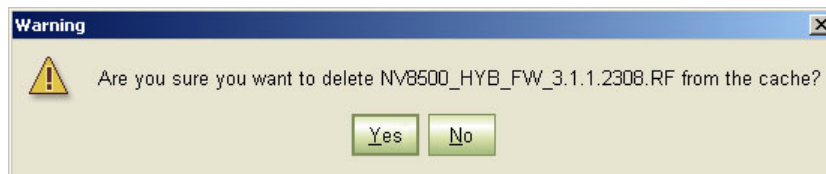

Updating Firmware

A large router can have hundreds of modules. Selecting which modules to update can be overwhelming. The 'Firmware' page provides you with several tools that make it easy to select specific firmware. You can choose to update individual modules, all modules, or create a rule to select only modules that match specific parameters.

The page has 4 selection buttons:

- 'Select All' — selects all modules.
- 'Select None' — deselects all modules
- 'Select if Needs Update' — Selects only those modules that need updates.
- 'Select . . .' — Select modules by criterion. (This button opens a dialog in which you create a "rule", that is, specify the criterion.)

Selecting modules does not perform the update. You must press the 'Update Firmware' button at the bottom of the page to start the update of selected modules:



Modules can take a significant amount of time to update. MRC shows a progress bar (percentage complete) for modules that are updating.

Creating a Module Selection Rule

Click the 'Select . . .' button to open a dialog in which to create a rule for selecting modules. A rule consists of one or more matching expressions. A module becomes selected either when it matches *any* or when it matches *all* of the expressions. Only those modules that match the rule are selected.

The dialog contains one or more rows of entry fields. Each row has 3 entries that form an expression:

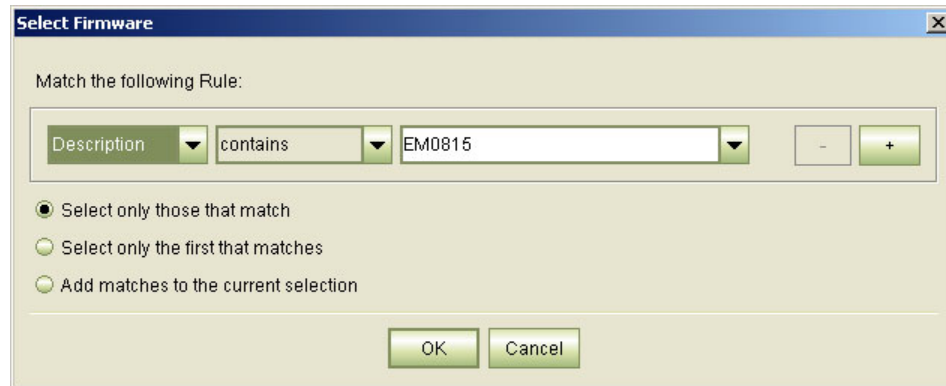

The first entry field is a drop-down list in which you can select a target for matching. The targets are names of the columns in the firmware table:

- 'Needs Update'
- 'Name'
- 'Version'
- 'Description'
- 'Firmware'

The second entry is a drop-down list of matching behaviors. The third entry is the pattern to match. In many cases, this is a text string that you can type. In most cases, the behavior is either "contains" or "does not contain." In the preceding illustration, the matching rule is

Description contains "EM0815"

Using this expression, modules are selected when their description field contains the string "EM0815".

The patterns and matching behaviors differ when you select different targets. For instance, if you select 'name' instead of 'Description' for the target, the pattern drop-down list displays entries from the 'Name' column.

You can add additional matching expressions by clicking the “+” box in the dialog. You can delete a specific expression by clicking the “-” box in its row. When you have more than one expression, the rule changes appearance slightly:

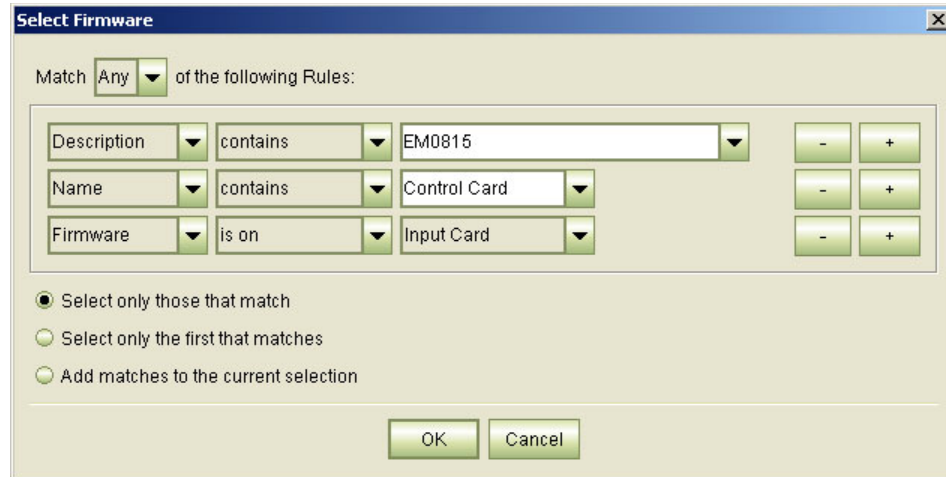

An additional drop-down menu appears where you may specify that the rule applies when a module matches *any* expression or when it matches *all* the expressions.

In all cases, when you click OK, MRC performs the selection that you specify. You are free to perform another selection if you make a mistake. MRC does not execute the update until you click the 'Update Firmware' button at the bottom of the 'Firmware' page.

How To Create a Selection Rule

- 1 Open the 'Firmware' page.
- 2 Click 'Select ...'. The 'Select Firmware' dialog appears:

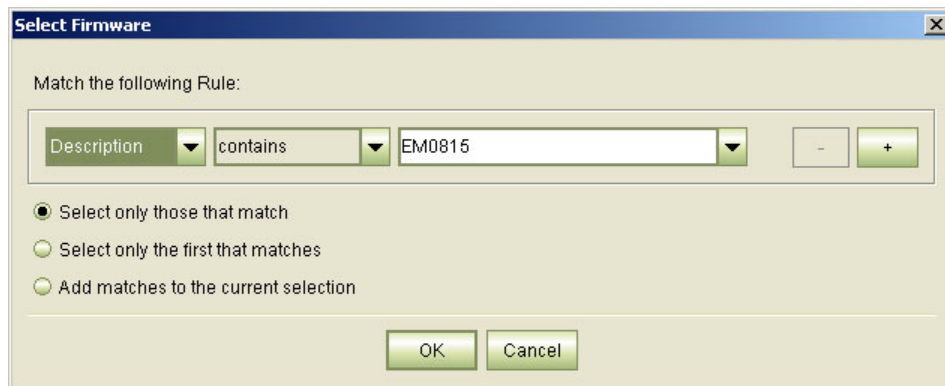

The first drop-down list is the target. The second drop-down list is the behavior. The third drop-down list (or entry field) is the pattern.

- 3 Select a target, behavior, and enter a pattern. Click the plus sign (+) to add a row and select another parameter, action, and term. To remove a row, click its minus sign (-).

The following is a list of targets and accompanying behaviors:

Target	Action	Meaning
Needs Update	is checked is not checked	Generate a match if the module has (or does not have) a check mark in the 'Needs Update' column.
Name	contains does not contain	Generate a match if the name of the module contains (or does not contain) the text string you type.
Version	contains does not contain	Generate a match if the version of the module contains (or does not contain) the selected version. You can specify a substring as the pattern.
Description	contains does not contain	Generate a match if the description field of the module contains (or does not contain) the selected text pattern. You can specify a substring as the pattern.
Firmware	is on is not on	Generate a match if the module is of the type you choose as the pattern: that is, a control card, an input card, an output card, monitor card, or a crosspoint card.

- 4 Choose how the modules that match the rule are selected. Because the choices are "radio buttons," you can select only one option:

Method	Description
Select only modules that match	Only modules that match the rule are selected. This the default method.
Select only the first module that matches	Only the first module that matches the rule is selected.
Add matches to current selection	Any modules that match a (new) rule are added to the previously selected modules.

- 5 Click **OK**.

How To Update Firmware

- 1 Go to the 'Firmware' page. From the **Control Cards** table at the bottom of the page, click a "radio button" to select a control card. Be certain it is the control card you want.
When you select a control card, MRC lists, in the upper part of the page, all the modules of the router frame in which the control card is situated.
- 2 In the 'Router Firmware File' region click **Choose** to locate and select the firmware file you want to use for the update. (Its file extension is .rf.)

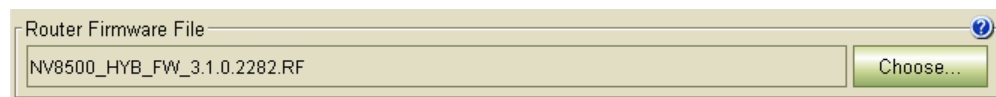

The 'Choose New Firmware' dialog appears.

Click the 'Browse for RF file . . .' button to locate a new firmware file. Then choose the firmware file from the list. (You can choose an earlier version of firmware stored on the control card if you want.)

See [Choosing a Firmware file](#) on page 30 for more information.

- 3 In the 'Current Firmware Versions' region, select all the modules you want to update at one time.
 - Check individual check boxes in the 'Update' column,
 - Or, click **Select All**,
 - Or, click **Select If Needs Update** to select only modules with a check mark in the 'Needs Update' column,
 - Or, click **Select . . .** to select modules by a criterion,
 - Or, click **Select None**. (Note that when no modules are selected, an update cannot occur.)
- 4 (Optional) To force all selected modules to be updated, uncheck the 'Only update if versions are different' check box. When this option is checked, modules are updated only when the firmware version is different from the firmware currently loaded on the module.
- 5 Click **Update Firmware** (at the bottom of the page). MRC starts the update of all selected modules.

One or more progress bars appear in the 'Description' field of modules being updated. When a module is completed, "Update succeeded" appears in place of the progress bar.

When the update of all modules is complete, MRC displays a log of the update:

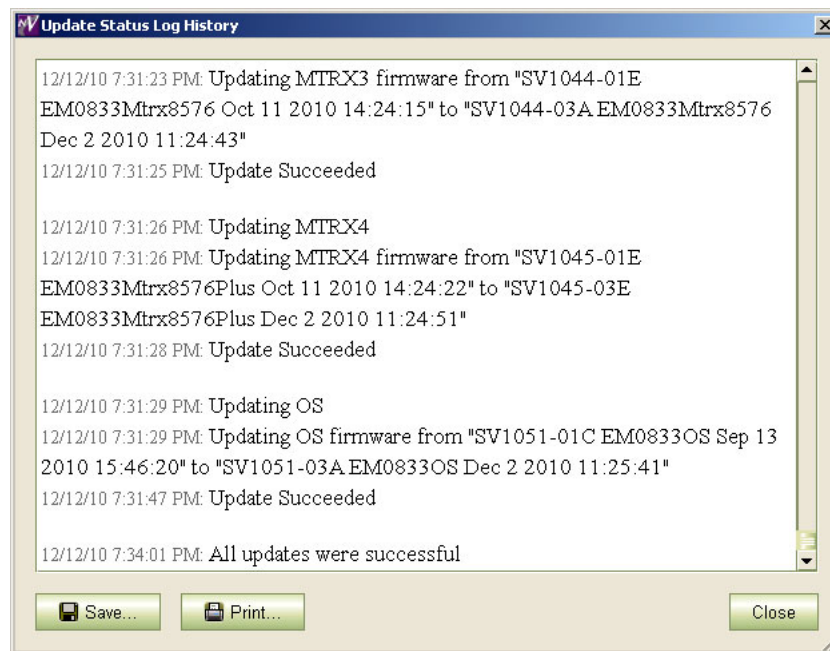

Note

If MRC fails to update certain cards, try the update again for those cards. If the update fails repeatedly, contact [Miranda Technical Support](#).

Note

In practice, it is advisable to update each control card first, and then update IOXM cards.

- 6 Repeat this procedure for each control card of the router. (An expanded NV8576-Plus typically can have 4 control cards, 2 in each frame.)

Do not repeat this procedure of IOXM cards. It is not necessary and very time-consuming.

Viewing and Saving Update Logs

Every time a module's firmware is updated, a description of the update is logged in the MRC database. To view a log of past updates, click **View Past Update Logs** (at the bottom of the 'Firmware' page). The button remains greyed out (i.e., inactive) until you have performed an update that can be logged.

How to View and Save an Update Log

- 1 Go to the 'Firmware' page.
- 2 Click **View Past Update Logs**, at the bottom of the page. The 'Update Status Log History' window appears.
- 3 (Optional) To print the currently displaying log, click **Print**.
- 4 Click **Save**. The 'Save' window appears.
Click **Browse** to specify where you want to save the file, enter a file name, and then click **Save** to save the file and close the window.
- 5 Click **Close**.

Router Levels Page

Creating levels is an important part of the configuration process. Router control systems use level information to communicate with the router and manage the crosspoint connections. To view and set router levels, use the 'Router Levels' page.

Note

The levels governed by this page are termed "physical levels" or "partitions" in other software. The "physical" levels defined in this page must also be defined identically in the router's description in NV9000-SE Utilities.

Further, NV9000-SE Utilities defines what are called "virtual" levels. The levels governed by this page are *not* "virtual" levels.

(Physical) levels are boundaries within the switching matrix that organize switching within the router. Each level is assigned one or more signal types that represent the signals being switched within that level. Signals can be switched only within the same level. The signal types assigned to the level must match the actual signals being routed.

Remember that every router configuration must have at least one level and signals can be switched only within a level, not between levels.

It is in the 'Router Levels' page that you can specify certain features of the NV8500 hybrid routers:

- The null audio source.
- The *basic* pass-through audio source.
- Sixteen audio sources for *extended* pass-through.

See [Special Audio Sources](#) on page 43.

Using the Router Levels Page

This is a typical 'Router Levels' page:

The screenshot shows the 'Router Levels' configuration page with three main sections:

- Special Audio Sources:** This section includes checkboxes for 'Null Audio Source' (checked) and 'Pass Thru Audio Source' (checked). Below these are input fields for source numbers (144 and 143). A 'Pass Thru Shuffle Audio Source' table is also present, listing 16 channels and their corresponding source numbers.
- Physical Levels:** This section contains a table with columns for Level, Physical Input Start, Physical Input End, Controller Source Start, Controller Source End, Physical Output Start, Physical Output End, Controller Destination Start, Controller Destination End, and Signal Type. The table lists levels 1 through 6 with their respective physical and controller parameters and signal types like Digital Video, Asynchronous AES, Monitor, Synchronous Audio, and Synchronous Stereo Audio.
- Network Frame Summary:** This section has tabs for 'Control Cards' and 'Network Levels'. It displays a table with columns for Edit, Online, Name, Type, IP Address, and Expansion. The table lists various control cards and their configurations, including TS SQA NV8144, QA NV8280_211, QA_NV8576+, gh QA_NV8576+, and Unicon3 MRK 222.

It has 3 main sections:

- Special audio sources.

This section allows you to define the following items:

- The null audio source.
- The basic pass-through audio source.
- Sixteen audio sources for extended pass-through.

These are discussed in [Special Audio Sources](#) on page 43.

- ▲ The information displayed in the special audio sources section changes if you have selected a 'Synchronous Stereo Audio' level of an NV8500 series hybrid router.
- ▲ For other routers, this section is disabled.

- Physical level list.

Use this section to define the physical levels of your router.

- Network Frame Summary.

This section has two tabs: 'Control Cards' and 'Network Levels'. Use the 'Control Cards' tab to select a router control card for the router you want to configure. (The 'Network Levels' tab provides information only.)

Network Frame Summary

This section has two tabbed lists and two important buttons:

The screenshot shows a window titled "Network Frame Summary" with two tabs: "Control Cards" (selected) and "Network Levels". Below the tabs is a table with the following data:

Edit	Online	Name	Type	IP Address	Expansion
<input type="radio"/>	Active	NV8140	NV8140	192.168.102.107	Stand Alone
<input type="radio"/>	Active	NV8256+	NV8256 Plus	192.168.102.138	Stand Alone
<input type="radio"/>	Active	Unicon3 MRK 143	NV8576 Plus	192.168.102.143	Expanded - Main
<input type="radio"/>	Active	IOXM II 8280	NV8280	192.168.102.152	Stand Alone
<input type="radio"/>	Active	Chris NV8144	NV8144	192.168.102.156	Stand Alone
<input checked="" type="radio"/>	Active	Stu 8576	NV8576	192.168.102.190	Stand Alone
<input type="radio"/>	Active	STC OL NV8576 F	NV8576 Plus	192.168.102.210	Expanded - Expansion

At the bottom of the window are two buttons: "Refresh Summary" and "Update Control Card".

Use the 'Control Cards' tab to select a router control card for the router you want to configure. (The 'Network Levels' tab provides information only. Its use is not required to perform any tasks.)

The buttons at the bottom of the section are:

- Refresh Summary
Click this button to ensure that the list of control cards contains current information.
- Update Control Card
Click this button after you have made changes to the configuration of the selected router control card.

Physical Levels

To view or set levels, select a control card in the 'Control Cards' table of the router frame summary.

When you have selected a control card, MRC displays its current level settings in the 'Crosspoint Ranges for Level Settings' table in the middle of the page.

An invalid signal type can exist only in control cards configured with older versions of MRC.

See [Adding and Updating Levels](#) on page 41.

This illustration shows typical levels for a hybrid NV8280.

Level	Physical Input Start	Physical Input End	Controller Source Start	Controller Source End	Physical Output Start	Physical Output End	Controller Destination Start	Controller Destination End	Signal Type
1	1	576	1	576	1	1152	1	1152	Digital Video
2	1	9216	1	9216	1	18432	1	18432	Synchronous Audio
3	1	4608	1	4608	1	9216	1	9216	Synchronous Stereo Audio

The table's columns provides the following information:

Column	Description
Level	Number assigned to the level. A unique number is automatically assigned. If you change the level, keep in mind that the level numbers must all be different.
Physical Input Start	The physical input connector at which the level starts.
Physical Input End	The physical input connector at which the level ends.
Controller Source Start	The logical port number at which the level begins, for sources.
Controller Source End	The logical port number at which the level ends, for sources. This number is calculated. You cannot change it.
Physical Output Start	The physical output connector at which the level starts.
Physical Output End	The physical output connector at which the level ends.
Controller Destination Start	The logical port number at which the level begins, for destinations.
Controller Destination End	The logical port number at which the level ends, for destinations. This number is calculated. You cannot change it.
Signal Type	The signal type to be supported by the level. See Signal Types on page 133.

Note: strictly speaking the “controller source” numbers and “controller destination” numbers are really *port* numbers in the router control system, not source and destination numbers. *Sources* and *destinations* in the router control system are *aggregates* of router ports, often spanning multiple routers.

Level Types

There are many physical level types (corresponding to *signal types* as the column is labeled in the table). The levels from which you may choose depend on the router you are configuring.

For the NV8500 family routers, these are the available level types:

- Asynchronous AES. Use a partition of this type if your NV8500 router has AES cards installed.
- Digital Video. Use a partition of this type for video signals of any type (e.g., 3Gig, HD, or SD).
- Monitor. Use a partition of this type to support input and output monitoring. (Monitor cards must have been installed in your router.)
- Synchronous Audio. Use a partition of this type for NV8500 hybrid routers. Embedded (and disembedded) audio and MADI signals are supported by this partition type.

- **Synchronous Stereo Audio.** Use a partition of this type if you want to support the switching of stereo pairs. (The 'Synchronous Audio' level supports independent switching of audio channels. (This is called "mono" switching.) You may superimpose a stereo level on a "mono" level; that is, the two levels may overlap).

The range values that specify a stereo partition are half those of a corresponding "mono" partition because, in stereo, the audio channels are paired.

- ▲ If you have defined, and selected, a stereo audio partition, the information displayed in the 'Pass-Thru Shuffle Audio Source' table changes.

Special Case for NV8500 Hybrid Routers

If an NV8500 hybrid router has any MADI cards *and* uses DHP, you must add 40,000 to the MADI port numbers in NV9000-SE Utilities. In addition, you must add 40,000 to the natural audio partition size.

If the natural audio partition is 9216×18432 , then the audio partition for MADI under DHP must be specified as $49,216 \times 58,432$ in NV9000-SE Utilities.

You must *not* add 40,000 to the partition size in MRC.

Adding and Updating Levels

Levels are created by specifying a range of inputs and a range of outputs. A range is denoted by a starting number and an ending number. Inputs and outputs are referenced in two ways: (1) as physical input connections and physical output connections on the router, and (2) as logical ports (supporting sources and destinations) in the router control system.

The physical input and output numbers in the table represent the physical connections on the router. The logical ports in a router control system always map to physical connections, but the numbering might not be the same. For example, the router control system might have port 1 mapped to physical input 17, not physical input 1.

For information about router control system source and destination numbering, refer to your router control system's documentation.

IMPORTANT

Every control card in a router must be configured separately, but identically.

The levels defined in MRC must match the levels defined in your router control system.

If you change or delete a level in MRC, you must make a corresponding change in the router control system's configuration.

For each level, MRC generates a list of available signal types automatically according to the type of router. These are available in the drop-down lists in the 'Signal Type' column of the table.

(See [Signal Types](#) on page 133.)

How to Create or Update a Level

- 1 Go to the 'Router Level' page. From the **Control Cards** table at the bottom of the page, select a control card. The level data for that control card appear in the 'Crosspoint Ranges for Level Settings' table.
- 2 If you want to add a level, click **Add Level**.



A new row appears in the table (unless the table is already at its maximum size).

- 3 If you are updating a level, locate its table row.
- 4 In the 'Signal Type' entry for that row, select a signal type from the drop-down list. You must do this before setting other parameters. The signal type determines the range of values for the physical inputs and outputs. The signal type options vary according to the router type.
- 5 Enter the remaining parameters for the level. Click in a cell to activate the editable field:

Column	Description
Level	By default, the next sequential number is assigned to a level, starting at 1.
Physical Input Start	The range specified by the start and end values depends on your intentions, but cannot exceed the maximum range of the router.
Physical Input End	
Controller Source Start	The logical port number in the router control system that maps to the physical input starting number.
Controller Source End	The logical port number in the router control system that maps to the physical input ending number. This number is calculated. You cannot change it.
Physical Output Start	The range specified by the start and end values depends on your intentions, but cannot exceed the maximum range of the router.
Physical Output End	
Controller Destination Start	The logical port number in the router control system that maps to the physical output starting number.
Controller Destination End	The logical port number in the router control system that maps to the physical output ending number. This number is calculated. You cannot change it.

- 6 Repeat steps 1–5 for other levels.
- 7 Click **Update Control Card** to send the level information to the control card.



- 8 Each control card must be configured separately and all control cards in the router must have the same level settings.
Repeat this procedure for each control card in the router frame.
Or, copy the control card's configuration to the remaining control card(s) in the router. See [Copy Settings Page](#) on page 69.
- 9 Each control card in the router must be configured separately and identically.
Either repeat this procedure for each control card in the router . . .
Or, finish making all changes to the control card and then copy its configuration to the remaining control card(s) in the router. See [Copy Settings Page](#) on page 69.

Deleting Levels

You can delete levels at any time, but be careful. Heed the following warning:

Every control card in a router must be configured separately, but identically.
The levels defined in MRC must match the levels defined in your router control system.
If you change or delete a level in MRC, you must make a corresponding change in the router control system.

Remember that every router configuration must have at least one level and signals can be switched only within a level, not between levels.

How to Delete a Level

- 1 Go to the 'Router Level' page. From the **Control Cards** table at the bottom of the page, select a control card.
- 2 In the 'Crosspoint Ranges for Level Setting' table, click on the row representing the level to select it. Then click **Delete Level**.



(In the confirmation window, click **YES**.)

- 3 Repeat step 2 for other levels you want to delete.
- 4 Click **Update Control Card** to send the level information to the control card.



- 5 Each control card in the router must be configured separately and identically.

Either repeat this procedure for each control card in the router . . .

Or, finish making all changes to the control card and then copy its configuration to the remaining control card(s) in the router. See [Copy Settings Page](#) on page 69.

Special Audio Sources

- ▲ The special audio sources section of the page applies only to NV8500 hybrid routers, and then only to those hybrid routers that use disembedder/embedder output cards.

The special audio sources are artificial (or fictitious) sources that are recognized, and used, by router firmware to perform special functions.

The special audio sources **do not** produce audio of any kind. What they do is signal to the router control card that it must perform specific operations with regard to embedded audio output.

Because the special audio sources are fictitious, it is recommended, for any of the special audio sources, that you specify one of the unused audio ports in your router. For example, the unused audio ports of a disembedder card in slot 1 are numbered 129–144. (They are included in the port numbering, but there is no circuitry for those ports.) Note that a port committed to a special audio function cannot be used as a normal audio port.

The special audio sources are involved in the logic of disembedder/embedder cards. A card output receives either (1) generated silence, (2) audio from the router's audio matrix, (3) audio disembedded from the video at the output.

Important: the different special audio sources — unless the fields are disabled or blank — must all have different values. The router will still function, but it might not function the way you expect. In such cases, the router's behavior is not easily definable.

Regions of the Special Audio Section

The title of this section is 'Audio Settings for Level':

Channel	Source	Channel	Source
1	129	9	134
2	130	10	135
3	131	11	
4		12	136
5	132	13	137
6	133	14	
7		15	
8		16	138

Fig. 3-1: Special Audio Section

The section has 3 parts that allow you to define the following items:

- The null audio source.
 - The basic pass-through audio source.
 - Sixteen audio sources for extended pass-through.
- ▲ The port numbers in this section must all be unique. You may not have duplicates.

Null Audio Source

When used (by a control panel operator), a “null audio source” lets the router control card know that null audio is required for an audio output (in an embedder or disembedder/embedder output card).

The port you specify as the null audio source **is not** a source of audio. This “null audio source” tells the router to use, instead, *silence* from an internal silence generator.

- ▲ Null audio is generated silence, but is more than just silence because when all the channels of an audio group are null, the group is omitted from the output altogether.

See [Embedded Group Control](#) on page 141 for more information.

How to Specify a Null Audio Source

- 1 Check the 'Null Audio Source' check box. If this box is not checked, the null audio source field is greyed out.
- 2 Enter one of the audio input ports of the hybrid router in the null audio source field. The field actually accepts values in the range [0–65,535] but only valid audio port numbers (e.g., in the range 1–9216) will work properly. We recommend that you specify one of the unused audio ports of the router's disembedder cards (or MAD1 cards). Otherwise, if you specify a normal port, that port cannot be used for any real input.

Uncheck the 'Null Audio Source' check box if you do not want to use null audio.

- 3 Perform other changes in the 'Router Level' page as required and click the 'Update Control Card' button at the bottom of the page.

- ▲ To be usable, the null audio source must also be configured in NV9000-SE Utilities.

Pass-Through Audio Sources

Pass-through audio means audio taken from the video presently routed to the output.

When used (by a control panel operator), a “pass-through audio source” lets the router control card know that pass-through audio is required for an audio output (in an embedder or disembedder/embedder output card).

A port you specify as a pass-through audio source **is not** a source of audio. When a control panel operator chooses a pass-through audio source, what he or she means is “use the audio from the video routed to the output.”

There are two forms of “pass-through” audio:

- *Basic*—governs all 16 audio channels of a video source as a unit.

The title of this field is ‘Pass-Thru Audio Source’.

When a control panel operator specifies this audio source, all 16 audio channels of the disembedder/embedder output are taken from the video routed to that output.

Under *basic* pass-through, the mapping of audio channels from the video source to the output is identity. That is, audio channel n goes to output channel n , where $1 \leq n \leq 16$.

- *Extended*—allows you to specify 16 individual pass-through audio sources, one for each audio output channel.

The title of this region is ‘Pass-Thru Shuffle Audio Source’.

- ▲ The appearance and meaning of the fields of this region change when you select a ‘Synchronous Stereo Audio’ level. See [Stereo vs. Mono](#), following.

Under *extended* pass-through, the mapping of audio channels from the video source to the output is any-to-any. That is, the source channels can be shuffled.

There is no check box that enables the pass-through audio sources of this section. Leave blank the fields for those channels for which you do not want a pass-through audio source.

When a control panel operator specifies one of the pass-through audio sources that you specify in this region, the audio source channel specified by the pass-through selection is sent to the selected audio channel of the output.

For example, if, as in Figure 3-1, audio source 131 is specified for channel 3, when a panel operator “takes” audio port 131 to the output, what happens is that audio channel 3 of the video routed to the output is taken (or “passed through”) to the chosen audio channel of the output.

The disembedder on the output cards makes those audio channels available. The multiplexer on the output card does the individual channel selection.

- ▲ To be usable, any pass-through audio sources you define must also be configured in NV9000-SE Utilities.

See [Pass-Through Sources](#) on page 142 for additional information.

Stereo vs. Mono

The format of the ‘Pass-Thru Shuffle Audio Source’ table changes when you have selected a ‘Synchronous Stereo Audio’ level.

If you have *not* selected a stereo level, or if you have none defined, the table has 16 entries as shown here:

Channel	Source	Channel	Source
1	129	9	
2		10	130
3	131	11	
4		12	132
5	133	13	
6		14	134
7	135	15	
8	136	16	

If you *have* selected a defined stereo level, only the first 8 entries of the table are enabled:

Channel	Source	Channel	Source
1 & 2	129	N/A	
3 & 4		N/A	130
5 & 6	131	N/A	
7 & 8		N/A	132
9 & 10	133	N/A	
11 & 12		N/A	134
13 & 14	135	N/A	
15 & 16	136	N/A	

Only the left 2 columns applies to Stereo Levels

Table entries 9–16 are disabled. Entries 1–8 provide pass-through audio support for 8 stereo pairs. Channels 1 and 2 are paired, channels 3 and 4 are paired, and so on.

The pass-through ports you specify are specified according to the mono port numbering.

Any ports you have used for table entries 9–16 (for mono pass-through) are disabled for stereo pass-through.

How to Specify a *Basic* Pass-Through Audio Source

- 1 Check the 'Pass-Thru Audio Source' check box. If this box is not checked, the pass-through audio source field is greyed out.
- 2 Enter one of the audio input ports of the hybrid router in the pass-through audio source field. The field actually accepts values in the range [0–65,535] but only valid audio port numbers (e.g., in the range 1–9216) will work properly. We recommend that you specify one of the unused audio ports of the router's disembedder cards (or MAD1 cards). Otherwise, if you specify a normal port, that port cannot be used for any real input.
Uncheck the 'Pass-Thru Audio Source' check box if you do not want to use basic pass-through audio.
- 3 Perform other changes in the 'Router Level' page as required and click the 'Update Control Card' button at the bottom of the page.

How to Specify *Extended* Pass-Through Audio Sources for a Mono Partition

- 1 Ensure that you have not selected a 'Synchronous Stereo Audio' partition.
- 2 Go to the 'Pass-Thru Shuffle Audio Source' table. Take note of its contents. The table has 16 entries, each corresponding to an audio output channel (of any output of any disembedder/ embedder card in the router). The channels are identified.

- 3 Choose a channel. Enter one of the audio input ports of the hybrid router in the 'Source' field for that channel. We recommend that you specify one of the unused audio ports of the router's disembedder cards (or MADI cards). Otherwise, if you specify a normal port, that port cannot be used for any real input.
The port must be in the range of the 'Synchronous Audio' inputs. The field must not be blank.
Leave the 'Source' field blank if you do not want to use pass-through audio for that channel.
- 4 Repeat step 3 for any other audio channels for which you want pass-through audio.
- 5 Perform other changes in the 'Router Level' page as required and click the 'Update Control Card' button at the bottom of the page.

How to Specify *Extended* Pass-Through Audio Sources for a Stereo Partition

- 1 Select a 'Synchronous Stereo Audio' partition.
- 2 Go to the 'Pass-Thru Shuffle Audio Source' table. Take note of its contents. The table has 8 entries, on the left side of the table, each corresponding to a (stereo) pair of audio output channels (of any output of any disembedder/embedder card in the router). The channel pairs are identified.
- 3 Choose a channel pair. Enter one of the audio input ports of the hybrid router in the 'Source' field for that channel. The field actually accepts values in the range [0–65,535] but only valid audio port numbers (e.g., in the range 1–9216) will work properly. We recommend that you specify one of the unused audio ports of the router's disembedder cards (or MADI cards). Otherwise, if you specify a normal port, that port cannot be used for any real input.
Leave the 'Source' field blank if you do not want to use pass-through audio for that channel.
- 4 Repeat step 3 for any other channel pairs for which you want pass-through audio.
- 5 Perform other changes in the 'Router Level' page as required and click the 'Update Control Card' button at the bottom of the page.

Input Attributes Page

The 'Input Attributes' page applies only to NV8500 hybrid routers.

The page allows you to specify, for any video input, whether the embedder of any output to which the input is routed is to be forced ON.

Normally, the audio embedder of an output is enabled or disabled automatically according to internal switching rules. See [Switching "Rules"](#) on page 139.

The table in this page gives you a choice for each input.

- Force embedder ON.
- Use switching rules.

Caution: if your router control system uses DHP to control the router, make sure that the setting is 'Use Switching Rules' for all inputs.

This is a view of the page for an expanded NV8576-Plus:

The screenshot displays the 'Input Attributes' configuration page. It features a table with 18 rows, each representing an input. The columns are 'Input', 'Output Embedder Attributes', 'Location', and 'Module'. The 'Output Embedder Attributes' column contains dropdown menus with options like 'Use Switching Rules' and 'Force Embedder ON'. The 'Location' column shows 'Main: UI-001' for inputs 1-9 and 'Main: UI-002' for inputs 10-18. The 'Module' column lists 'NV8500 3Gig COAX 8' for all inputs.

Below the table is an 'Input Range' section with 'Start' (1) and 'End' (1152) fields, and 'Read Inputs' and 'Read All' buttons. To the right is a diagram of the router's front panel with 'Router Front' selected.

At the bottom is the 'Network Frame Summary' section, which includes tabs for 'Hybrid Routers', 'Network Levels', and 'All Control Cards'. The 'Hybrid Routers' tab is active, showing a table with columns: Edit, Online, Name, Type, IP Address, and Expansion.

Edit	Online	Name	Type	IP Address	Expansion
<input type="radio"/>	Active	Unicon3 MRK 133	NV8576	192.168.102.133	Stand Alone
<input type="radio"/>	Standby	Unicon3 MRK 143	NV8576	192.168.102.143	Stand Alone
<input type="radio"/>	Active	Master(P)	NV8576 Plus	192.168.102.190	Stand Alone
<input type="radio"/>	Standby	QA_8576+	NV8576 Plus	192.168.102.211	Expanded - Main
<input checked="" type="radio"/>	Active	QA_8576+	NV8576 Plus	192.168.102.214	Expanded - Main
<input type="radio"/>	Active	Unicon3 MRK 222	NV8576	192.168.102.222	Stand Alone
<input type="radio"/>	Standby	Unicon3 MRK 223	NV8576	192.168.102.223	Stand Alone

Buttons for 'Refresh Summary' and 'Update Control Card' are located at the bottom of the summary section.

The page has two regions. At the bottom is a 'Network Frame Summary' that contains tabbed tables. In the 'Hybrid Router' table, you can select the control card of a router to configure.

The upper region contains a table of input ports and their settings and a graphic image of the router, front or back. If you select an input in the table, the input card is highlighted (in yellow) in the graphic. You might have to scroll the graphics window to see the selection.

Choose a radio button below the graphic to switch between front and back views.

The table shows the following information for each input:

Column	Description
Input	The video input port number.
Output embedder Attributes	A drop-down menu exists for each input: There are two choices in the menu: 'Force embedder ON' — force the output's embedder to be enabled. 'Use Switching Rules' — use the embedder's automatically generated state. Note that embedders in disembedder/embedder output cards are always on.
Location	The input slot in which this input is found.
Module	If a slot is empty, this field is blank. Otherwise, the field shows the type of the card in the slot, for that input.

Note

If you hover your mouse over an input in the input list, MRC displays a small information window, showing the input card's slot number and the audio ports that would correspond to the input if the input slot held a disembedder card:

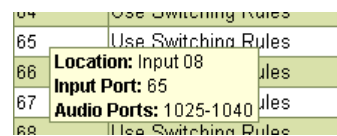

The audio ports display regardless of whether the input card is a standard card, disembedder card, or MAD I input card.

Card Selection

Use standard click, shift-click, and control-click methods to make input port selections in the input list.

You can also click an input card in the drawing (front or rear) to select it. When you do so, the card is highlighted in yellow and the first input of that card is highlighted in the input list.

Clicking an input card causes any previously selected inputs to become unselected.

Caveats

This table treats the entire input space of the router uniformly. Where there are disembedder input cards and MAD I input cards in the router, some of the video input ports listed *do not exist* in the router. For empty slots, obviously, the input ports do not exist.

It is harmless to assign a value to a non-existent port (and MRC lets you do it) but you should not forget that some of the ports listed might not exist in the router.

Nomenclature

The 'Location' column uses abbreviations for card locations. This is what they mean:

- I-*nnn* — input card in slot *nnn* (for NV8144s and NV8280s)
- LI-*nnn* — input card in slot *nnn* of the lower bay (for NV8576s and NV8576-Pluses)
- UI-*nnn* — input card in slot *nnn* of the upper bay (for NV8576s and NV8576-Pluses)
- Main: LI-*nnn* — input card in slot *nnn* of the lower bay of the main frame (for expanded NV8576-Pluses)
- Main: UI-*nnn* — input card in slot *nnn* of the upper bay of the main frame (for expanded NV8576-Pluses)
- Expansion: LI-*nnn* — input card in slot *nnn* of the lower bay of the expansion frame (for expanded NV8576-Pluses)
- Expansion: UI-*nnn* — input card in slot *nnn* of the upper bay of the expansion frame (for expanded NV8576-Pluses)

The 'Module' column also uses abbreviations. (See [Nomenclature](#) on page 50.)

Context Menu

You can change input port settings on an individual basis. Use standard click, shift-click, and control-click methods to make your selection.

You can also select any number of inputs and use the context menu to modify all the selected inputs at one time. This is the context menu:



In the context menu, you can (1) select all inputs or (2) select all inputs of a particular type.

When you have selected one or more inputs, use the 'Set selection: Output embedder' command, and its submenu, to set their values.

Output Attributes Page

A "switch point" is the point in time in which a video output will be switched from its current input to a new input. Switching of audio associated with the video signal is synchronized with the video switch. Different video and audio formats require different switch points.

You can set switch point parameters for individual outputs in the 'Output Attributes' page.

The attributes table controls the type of switch point, but not the actual moment in time of the switch, relative to the reference signal. Diagnostic equipment or specialized software is required for that.

The 'Output Attributes' page also has reference signal controls. (Switch points are affected by the reference signals.)

Reference signals are connected at reference connections on the router frame. Video reference connects at two ports labeled VIDEO REF1 and VIDEO REF2. These connectors can receive the

same signal or different signals. If they receive the same signal, the references are considered *redundant*. Otherwise they are *dual* references.

(See [Redundant and Dual Video References](#) on page 139.)

Audio reference connects at two ports labeled AES REF1 and AES REF2. One or both connections are connected to a stable AES source at 48 kHz (48,000 samples per second). If AES reference is applied to both connectors, the connection is redundant.

For more information on reference connections, see the router's documentation.

Additional Information about Video and AES Reference

For information about output attribute settings and how to set them, review the following material:

- [Video Fields and Frames](#) on page 135.
- [About Vertical Timing](#) on page 135.
- [SMPTE Standards for Switch Point](#) on page 136.
- [External References and Switch Point Configurations](#) on page 136.
- [Redundant and Dual Video References](#) on page 139.

Using the Output Attributes Page

To view or modify output attributes of video outputs in a router, select a control card for that router in the 'Video Routers' table at the bottom of the page.

The output attributes page cannot be used for the expansion frame of an expanded router. Use the corresponding main frame to access the outputs of the expansion frame.

When you select a control card, MRC presents (1) reference options and (2) a table of outputs for the router. For the sake of discussion, we call this the attributes table.

This is a sample showing the data for an NV8280:

Output	*Re-clock / Bypass	HD / SD
1	Use Re-clocker	Switch on SD Line
2	Use Re-clocker	Switch on HD Line
3	Use Re-clocker	Switch on SD Line
4	Use Re-clocker	Switch on HD Line
5	Use Re-clocker	Switch on SD Line
6	Use Re-clocker	Switch on HD Line
7	Use Re-clocker	Switch on SD Line
8	Use Re-clocker	Switch on HD Line
9	Use Re-clocker	Switch on SD Line
10	Use Re-clocker	Switch on HD Line
11	Use Re-clocker	Switch on SD Line
12	Use Re-clocker	Switch on HD Line
13	Use Re-clocker	Switch on SD Line
14	Use Re-clocker	Switch on HD Line
15	Use Re-clocker	Switch on SD Line
16	Use Re-clocker	Switch on HD Line
17	Use Re-clocker	Switch on SD Line
18	Use Re-clocker	Switch on HD Line
19	Use Re-clocker	Switch on SD Line
20	Use Re-clocker	Switch on HD Line
21	Use Re-clocker	Switch on SD Line

AES Reference Options

A check in the checkbox in this region means that an external AES reference must be present for proper switching. If the box is unchecked, an external AES is not required:

If an AES reference is not present, the router uses its video reference. For NV8500 series routers, an external AES reference is generally not required.

Dual Video Reference Options

In this region of the page, you can choose between redundant or dual video reference. The contents of the region differ, depending on which you choose:

Redundant Reference

Dual Reference

You can choose among 3 reference rates. If you choose redundant reference, the reference rate applies to both video reference ports. If you choose dual reference, you can have different rates for the two ports.

For your router to work properly, your settings in this page and the actual video reference connections must match.

See [Redundant and Dual Video References](#) on page 139.

Output Range

The items in this region act as a filter to limit the amount of information displayed in the attributes table at the right of the window:

There are two buttons in this region:

- **Read Outputs**
Specify a start and end value, then click this button. MRC displays the outputs in the range indicated by the start and end values.
- **Read All**
Click this button to display parameters for all outputs in the router. MRC shows the default output range to the left of this button.

The Attributes Table

The attributes table shows the following information for each output displayed:

Column	Description
Output	The output port number.
*Re-clock/Bypass	There are two choices in the drop-down menus in this field: 'Use Re-clocker' and 'Bypass Reclocker'. Bypassing the output's reclocker retains the input signal's current rate. This option is available for standard SD and HD outputs. This column affects only "Super Wide Band" outputs. This option is available for standard outputs. Hybrid re-clockers cannot be bypassed. (The drop-down menu for hybrid reclockers is disabled, and this is indicated by the down arrow being dimmed.)
HD / SD	There are two choices in the drop-down menus in this field: 'Switch on SD Line' and 'Switch on HD Line'. Choose Switch on SD Line for SD (or analog video) signals. Choose Switch on HD Line for HD signals.

If you are configuring an NV8256 or an NV8256-Plus, the attributes table has one additional column:

Output	*Re-clock / Bypass	Field / Frame	HD / SD
1	Use Re-clocker ▼	Switch on Field Boundary ▼	Switch on HD Line ▼
2	Use Re-clocker ▼	Switch on Field Boundary ▼	Switch on HD Line ▼
3	Use Re-clocker ▼	Switch on Field Boundary ▼	Switch on HD Line ▼
4	Use Re-clocker ▼	Switch on Field Boundary ▼	Switch on HD Line ▼
5	Use Re-clocker ▼	Switch on Field Boundary ▼	Switch on HD Line ▼
6	Use Re-clocker ▼	Switch on Field Boundary ▼	Switch on HD Line ▼
7	Use Re-clocker ▼	Switch on Field Boundary ▼	Switch on HD Line ▼
8	Use Re-clocker ▼	Switch on Field Boundary ▼	Switch on HD Line ▼
9	Use Re-clocker ▼	Switch on Field Boundary ▼	Switch on HD Line ▼
10	Use Re-clocker ▼	Switch on Field Boundary ▼	Switch on HD Line ▼
11	Use Re-clocker ▼	Switch on Field Boundary ▼	Switch on HD Line ▼

That is the 'Field/Frame' column. In the fields of this column, you specify whether the individual router outputs are to switch on a field or frame basis.

See [Video Fields and Frames](#) on page 135.

Note

If you hover your mouse over an output in the attributes table, MRC displays a small information window, showing the output card's slot number and the audio ports that would correspond to the output if the output slot held an embedder card:

10	Use Re-clocker
11	Use Re-clocker
12	Location: Output 01 Output Port: 11 Re-clocker
13	Audio Ports: 161-176 Re-clocker
14	Use Re-clocker

The audio ports display regardless of whether the output card is a standard card, embedder card, or MAD I output card.

Output Attributes Context Menu

In addition to the drop-down menus for individual outputs, the attributes table provides a context menu. Right-click anywhere within the table to display the context menu:

Select All
Set selection: Re-clock / Bypass ▶
Set selection: HD / SD ▶

The context menu lists 2 settings: **Reclock/Bypass** and **HD/SD**.

To apply a setting to a single output, right-click on the output and then choose a setting from the context menu.

To apply a setting to all outputs, right-click anywhere in the list of outputs and click **Select All**. Then make your settings.

For a description of each setting, see [How to Configure Output Attributes](#) on page 55.

Configuring and Updating Output Attributes

Switch points can be configured for video outputs. MRC displays only fields that apply to the type of signals a specific router can switch.

To ensure proper switching of video signals require that the router be connected to a video reference source.

A switch point is accurate only if the input signals to the router are (vertically) timed to the applied reference signals. The router calculates an output's switch point using the reference signal: line 10 for SD or analog signals at 525i, line 6 for SD or analog signals at 625i, and line 7 for all HD and 3Gig standards.

For example, if an input's line 1 is displaced 100 lines from the reference, the switch occurs at line 110 (SD, 525i), 106 (SD, 625i), or 107 (HD or 3Gig). However, because of automatic timing in downstream devices the need for precise timing of sources at the router inputs is usually unnecessary.

After you have initially configured a number of switch points, you can update the router's configuration at any time. Click the **Update Control Card** button at the bottom of the page to do so. Changes are immediately written to the control card and affect the router's switching matrix.

Note

Every control card in a router must be configured separately, but identically.

How to Configure Output Attributes

- 1 Go to the 'Output Attributes' page. From the **Video Routers** table at the bottom of the page, select a control card.

The attributes table controls the type of switch point, but not the actual moment in time of the switch, relative to the reference signal. Diagnostic equipment or specialized software is required for that.

- 2 If your router's audio signals are locked to an external AES reference, check the 'Require External AES Reference' check box.

- 3 In the 'Dual Video Reference Option' region, select **Redundant** or **Dual**:

Redundant—Both VIDEO REF 1 and VIDEO REF 2 ports on the router are used and identical. If one fails, the other is used as a fail-over. Choose a video rate that applies to both.

Or

Dual—The reference signals can be different. Choose a video rate for each reference port.

(The choices for video rates are 1080i, 720p, or 1080p. See [External References and Switch Point Configurations](#) on page 136.)

- 4 (Optional) Use the **Output Range** filter to limit the outputs that display:

Enter a start and end output number in the fields provided and click **Read Outputs**. Only the outputs in the range you entered are displayed.

Or

Click **Read All** to have the page display all outputs.

5 Define attributes for individual outputs:

Column	Options	Description
Re-clock / Bypass	Use Re-clocker Bypass Re-clocker	Choose to re-clock the signal or to bypass the re-clocker, retaining the signal's current rate. This option is available for standard outputs. Hybrid re-clockers cannot be bypassed. (The drop-down menu is disabled for hybrid outputs.) This column affects only Super Wide Band crosspoints.
HD / SD	Switch on SD Line Switch on HD Line	Choose Switch on SD Line if the output is SD (or analog video). Choose Switch on HD Line if the output is HD.

Alternatively, use the context menu to define these parameters for any or all outputs.

6 After you have made the changes you wanted to make, click **Update Control Card**, at the bottom of the page, to send your changes to the control card:



7 Each control card in the router must be configured separately and identically.

Either repeat this procedure for each control card in the router . . .

Or, finish making all changes to the control card and then copy its configuration to the remaining control card(s) in the router. See [Copy Settings Page](#) on page 69.

Miscellaneous Page

The 'Miscellaneous' page manages communication settings for the routers in your system:

Miscellaneous Settings

Router Serial Settings

Control Ports 1 and 2 Baud Rate Setting
Baud Rate: 38400

Control Port 1 Settings (RS422 / RS489)
Protocol: NV SERIAL
Control 1 (Main) Port: enabled
Reply When: active only

Control Port 2 Settings (RS422 / RS489)
Protocol: NV SERIAL
Control 2 (Aux) Port: disabled
Reply When: active only

Rear Diagnostic Port Settings (RS232)
Port Type: RS232
Baud Rate: 38400

Control Card Settings

Expansion Settings
 Stand Alone
 Expanded - Main
 Expanded - Expansion

Local Physical
Start End
Inputs: 1 128
Outputs: 1 256

Control Card Bus Type
 Internal
 10BASE2 Index:

Control Card's Date / Time
 Use this computer's date / time
Date (YYYY-MM-DD): 2014-01-17
Time (HH:MM[:SS]): 11:55

Ethernet Protocol Settings

ROT-16 Protocol
Primary Station IP Address: 192 . 168 . 102 . 73
Secondary Station ID: 128

Network Frame Summary

Control Cards Network Levels

Edit	Online	Name	Type	IP Address	Expansion
<input type="radio"/>	<input checked="" type="radio"/> Active	Kevin G's 8140	NV8140	192.168.102.107	Stand Alone
<input type="radio"/>	<input checked="" type="radio"/> Active	Unicon3 MRK 133	NV8576 Plus	192.168.102.133	Expanded - Main
<input type="radio"/>	<input checked="" type="radio"/> Active	NV8256+	NV8256 Plus	192.168.102.138	Stand Alone
<input type="radio"/>	<input checked="" type="radio"/> Standby	Unicon3 MRK 143	NV8576 Plus	192.168.102.143	Expanded - Main
<input type="radio"/>	<input checked="" type="radio"/> Active	Kevin's 8280	NV8280	192.168.102.151	Stand Alone
<input type="radio"/>	<input checked="" type="radio"/> Active	TS SQA NV8144	NV8144	192.168.102.210	Stand Alone
<input type="radio"/>	<input checked="" type="radio"/> Active	LH 8140	NV8140	192.168.102.212	Stand Alone
<input type="radio"/>	<input checked="" type="radio"/> Active	QA_NV8576+	NV8576 Plus	192.168.102.215	Expanded - Main
<input type="radio"/>	<input checked="" type="radio"/> Standby	QA_NV8576+	NV8576 Plus	192.168.102.216	Expanded - Main

Refresh Summary Update Control Card

NVISION series routers typically use Ethernet connections to communicate with the NV9000 router control system and with MRC. Some third-party router control systems use serial connections and require that serial ports be configured within MRC.

Using this page, you can set the serial communication parameters for your router(s).

Some routers (such as the NV8256-Plus and the expanded NV8576-Plus) have two router frames operating together. If you are configuring such a router, you can specify whether you are configuring the *main* or the *expansion* frame, or whether the frame is a *standalone* router.

The main frame is the one that is connected to the router control system. The expansion does not communicate with the router control system, but receives commands from main frame.

A single NV8576-Plus frame can operate as stand-alone router.

For other routers, these issues do not exist and the corresponding portions of the 'Miscellaneous Settings' page are greyed out.

Certain NV8500 routers support Sony's ROT-16 protocol. If your router does, the ROT-16 fields in the 'Ethernet Protocol Settings' section will be enabled.

Serial Port Settings

Two serial ports on the rear of the router frame, labeled CTRL 1 and CTRL 2, are available for router control system serial communication.

You can also configure the diagnostic ports (labeled DIAG) on the router frame.

(MRC does not communicate through serial ports.)

A third-party router control system requires a specific protocol. The NVISION router you are configuring will have the appropriate protocol installed on its control card(s).

The control card supports dual, simultaneous control so that it is possible to connect, for example, a third-party router control system to CTRL 1 and an NV9000 router control system (or other devices capable of running NVISION serial protocol) to CTRL 2.

Setting up serial communication does *not* disable Ethernet communication.

Viewing Serial Port Settings

The 'Miscellaneous Settings' page has 3 regions: 'Router Serial Settings' and 'Control Card Settings', and 'Ethernet Protocol Settings'. This illustration shows the settings for an NV8280:

For an NV8280, as illustrated here, there are no expansion options, so most of the control card settings are greyed out.

For certain routers, some options do not apply and those will be disabled (greyed out). For instance, the NV8500 series routers do not support the rear diagnostic port and that section of the page will be disabled.

Router Serial Settings

The 'Router Serial Settings' region provides the following information and options:

- Control 1 and 2 Baud Rate Setting

In this section, specify the Baud rate for both CTRL 1 and CTRL 2. The drop-down menu lists the acceptable Baud rates. The default is 38400 Baud.

- Control 1 Settings

These settings affect the CTRL 1 serial port.

In the protocol field, you can choose the protocol with which the router communicates with the control system.

In the second field, you can enable or disable this port. If the port is disabled, the other two fields in this section are ignored.

In the 'Reply When' field, choose one of two values:

- Active only — Reply to control system commands and queries only when the control card is the active card.
- Always — Always reply.

- Control 2 Settings

These settings affect the CTRL 2 serial port.

The protocol is always 'NV Serial'.

In the second field, you can enable or disable this port. If the port is disabled, the other field in this section are ignored.

In the 'Reply When' field, choose one of two values:

- Active only — Reply to control system commands and queries only when the control card is the active card.
- Always — Always reply.

- Rear Diagnostic Port Settings

These settings affect the DIAG serial port.

In the 'Port Type' field, choose either RS485 or RS232.

In the Baud Rate field, choose a suitable Baud rate.

(For NV8500 routers, these options are disabled.)

Control Card Settings

The 'Control Card Settings' region applies only to certain routers. These are the sections of the region:

- Expansion Settings

This section becomes enabled if you are configuring an expanded or expandable router (such as the NV8256-Plus or an NV8576-Plus)

Choose one of the options:

- 'Stand Alone' — the router has a single frame.
- 'Expanded - Main' — the router has two frames and this one is the main frame.
- 'Expanded - Expansion' — the router has two frames and this one is the expansion frame.

- Local Physical

If this section is enabled, enter the starting and ending numbers for the inputs and outputs of the frame you are configuring. This is a sample for the NV8256-Plus:

	Start	End
Inputs:	1	512
Outputs:	1	256

(For the NV8576-Plus, this section is disabled.)

- Control Card Bus Type

When more than one control card is installed in a router, the control cards communicate using an internal bus.

For certain routers, when the router frame is connected to another frame, communication between the control cards on the two frames occurs through the 10Base2 connections on the rear of the router frame. If that is the case for your router, this section will be enabled and you can choose '10BASE2': This is a sample for the NV8256-Plus:

Control Card Bus Type

Internal

10BASE2 Index: 1

In the 'Index' field, enter a number that serves as a frame "ID." Each frame of a multi-frame router must have a unique ID.

- Control Card Date Time

If the control card allows it, you can set the control card's date and time values.

Check the 'Use this computer's date / time' option if you want to use the date and time value in your computer. When you click 'Update Control Card' — as you must do for any of your settings to take effect — your computer's values are sent to the control card. Thereafter the check box becomes unchecked again.

Ethernet Protocol Settings

The 'Ethernet Protocol Settings' section has one section and that section is enabled if you are configuring an NV8500 router that supports Sony's ROT-16 protocol.

You must (1) check the 'ROT-16 Protocol' check box and (2) specify two parameters for the protocol if you wish to use the protocol.

These are the two parameters that apply:

- 'Primary Station IP Address'

This is the IP address of the (Sony ROT-16) server with which the router will communicate.

- Secondary Station ID

This is an ID for the router. The ID is used by the server.

Refer to the Sony ROT-16 literature for further information.

Configuring Serial Ports

If your router is connected to a third-party router control system that requires serial ports, you must configure the router's serial ports.

How to Configure Serial Ports

- 1 Go to the 'Miscellaneous Settings' page. From the **Control Cards** table at the bottom of the page, select a control card.
- 2 In the 'Control 1 and 2 Baud Rate Setting' section, select a baud rate from the 'Baud Rate' drop-down list.

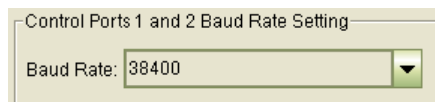

- 3 In the 'Control 1 Settings' and the 'Control 2 Settings' sections, set serial port parameters.
In the 'Protocol' field, select either **NV SERIAL** or another installed protocol from the drop-down list. (The only protocol available for CTRL 2 is NV Serial.)
Enable or disable the port.
In the 'Reply When' field, select how the control card responds to queries and commands:
 - **Active only**—the control card replies only when it is the active control card.
 - **Always**—the control card replies even when it is not the active control card.
- 4 (Optional) In the 'Rear Diagnostic Port Settings' section, select a port type (RS-485 or RS-232) and a Baud rate from the drop-down menus.
- 5 Click **Update Control Card**, at the bottom of the page, to write changes to the control card, overwriting any previous settings:



- 6 Each control card in the router must be configured separately and identically.
Either repeat this procedure for each control card in the router . . .
Or, finish making all changes to the control card and then copy its configuration to the remaining control card(s) in the router. See [Copy Settings Page](#) on page 69.

Expansion Settings

Certain routers comprise more than one frame. The NV8256-Plus and the NV8576-Plus are examples.

Two NV8576-Plus frames can be connected to form an "expanded NV8576-Plus" router. A single NV8576-Plus frame can also operate as a stand-alone router.

When two router frames are connected, one frame is designated as the *main frame* and one frame as the *expansion frame*. The main frame is the one that is connected to the router control system. The expansion frame does not communicate with the router control system, but receives commands from main frame.

Any changes made to the main frame's crosspoints are automatically sent to the expansion frame ensuring synchronization between the connected frames. Expansion frame configurations should not be updated independently of the main frame.

Each control card on each of the router frames must be configured separately and identically. For routers with two frames, be sure to set all control cards on one frame as *main* and all control cards on the remaining frame as *expansion*.

How to Set a Frame as Main or Expansion

1 Go to the 'Miscellaneous Settings' page. From the **Control Cards** table at the bottom of the page, select a control card (for a router that has two frames).

2 In the 'Expansion Settings' section, click a radio button for the frame you are configuring:

- **Expanded - Main** — Designates the frame, for the control card you are modifying, as the main frame.

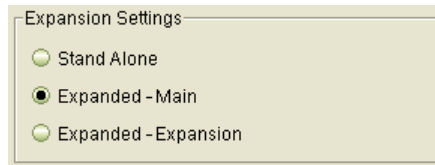

- **Expanded - Expansion** — Designates the frame, for the control card you are modifying, as the expansion frame.

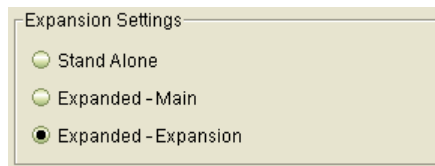

3 The following settings are optional and do not apply to NV8500 routers:

- a In the 'Local Physical' section, enter a start and end number for the router's inputs and outputs *in this frame*. This is an example for the NV8256-Plus:

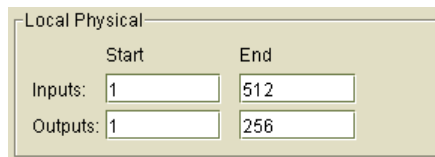

- b In the Control Card Bus section, if your router requires it, select the **10BASE2** radio button. The frames of older two-frame routers, such as the NV8256-Plus, communicate through their 10base2 connections. Choosing **10BASE2** is appropriate for these routers.

In the 'Index' field, enter a number that serves as a frame "ID." Each frame of a multi-frame router must have a unique ID.

4 Click **Update Control Card**, at the bottom of the page, to write changes to the control card, overwriting any previous settings.

5 Each control card in the router must be configured separately and identically.

Either repeat this procedure for each control card in the router . . .

Or, finish making all changes to the control card and then copy its configuration to the remaining control card(s) in the router. See [Copy Settings Page](#) on page 69.

Module Types

The 'Module Types' page is for NV8500 hybrid routers only. This is evidenced by the 'Hybrid Routers' table at the bottom of the page. The table lists only hybrid routers and you can select only control cards for hybrid routers in this table:

Module Type Settings

Location	Present	Module
Upper Input 01	No	
Upper Input 02	No	
Upper Input 03	No	
Upper Input 04	Yes	NV8500 3Gig SDI DEM 8 COAX IN (EM0814)
Upper Input 05	Yes	NV8500 3Gig SDI DEM 8 COAX IN (EM0814)
Upper Input 06	Yes	NV8500 3Gig SDI DEM 8 COAX IN (EM0814)
Upper Input 07	No	
Upper Input 08	Yes	NV8500 3Gig SDI DEM 8 COAX IN (EM0814)
Upper Input 09	No	
Upper Input 10	Yes	NV8500 3Gig SDI DEM 8 COAX IN (EM0814)
Upper Input 11	No	
Upper Input 12	Yes	NV8500 3Gig SDI DEM 8 COAX IN (EM0814)
Upper Input 13	No	
Upper Input 14	Yes	NV8500 3Gig COAX 8 SDI / 1 TDM IN (EM0814)
Upper Input 15	No	
Upper Input 16	No	
Upper Input 17	No	
Upper Input 18	Yes	NV8500 3Gig SDI DEM 8 COAX IN (EM0814)
Upper Input 19	No	
Upper Input 20	No	

Key

- Expected Module in Expected Location
- Pending / Non-reporting Module in Location
- Unexpected Module Change in Location

Display: All Locations

Router Front Router Back

Network Frame Summary

Hybrid Routers Network Levels All Control Cards

Edit	Online	Name	Type	IP Address	Expansion
<input type="radio"/>	Active	Unicon3 MRK 133	NV8576 Plus	192.168.102.133	Expanded - Main
<input type="radio"/>	Standby	Unicon3 MRK 143	NV8576 Plus	192.168.102.143	Expanded - Main
<input type="radio"/>	Active	NV8576	NV8576	192.168.102.152	Stand Alone
<input type="radio"/>	Active	Kevin's 8280	NV8280	192.168.102.155	Stand Alone
<input type="radio"/>	Active	Jowel's NV8140	NV8140	192.168.102.167	Stand Alone
<input checked="" type="radio"/>	Active	QA_8576+	NV8576	192.168.102.210	Stand Alone

Refresh Summary Update Control Card View Change Report...

The 'Module Types' page specifies the card types that are installed in the slots of the router or are to be installed in the router at some future date. That you can specify a module type for a card that is to be installed helps to ensure that the correct modules are installed in the slots.

The table includes data for all input, output, monitor, control, crosspoint, and power supply modules. The page displays a picture of the router to the right of the table. When you select a module, MRC highlights the card location in the picture in yellow. There are two "radio buttons" under the picture of the router that allow you to view the router from the front or the rear. You can scroll the router picture to view the card you selected.

Power supplies for the NV8280, NV8576, and NV8576-Plus are external and are not displayed in the graphic.

Initially, the 'Module Types' page creates a list of all modules in your router frame. This is the 'Module Type Settings' table. This table has a row for every configurable slot in the router frame. However, the table also has a filter so that you can restrict the display to slots of a certain type. Choose one of the entries in the 'Display' drop-down menu to apply the filter:

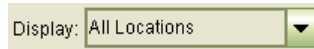

If you are configuring an expanded NV8576-Plus, which has two frames, the table can show the slots for both the main and expansion frames of the router. In this case, the page has an additional drop-down menu in which to choose whether to display slots for the main frame or the expansion frame, or both:



Each table row has 3 fields, with the following meaning:

- 'Location'
The text in this field identifies the slot in the router.
The text in this field is coded to be compact. See [Nomenclature](#) on page 50.
- 'Present'
A 'Yes' or 'No' in the check box of this field indicates that a card is present in the slot.
- 'Module'
The text in this field gives the card type in the slot. If the field is blank, there is no card in the slot.
The text in this field is coded to be compact. See [Nomenclature](#) on page 50.

The color of the text in table of the table gives you information about the slots. The page shows a key, at the top right, to these color codes in case you forget:

- Red text — the table entry shows an unexpected module change.
Either a card of a different type has been inserted in the slot or the card has been removed from the slot.
For cards that have been removed, the 'Module' field can be modified — the field has a drop-down menu.
The key at the top of the page reads: 'Unexpected Module Change in Location.'
- Black text — the table entry matches what is in the slot.
Bold black text means that the slot has an actual card of the indicated type. Fields with bold black text cannot be modified.
The key at the top of the page reads: 'Expected Module in Expected Location.'
Plain black text means that the table entry has a *proposed* or *pending* card type and that there is no card in the slot. The 'Module' field can still be modified.
As mentioned, if the 'Module' field is empty, there is no card in the slot.
The key at the top of the page reads: 'Pending or Non-Reporting Module in Location.'

Selecting Slots

Selected rows (slots) are a darker green. Unselected rows are either white or light green.

You can use click, shift-click, and control-click techniques to select any or all rows in the table. You can also use the context menu of the module table to perform selections.

You can also click any module in the drawing to select it. When you do so, the module is highlighted in yellow in the drawing and the module is highlighted in the module list.

Clicking a module in the drawing causes any previously selected modules to become unselected.

Context Menus

There are two context menus that are important for this page, one for the 'Hybrid Routers' table, and another for the module type table.

Hybrid Routers Table

The global context menu appears when you right-click a row in the 'Hybrid Routers' table at the bottom of the page:



See [Context Menu](#) on page 23 for information.

Module Type Table

This context menu appears when you right-click a row in the module type table at the top of the page:

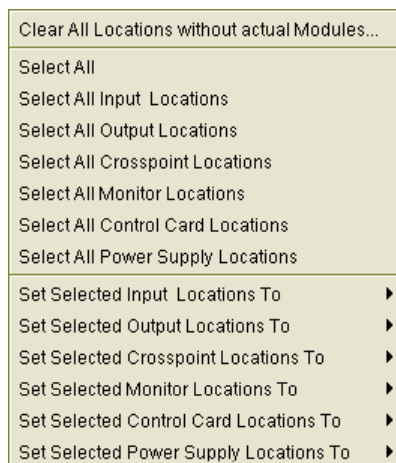

This context menu can help speed up the process of assigning module types. Many of the commands in the context menu are bulk selection commands. Other commands in the menu let you set the type of all selected cards. (See [Assigning Module Types](#) on page 67.)

These are the selection commands:

- **Clear all locations without actual modules** — clear all rows for which the corresponding slot has no module installed. (The 'Module' fields of these rows become blank and the text of the row turns black if it was red.)
- **Select All** — select all modules including the power supply modules.
- **Select All Inputs Locations** — select all (and only) input modules.
- **Select All Outputs Locations** — select all (and only) output modules
- **Select All Crosspoint Locations** — select all (and only) crosspoint modules.
- **Select All Monitor Locations** — select all (and only) monitor modules.
- **Select All Control Card Locations** — select all (and only) control cards.
- **Select All Power Supply Locations** — select all (and only) power supply modules.

Setting the Card Type

The context menu has several commands that allow you to apply a card type to selected slots:

- Set selected input locations to . . .
- Set selected output locations to . . .
- Set selected crosspoint locations to . . .
- Set selected monitor locations to . . .
- Set selected control card locations to . . .
- Set selected power supply locations to . . .

Clicking any of these commands causes a submenu of card types appropriate for the card class to appear. Choose any card type. The selected slots acquire that card type.

It is not possible to perform an incorrect card assignment using these commands. However, if the card type you select does not match the physical card, the mismatch will be flagged.

(Your modification does not become effective until you click **Update Control Card** at the bottom of the page.)

Resetting Card Types after a Firmware Update

After you perform a firmware update of an NV8500 series router control card, select the control card in the 'Hybrid Routers' tab of the 'Module Types' page, then click **Update Control Card** in the 'Module Types' page. MRC will repopulate the module list.

Using the Module Types Page

The 'Module Types' page provides a table of all the router's module slot and what type of module is configured for that slot.

Viewing a Subset of the Modules

To view modules, select an option from the 'Display' drop-down menu below the table and (if the router is an expanded NV8576-Plus), the main/expansion drop-down menu:



- **All Locations**— show all modules installed in the frame. This is the default.
- **Input Locations Only**— show only input modules
- **Non I/O Locations Only**— show all control cards, monitor modules, crosspoint modules, and power supply modules. No input or output modules are listed.
- **Output Location Only**— show only output modules.

If the router is an expanded NV8576-Plus, the main/expansion drop-down menu has 3 entries:

- **Main and Expansion Frame**— show slots of both the main frame and the expansion frame.
- **Main Frame**— show only slots of the main frame.
- **Expansion Frame**— show only slots of the expansion frame.

Assigning Module Types

In the module table, the 'Module' field for slots that have a card installed appears in bold black text. All other slots are (physically) empty, and the rows for those slots have a drop-down menu in the 'Module' field. For those rows, the 'Module' field might have text (red if the entry is invalid, black if the entry is valid, but a *proposed* or *pending* card type).

You can assign a card type to any slot for which the row has a drop-down menu.

The simplest way to assign a card type to an empty slot is to click in the 'Module' field (which has a drop-down menu) and select a module type from the drop-down menu. (See [Nomenclature](#) on page 50.)

Only those modules that can be installed in that slot are listed.

Troubleshooting Module Type Errors

If a slot is configured to receive a specific card type, and someone installs a different card type or removes the installed card, an alarm is triggered. Within MRC, alarm signals are distributed to three separate pages: 'Module Types', 'Module Status', and 'System Status'.

In the 'Module Types' page, a red dot appears on the 'View Change Report' button when the router's control card reports an unexpected module change. Click **View Change Report**, at the bottom of the page, to view the error message(s) at any time.



This is a sample of the report:

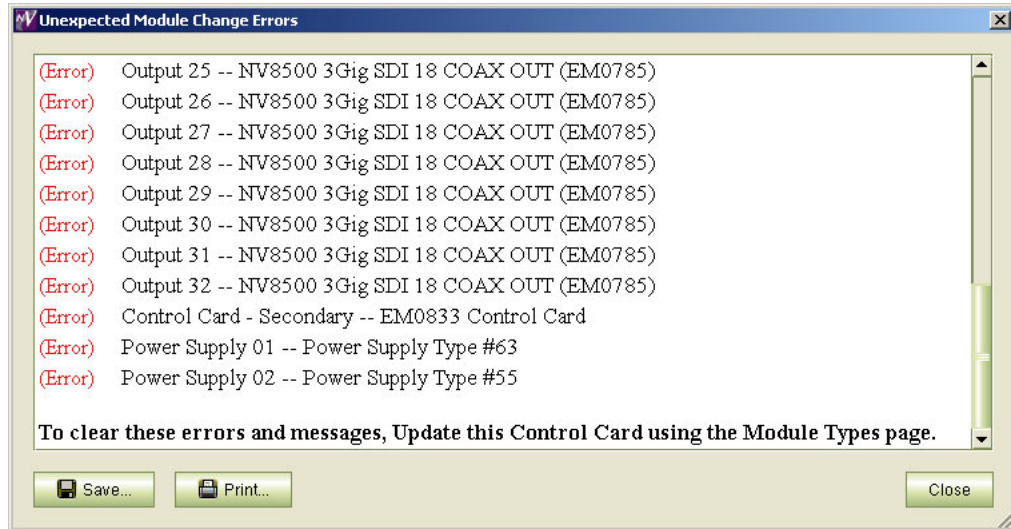

Alarms are also sent through SNMP to the router control system and router alarm ports, which might be connected to an external alarming circuit.

You can correct an error by:

- Changing the card type assigned to the slot so that it matches the card physically installed in the slot.
- Removing the installed card and replacing it with a card that matches the card type assigned to that slot.

How to Change Individual Modules

- 1 Go to the 'Module Types' page. From the **Hybrid Routers** table at the bottom of the page, select a control card.

If module error(s) has been detected for this router, the 'Unexpected Module Change Errors' window appears. (You can click **Print** to print the error list for reference or click **Save** to save it to a file.)

- 2 Scroll to the row for the slot you are modifying. (Only rows for which the 'Module' field has a drop-down menu can be modified. That is, you can modify the card type only for empty slots.)
- 3 Click the 'Module Type' field and select a card type from the drop-down menu that appears.
- 4 Repeat steps 1–3 for other slots you want to modify.
- 5 Click **Update Control Card**, at the bottom of the page, to write changes to the control card:



- 6 Each control card in the router must be configured separately and identically.

Either repeat this procedure for each control card in the router . . .

Or, finish making all changes to the control card and then copy its configuration to the remaining control card(s) in the router. See [Copy Settings Page](#) on page 69.

How to Change the Type for a Group of Modules

This procedure assigns the same card type to all cards of a card class (input, output, etc.)

- 1 Go to the 'Module Types' page. From the **Hybrid Routers** table at the bottom of the page, select a control card.
If module error(s) has been detected for this router, the 'Unexpected Module Change Errors' window appears. (You can click **Print** to print the error list for reference or click **Save** to save it to a file.)
- 2 Select any or all slots you want to modify. You can do this manually or use the module table's context menu. You can perform additional selections or deselections after using the context menu.
- 3 In the context menu, select one of the commands (such as 'Set Selected Input Locations to') and choose a card type from the submenu that appears:

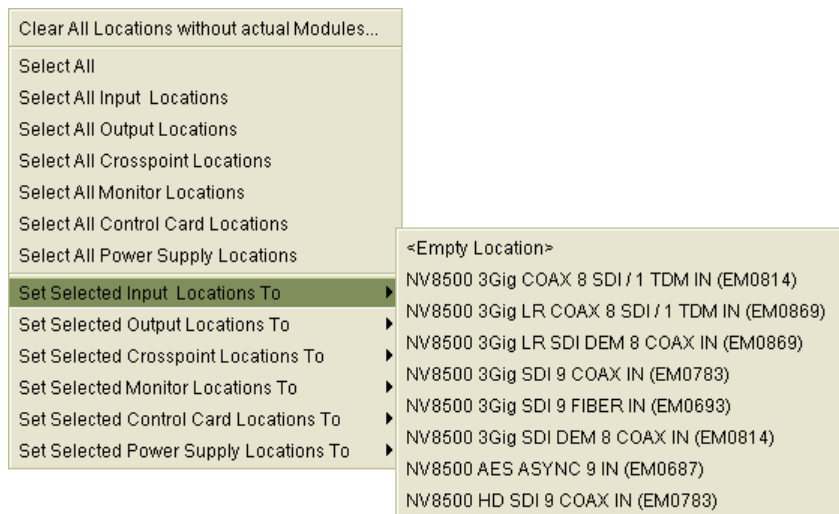

- 4 Repeat step 3 for other card classes (such as output).
- 5 Click **Update Control Card**, at the bottom of the page, to write changes to the control card:



- 6 Each control card in the router must be configured separately and identically.
Either repeat this procedure for each control card in the router . . .
Or, finish making all changes to the control card and then copy its configuration to the remaining control card(s) in the router. See [Copy Settings Page](#) on page 69.

Copy Settings Page

The 'Copy Settings' page allows you to copy control card data.

The upper portion of the page contains a table of control cards. This is the 'From Device' table. When you copy, it is from the control card you select in this table.

The lower portion of the page contains the 'Copy To' table and this is where you select the target of the copy. You can copy control card configuration to 3 kinds of targets:

- Another control card, in the same router or in another router (of the same type).

- To a virtual control card. A “virtual” control card does not correspond to an actual router. It can be used for whatever purpose you find. A virtual control card might, for example, contain a “master” configuration that you can copy to real control cards.
- An external file. Exporting a configuration to a file is a way to distribute the configuration or to archive the configuration. Exporting a configuration is a necessity if you encounter problems configuring your router. If you report a problem, Miranda technical support will want a copy of your configuration for diagnostic purposes. (Exported files are .zip files.)

The page has an ‘Import Configuration’ button with which you can import saved configurations.

The middle portion of the page contains a set of check boxes in which you can enable or disable parts of the configuration for copying.

The screenshot shows the 'Copy Settings' page with the following sections:

From Device

Select	Online	Name	Type	IP Address	Expansion
<input type="radio"/>	<input checked="" type="checkbox"/>	NV8256+	NV8256 Plus	192.168.102.138	Stand Alone
<input checked="" type="radio"/>	<input checked="" type="checkbox"/>	Stuarts + Main	NV8576 Plus	192.168.102.190	Expanded - Main
<input type="radio"/>	<input checked="" type="checkbox"/>	Stuarts + Exp	NV8576 Plus	192.168.102.191	Expanded - Expansion
<input type="radio"/>	<input checked="" type="checkbox"/>	QA_8144	NV8144	192.168.102.212	Stand Alone
<input type="radio"/>	<input checked="" type="checkbox"/>	QA_8144	NV8144	192.168.102.213	Stand Alone
<input type="radio"/>	<input checked="" type="checkbox"/>	NV5128	NV5128	192.168.102.225	Stand Alone
<input type="radio"/>	<input checked="" type="checkbox"/>	NV5128	NV5128	192.168.102.248	Stand Alone
<input type="radio"/>	<input checked="" type="checkbox"/>	NV5128	NV5128	192.168.102.249	Stand Alone

Settings To Be Copied

Configuration Data	Read Only Status Data
<ul style="list-style-type: none"> Network Settings <ul style="list-style-type: none"> <input type="checkbox"/> IP Address and Subnet Mask <input checked="" type="checkbox"/> Network Gateway Address <input checked="" type="checkbox"/> Device Name <input checked="" type="checkbox"/> Configuration Lock Configuration Settings <ul style="list-style-type: none"> <input checked="" type="checkbox"/> Router Levels <input checked="" type="checkbox"/> Input Port Settings <input checked="" type="checkbox"/> AES Reference Setting <input checked="" type="checkbox"/> Dual Reference Setting <input checked="" type="checkbox"/> Switch Point Settings 	<ul style="list-style-type: none"> <input checked="" type="checkbox"/> Control Card State <input checked="" type="checkbox"/> System Status <input checked="" type="checkbox"/> Version Data <input checked="" type="checkbox"/> RF File Version Data <input checked="" type="checkbox"/> Available Protocols <input checked="" type="checkbox"/> Status of Modules <input checked="" type="checkbox"/> Serial EE Chip Status <input checked="" type="checkbox"/> Control Card Running Log <input checked="" type="checkbox"/> Control Card Startup Log

Copy To

Select	Online	Name	Type	IP Address	Expansion
<input type="radio"/>	<input checked="" type="checkbox"/>	Stuarts + Exp	NV8576 Plus	192.168.102.191	Expanded - Expansion
<input type="radio"/>	<input checked="" type="checkbox"/>	Create Configuration			
<input type="radio"/>	<input checked="" type="checkbox"/>	Export To File			
<input type="radio"/>	<input type="checkbox"/>				
<input type="radio"/>	<input type="checkbox"/>				

Buttons: Refresh Summary, Copy Settings..., Import Configuration...

Copying settings to all the control cards in a router frame ensures that the control cards have identical configurations. This is important! Errors will occur if a router’s control cards have differing configurations.

You can safely copy a main frame's configuration to the control card of the expansion frame. Making configuration settings on a virtual control card lets you make changes to a configuration without adversely affecting a router. (Updating the control cards in a router that is in service can be a complex procedure.)

How to Copy Control Card Settings

1 Go to the 'Copy Settings' page. In the 'From Device' table, select a control card. MRC will copy configuration data from this control card.

2 In the 'Copy To' section, select a "target" to which the configuration and status data will be copied.

You can copy to a virtual control card, or to a file, or to another control card. The other control card must be of the same type. For example, you cannot copy an NV8144 configuration to an NV8280.

Note: if you are exporting a configuration, the 'Settings to Be Copied' region is blank.

3 If the 'Settings to Be Copied' region is not blank, select the data types to be copied. You can click 'Check All' or 'Uncheck All' as a shortcut:



This is the 'Settings to Be Copied' section:

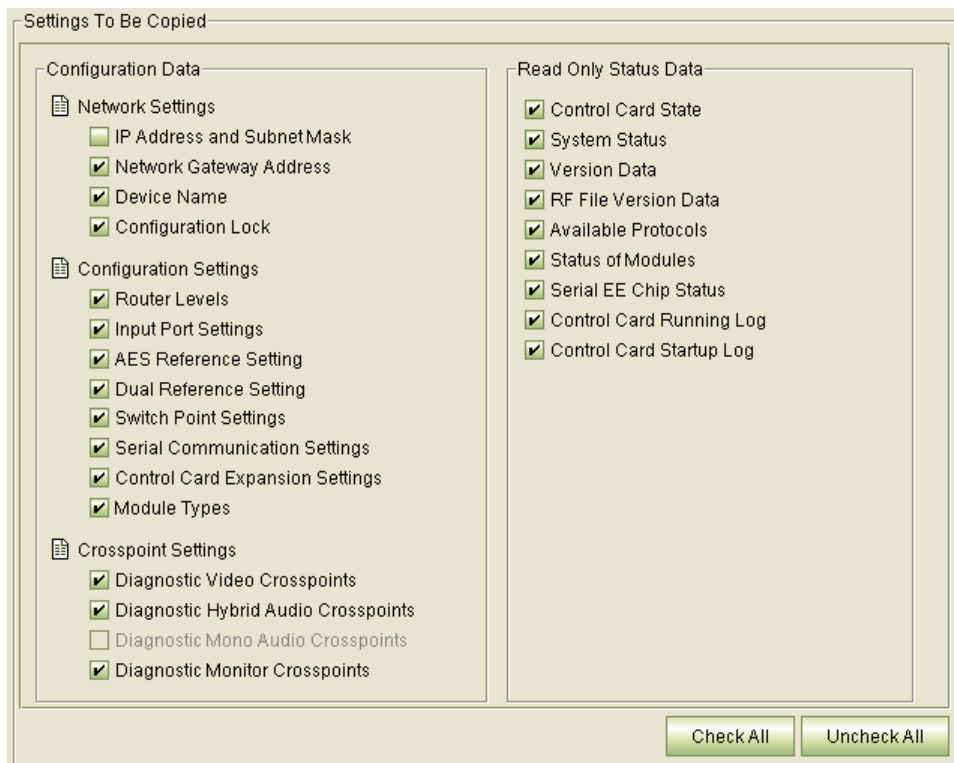

MRC disables any option that does not make sense for the copy. For instance, if you are copy a control card configuration to another control card, it disables the 'IP address and subnet mask' option.

If you are copying a main frame configuration to an expansion control card, it disables the crosspoint options.

This is what the 'Network Settings' check boxes mean:

Setting	Description	Related Topic
IP Address and Subnet Mask	IP address currently assigned to the control card Note: by default, this option is unchecked. Control cards on a network must not have identical IP addresses.	The MRC Network on page 129 Ethernet Settings Page on page 119
Network Gateway Address	A gateway is a network router that allows two subnets to communicate. A gateway IP address identifies the gateway, allowing a device to communicate with the other subnet.	
Device Name	The name assigned to the router frame in which the control card is installed.	—
Configuration Lock	Whether the control card configuration is locked.	Locking and Unlocking Configurations on page 126

This is what the 'Configuration Settings' check boxes mean:

Setting	Description	Related Topic
Router Levels	Organizational partitions for different signal types	Levels on page 134 Router Levels Page on page 37
AES Reference Setting	Whether an AES reference is required.	Output Attributes Page on page 50
Dual Reference Setting	Specifies whether the router has redundant or dual reference inputs and their video rates.	Redundant and Dual Video References on page 139 Output Attributes Page on page 50
Output Attributes	Whether signals reclock or bypass the reclocker and whether the output ports are HD or SD .	Output Attributes Page on page 50
Serial Communications Settings	The serial port parameters for the router's CTRL1, CTRL2, and DIAG ports.	Miscellaneous Page on page 57
Control Card Expansion Settings	For expanded routers, whether the control card is in the main frame or the expansion frame.	Miscellaneous Page on page 57
Module Types	A table that enumerates the card types in the slots of the router (for NV8500 hybrid routers only).	Module Types on page 63

This is what the 'Crosspoint Settings' check boxes mean:

Setting	Description	Related Topic
Diagnostic Video Crosspoints	The entire video crosspoint state without regard to partitioning (for routers that switch video).	—
Diagnostic Hybrid Audio Crosspoints	The entire hybrid audio crosspoint state without regard to partitioning (for hybrid routers only).	—
Diagnostic Mono Audio Crosspoints	The entire mono audio crosspoint state without regard to partitioning (for routers that switch mono audio).	—
Diagnostic Monitor Crosspoints	The entire monitor crosspoint state without regard to partitioning (for routers that have monitor levels).	—

This is what the 'Read Only Status Data' check boxes mean:

Setting	Description	Related Topic
Control Card State	The current state of the control card (e.g., online, offline, active, stand-by, virtual, healthy, unhealthy).	Control Card State Indicators on page 16
System Status	The overall router status.	System Status on page 107
Version Data	The version numbers of the firmware running on the control card.	Firmware Page on page 28
RF File Version Data	The version number of the .RF file stored on the control card.	Firmware Page on page 28
Available Protocols	The native and third-party protocols currently available on the control card.	Firmware Page on page 28
Status of Modules	Status for all input, output, monitor, crosspoint, control, and power supply modules.	Module Status Page on page 109
Serial EE Chip Status	Status of the non-volatile memory (EEPROM) on the control card.	—
Control Card Running Log	The control card's running event log.	Logs Page on page 106
Control Card Startup Log	The control card's startup event log.	Logs Page on page 106

Important: do *not* copy these data unless you are exporting a configuration or creating a virtual configuration.

4 Click **Copy Settings**.

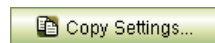

Then click **Yes** on the confirmation window.

If you are exporting to a file, a **Browse** dialog appears and you must designate a file in which to save the configuration data. A confirmation window will appear. Click **OK** in the confirmation window.

4 Router Tools

The pages in MRC's 'Router Tools' section allow you to perform router management tasks after configuration is complete. Using these pages, you can test crosspoint switching, create crosspoint salvos, view system logs, and view system and module statuses and alarms.

These are the 'Router Tools' pages:

- Crosspoints
- Logs
- System Status
- Module Status.

Each page handles a specific set of post-configuration tasks:

Task	Description	Related Topic
Test the crosspoint matrix	Switching a signal from an input to an output occurs in the crosspoint matrix. Using the 'Crosspoints' page, you can view, test, and update a router's video (and audio) routes.	Crosspoints Page on page 76
Create "snapshots" of the crosspoint	Salvos are "snapshots" of a crosspoint matrix. The salvo can be used to reset a crosspoint.	Using Salvos on page 101
View logs	The 'Logs' page displays the current running and startup logs of the selected control card. You can save logs for future reference.	Logs Page on page 106
View system status and alarms	The 'System Status' page provides a compact overview of the "health" of a router's control cards, modules, frame, power supplies, and fans. This page displays system alarms.	System Status on page 107
View the status of installed modules	The 'Module Status' page lists the cards installed in a router's slots and gives the "health" of the card.	Module Status Page on page 109

Topics

<i>Crosspoints Page</i>	76
<i>Using Salvos</i>	101
<i>Logs Page</i>	106
<i>System Status</i>	107
<i>Module Status Page</i>	109

Crosspoints Page

Routers switch input signals to selected outputs. The actual connection of an input to an output occurs in the router's crosspoint matrix. Every output — whether video, audio, or other — in a router can be viewed in the 'Crosspoints' page:

Crosspoints

Current History Incrementing Takes Single Takes

Destination	Source	Locked	Protected	LID	Status
1	1	<input type="checkbox"/>	<input type="checkbox"/>	0	
2	1	<input type="checkbox"/>	<input type="checkbox"/>	0	
3	1	<input type="checkbox"/>	<input type="checkbox"/>	0	
4	1	<input type="checkbox"/>	<input type="checkbox"/>	0	
5	1	<input type="checkbox"/>	<input type="checkbox"/>	0	
6	1	<input type="checkbox"/>	<input type="checkbox"/>	0	
7	1	<input type="checkbox"/>	<input type="checkbox"/>	0	
8	1	<input type="checkbox"/>	<input type="checkbox"/>	0	
9	1	<input type="checkbox"/>	<input type="checkbox"/>	0	
10	1	<input type="checkbox"/>	<input type="checkbox"/>	0	
11	1	<input type="checkbox"/>	<input type="checkbox"/>	0	
12	1	<input type="checkbox"/>	<input type="checkbox"/>	0	
13	1	<input type="checkbox"/>	<input type="checkbox"/>	0	
14	1	<input type="checkbox"/>	<input type="checkbox"/>	0	
15	1	<input type="checkbox"/>	<input type="checkbox"/>	0	
16	1	<input type="checkbox"/>	<input type="checkbox"/>	0	
17	1	<input type="checkbox"/>	<input type="checkbox"/>	0	
18	1	<input type="checkbox"/>	<input type="checkbox"/>	0	
19	1	<input type="checkbox"/>	<input type="checkbox"/>	0	
20	1	<input type="checkbox"/>	<input type="checkbox"/>	0	
21	1	<input type="checkbox"/>	<input type="checkbox"/>	0	
22	1	<input type="checkbox"/>	<input type="checkbox"/>	0	
23	1	<input type="checkbox"/>	<input type="checkbox"/>	0	
24	1	<input type="checkbox"/>	<input type="checkbox"/>	0	
25	1	<input type="checkbox"/>	<input type="checkbox"/>	0	

Output Filter: Min: Max: Clear

Level: Video Diagnostic

Tools:

Network Frame Summary

Control Cards Network Levels

Edit	Online	Name	Type	IP Address	Expansion
<input type="radio"/>	Active	Unicon3 MRK 133	NV8576	192.168.102.133	Stand Alone
<input type="radio"/>	Active	NV8256+	NV8256 Plus	192.168.102.138	Stand Alone
<input type="radio"/>	Standby	Unicon3 MRK 143	NV8576	192.168.102.143	Stand Alone
<input checked="" type="radio"/>	Active	Kevin's NV8280	NV8280	192.168.102.151	Stand Alone
<input type="radio"/>	Active	Jeremy's NV8280	NV8280	192.168.102.152	Stand Alone

Refresh Summary Open Salvo... Save As Salvo...

Using the 'Crosspoints' page, you can view, test, and update crosspoint connections. Making a crosspoint connection is called performing a *take*. Within a router, a take occurs when an input is switched to an output.

Note: in the 'Crosspoints' page, inputs are called *sources* and outputs are called *destinations*. Please do not confuse these terms with the sources and destinations of the NV9000 router control system.

The 'Crosspoints' page has two regions. The upper region is a work area. The lower region is the 'Network Frame Summary' which contains a 'Control Cards' table. Use the 'Control Cards' table to select a control card of the router for which you want to view or test crosspoints.

The upper region has 4 tabbed work areas:

- 'Current'

This work area is a table that displays the crosspoint matrix for the currently selected level. At the bottom of the table are fields where you can specify a filter to reduce the number of outputs displayed and a drop-down menu where you can select the level to display. The levels you can select depend on the router. However, MRC also provides one or more diagnostic levels in addition. Again, these depend on the router.

The 'Current' crosspoint table is "live" — changes made in the table are immediately sent to the router. Changes made in the router's crosspoint immediately become visible in the 'Current' table.

- 'History'

This work area is a record of your actions using the 'Crosspoints' page. Using this tab, you can revert the crosspoint to a previous state, as you would use an "undo" feature.

(See [History Tab](#) on page 94.)

- 'Incrementing Takes'

This work area lets you perform a series of takes on a range of destinations and sources in an incrementing or decrementing sequence. This is especially helpful for performing tests.

(See [Incrementing Takes Tab](#) on page 92.)

- 'Single Takes'

This work area lets you perform either single takes or "chop" takes.

(See [Single Takes Tab](#) on page 96.)

The creation of "salvos" can place additional tabs in the upper region. See [Using Salvos](#) on page 101.

Diagnostic Levels

The 'Crosspoints' page provides one or more diagnostic levels for your router in addition to the physical levels you have defined. The diagnostic levels encompass the entire crosspoint space of the router and are independent of the levels (or partitions) you have defined. They are useful for testing.

Context Menus













The 'Crosspoints' page has two context menus.

The "global" context menu applies to the 'Control Cards' table at the bottom of the page;



See [Context Menu](#) on page 23 for information.

The other is for use with the tables of the upper region.

 Copy	Ctrl-C
 Paste...	Ctrl-V
 Add New Output...	A
 Delete	Delete
 Create Salvo	
 Save As Salvo...	Ctrl-S
 Take...	
 Jump to Output...	
 Unlock All...	
 Range Take...	Ctrl-R
 Audio Range Take...	
 Diagonal Take...	Ctrl-D

“Live” Changes

Changes made in the ‘Current’ table result immediately in changes in the crosspoint matrix of the router. (Use caution in the ‘Current’ table for a router that is on air.)

(See [Routing](#) on page 131.)

Salvos

Using the ‘Crosspoints’ page, you can take a “snapshot” of a crosspoint matrix. MRC calls such snapshots *salvos*. A salvo can be saved as a separate file. If a system failure occurs, the salvo can be uploaded to reset the crosspoint matrix in the router.

For information on creating, updating, and deleting salvos, see [Using Salvos](#) on page 101.

Locks and Protects

In the NV9000 router control system, and perhaps other router control systems, sources and destinations can be (1) locked or (1) protected. The ‘Crosspoints’ page of MRC recognizes *destination* locks and protects, but does not recognize *source* locks and protects.

Destination Lock: no one, including the person who locked the destination, may route to the destination until the destination is released (unlocked).

Destination Protect: no one except the person who locked the destination may route to the destination until the destination is released (un-protected).

Locks and protects are applied in the router control system, usually at a control panel. Typically, a lock or protect is “owned” by the person who set it and can be removed only by the owner or an administrative user. The ‘Current’ table of the ‘Crosspoints’ page has a column labeled ‘LID’ — for “lock ID” — that gives an ID representing the “owner.”

At present, locks and protects can only be released globally. The ability to release individual locks and protects is planned for the future.

How to Release All Locks and Protects

- 1 Go to the 'Crosspoints' page. From the 'Control Card' tab at the bottom of the page, select a control card for the router of interest.
- 2 Either click the **Unlock** icon (accessible in the 'Current' tab):



or select **Unlock All . . .** from the context menu. All locks and protects are released.

Takes

An input can be routed to any or all outputs. An output, however, can take exactly one input.

In the following illustration, you can see that input 2 (called source 2) has been taken to almost all the outputs visible in the window. Input 7 has been taken to output 5 and input 11 has been taken to output 19.

(You perform a take by typing an input number in the 'Source' column for the output (destination) of interest. When you do, the Status column reads "Success" for that output.

The columns 'Locked' and 'Protected' have check boxes that show whether the outputs are locked or protected.

The 'LID' column shows an ID for the "owner" of the lock or protect. (The "owner" IDs are issued by the NV9000 system.)

Takes for Non-Existent Ports (for NV8500 Series Routers)

In general, MRC reports takes (and the status of the takes) for any non-existent port (video or audio) as if the ports exist.

Takes for Ports Belonging to Empty Slots

You will generally see "Invalid Src" or "Invalid Dst" for takes involving ports in empty slots. You might also see an "Out of Range" message.

(If you have configured a provisionally card type for an empty slot, you will not see such errors.)

Output embedders can be affected by inputs "taken" from empty slots.

Because an empty slot is considered a "standard" card slot, inputs from those slots are considered standard inputs. The embedders in outputs to which these inputs are routed are bypassed automatically (unless the input is set to force the embedder on).

Consequently, the table rows for such outputs show "embedder bypassed" in the 'Destination' column.

The following shows how video signals appear in the 'Current' table:

Destination	Source	Locked	Protected	LID	Status
1	2	<input type="checkbox"/>	<input type="checkbox"/>	0	
2	2	<input type="checkbox"/>	<input type="checkbox"/>	0	
3	2	<input checked="" type="checkbox"/>	<input type="checkbox"/>	1	
4	2	<input type="checkbox"/>	<input type="checkbox"/>	0	
5	7	<input type="checkbox"/>	<input type="checkbox"/>	0	Success
6	2	<input type="checkbox"/>	<input type="checkbox"/>	0	
7	2	<input type="checkbox"/>	<input type="checkbox"/>	0	
8	2	<input type="checkbox"/>	<input type="checkbox"/>	0	
9	2	<input type="checkbox"/>	<input type="checkbox"/>	0	
10	2	<input type="checkbox"/>	<input type="checkbox"/>	0	
11	2	<input type="checkbox"/>	<input type="checkbox"/>	0	
12	2	<input type="checkbox"/>	<input checked="" type="checkbox"/>	1	
13	2	<input type="checkbox"/>	<input type="checkbox"/>	0	
14	2	<input type="checkbox"/>	<input type="checkbox"/>	0	
15	2	<input type="checkbox"/>	<input type="checkbox"/>	0	
16	2	<input type="checkbox"/>	<input type="checkbox"/>	0	
17	2	<input type="checkbox"/>	<input type="checkbox"/>	0	
18	2	<input type="checkbox"/>	<input type="checkbox"/>	0	
19	11	<input type="checkbox"/>	<input type="checkbox"/>	0	Success
20	2	<input type="checkbox"/>	<input type="checkbox"/>	0	
21	2	<input type="checkbox"/>	<input type="checkbox"/>	0	
22	2	<input type="checkbox"/>	<input type="checkbox"/>	0	
23	2	<input type="checkbox"/>	<input type="checkbox"/>	0	
24	2	<input type="checkbox"/>	<input type="checkbox"/>	0	
25	2	<input type="checkbox"/>	<input type="checkbox"/>	0	

In the general case, audio crosspoints are treated the same way as video crosspoints. However, for the NV8500 hybrid routers, audio is more complex because it can be embedded in video signals and extracted and recombined at output and because the NV8500 hybrid routers can have MADI input and output cards. The hybrid disembedder (input) cards and hybrid embedder (output) cards support 16 channels of embedded audio for each video input (or output). The hybrid MADI input cards have one MADI input (64 audio channels) and the hybrid MADI output cards have two MADI outputs (64 channels each).

The 'Crosspoints' page displays the 'Audio Diagnostics' level for NV8500 routers uniquely:

Destination	Source	Locked	Protected	LID	Status
1 (1.1)	1 (1.1)	<input type="checkbox"/>	<input type="checkbox"/>	0	
2 (1.2)	1 (1.1)	<input type="checkbox"/>	<input type="checkbox"/>	0	
3 (1.3)	1 (1.1)	<input type="checkbox"/>	<input type="checkbox"/>	0	
4 (1.4)	1 (1.1)	<input type="checkbox"/>	<input type="checkbox"/>	0	
5 (1.5)	1 (1.1)	<input type="checkbox"/>	<input type="checkbox"/>	0	
6 (1.6)	169 (11.9)	<input type="checkbox"/>	<input type="checkbox"/>	0	Success
7 (1.7)	1 (1.1)	<input type="checkbox"/>	<input type="checkbox"/>	0	
8 (1.8)	1 (1.1)	<input type="checkbox"/>	<input type="checkbox"/>	0	
9 (1.9)	1 (1.1)	<input type="checkbox"/>	<input type="checkbox"/>	0	
10 (1.10)	1 (1.1)	<input type="checkbox"/>	<input type="checkbox"/>	0	
11 (1.11)	1 (1.1)	<input type="checkbox"/>	<input type="checkbox"/>	0	
12 (1.12)	1 (1.1)	<input type="checkbox"/>	<input type="checkbox"/>	0	
13 (1.13)	1 (1.1)	<input type="checkbox"/>	<input type="checkbox"/>	0	
14 (1.14)	1 (1.1)	<input type="checkbox"/>	<input type="checkbox"/>	0	
15 (1.15)	1 (1.1)	<input type="checkbox"/>	<input type="checkbox"/>	0	
16 (1.16)	1 (1.1)	<input type="checkbox"/>	<input type="checkbox"/>	0	
17 (2.1)	1 (1.1)	<input type="checkbox"/>	<input type="checkbox"/>	0	
18 (2.2)	1 (1.1)	<input type="checkbox"/>	<input type="checkbox"/>	0	
19 (2.3)	1 (1.1)	<input type="checkbox"/>	<input type="checkbox"/>	0	
20 (2.4)	1 (1.1)	<input type="checkbox"/>	<input type="checkbox"/>	0	
21 (2.5)	1 (1.1)	<input type="checkbox"/>	<input type="checkbox"/>	0	
22 (2.6)	1 (1.1)	<input type="checkbox"/>	<input type="checkbox"/>	0	
23 (2.7)	1 (1.1)	<input type="checkbox"/>	<input type="checkbox"/>	0	
24 (2.8)	1 (1.1)	<input type="checkbox"/>	<input type="checkbox"/>	0	
25 (2.9)	1 (1.1)	<input type="checkbox"/>	<input type="checkbox"/>	0	

The 'Current' table lists the port numbers normally but also lists them, in grey text, in parentheses, using *m.n* notation, where

m is a video port

n is one of the 16 embedded audio channels for video port *m*.

For instance, audio input 169 was taken to audio output 6. The *m.n* notation for port 169 is 11.9, meaning the 9th audio channel for video port 11.

(MRC displays this notation only for the 'Audio Diagnostic' level.)

When performing takes in the audio diagnostic level, you can enter input port numbers in *m.n* notation or plain notation as you prefer. For instance, port 37 is also known as port 3.5. You can enter that port either way.

Caveats

The *m.n* notation is useful, but it applies only to the audio diagnostic level. It does not apply to standard input and output or to MAD1 input and output. (It is also never present for routers other than the NV8500 series.)

First Caveat

MRC displays, for the audio diagnostics level, the entire audio space of the router as if it were fully populated with embedder and disembedder cards. For an NV8576-Plus, for instance, that space is 18,432 outputs. Disembedder cards and embedder cards do not use all the ports in the space. For example, an embedder card in slot 1 has 18 connectors, but only 16 inputs. The 9th

and 18th connectors are unused. Thus, ports 9.1 through 9.16 and 18.1 through 18.16 **do not exist** in the router. However, they are listed in the 'Current' table as if they did exist.

You might be tempted to route to these ports. MRC will let you do it, but in the router, nothing will happen.

You must remember that every ninth disembedder connector and every ninth embedder connector goes unused. But the numbering is more complex than that. Refer to the NV8500 port diagrams (shipped with the router) for exact details of which ports are used and which are not.

Second Caveat

The port (sub)space of any input card is 144 audio ports. MADi input cards provide 64 input ports. The remaining 80 ports of the card are unused.

The port (sub)space of any output card is 288 audio ports. MADi output cards provide 128 output ports. The remaining 160 ports of the card are unused.

MRC does not indicate unused (or unusable) ports, and in fact allows you to route to or from unused ports. In the actual router, nothing will happen.

Using the Crosspoints Page

You can use the 'Crosspoints' page to view or set crosspoints (i.e., perform "takes") on any router level. You can also save and load crosspoint matrix data.

Crosspoint changes you make in this page are immediately made in the crosspoint matrix of the router.

The **Current**, **History** and **Salvo** tabs in the upper region display similar crosspoint information:

Column	Description
Destination	The number of a router output in the level that is displayed. (The term <i>destination</i> means "output" and does not mean an NV9000 destination.)
Source	The number of a router input in the level that is displayed. (The term <i>source</i> means "input" and does not mean an NV9000 source.)
Locked	A check in a checkbox in this column means the output is locked. If the checkbox is clear, the output is unlocked.
Protected	A check in a checkbox in this column means the output is protected. If the checkbox is clear, the output is not protected.
LID	An identification number for the user that applied a lock or protect.
Status	When a take is performed, the column indicates the success of the take. You can hover your mouse over an entry in the column to show the time the take occurred and a summary of the take.

The **History** tab features an 'Undo History' section for selecting previous crosspoint states. (See [History Tab](#) on page 94.)





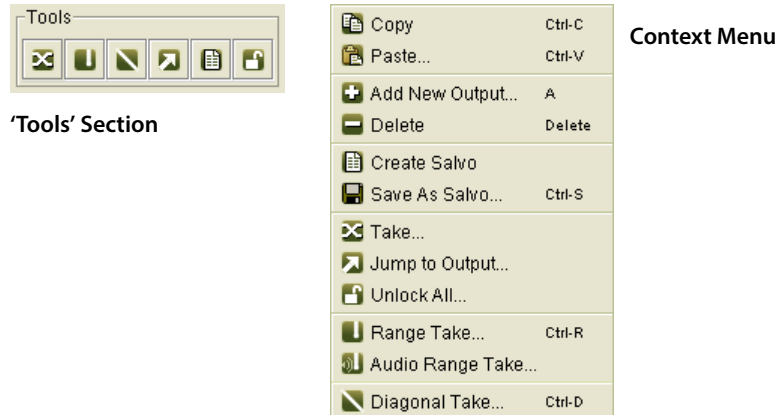

The **Incrementing Takes** tab lets you perform multiple takes in sequence. (See [Incrementing Takes Tab](#) on page 92 for details.)





Icons and Context Menu Options

Icons appear in the 'Tools' section of the 'Current' and 'History' tabs. The context menu (obtained by right-clicking within the work area of the tab) has a set of commands represented by icons:



Commands that cannot be executed on the currently active tab are disabled (greyed out). The following is a description of all icons and context menu commands:

Menu Option	Icon	Description
Copy		Copies the entire currently displayed crosspoint matrix (to the Windows clipboard). You can copy the crosspoint matrix from the 'Current', 'History', or 'Salvo' tab and paste the data into a 'Current' or 'Salvo' tab, or into an Excel file. See Copying and Pasting Crosspoint Data on page 98.
Paste		Pastes the clipboard contents (a currently copied crosspoint matrix) into the 'Current' or 'Salvo' tab. You cannot paste into the 'History' tab. You can paste data copied from the 'Current', 'History' or 'Salvo' tab, or from an Excel file. See Copying and Pasting Crosspoint Data on page 98.
Add New Output		Adds a new output to a salvo. Each salvo row represents an output with its input. See Creating and Updating a Salvo on page 103.
Delete		Removes an output (and its input) from a salvo. See Creating and Updating a Salvo on page 103.
Create Salvo		Opens a new 'Salvo' tab that is a "snapshot" of the crosspoint matrix in the 'Current' tab. Any changes you make in a 'Salvo' tab are <i>not</i> sent to the router's control card (unless you click the 'Crosspoint' button in the 'Tools' section). See Creating and Updating a Salvo on page 103.
Save As Salvo		Saves the salvo in the currently displayed tab as a salvo file for later use. This command performs the same function as the Save As Salvo button. See Creating and Updating a Salvo on page 103.
Crosspoint (see the note following this table)		This button copies a salvo's crosspoint data or history crosspoint data to the router's crosspoint matrix.

Menu Option	Icon	Description
Jump to Output		Opens the 'Jump to Output' dialog. Using this dialog, you can immediately go to a specific destination in the crosspoint matrix. See Locating Outputs on page 84.
Unlock All		Releases <i>all</i> locks and protects on <i>all</i> levels. Locks and protects are set in the router control system. You cannot set locks or protects in MRC. See Locks and Protects on page 78.
Range Take		Opens the 'Range Take' dialog. Using this dialog, you can connect one <i>video</i> input to a range of outputs. See Range Takes on page 88.
Audio Range Take		Opens the 'Audio Range Take' dialog. Using this dialog, you can connect one audio input to a range of physical outputs. See Range Takes on page 88.
Diagonal Take		Opens the 'Diagonal Take' dialog. Using this dialog, you can connect a contiguous range of inputs to a range of physical outputs. For example, input 1 to output 1, input 2 to output 2, and so on. You can click Reverse in the dialog to obtain a reverse diagonal take. See Diagonal Takes on page 90.

Note: the 'Crosspoint' button might be labeled a "Take" button in MRC. It sends crosspoint data, in a block, to the router's crosspoint matrix.

Locating Outputs

A crosspoint matrix can include thousands of inputs and outputs. Scrolling to find a portion of a crosspoint matrix or a specific destination can be time-consuming. To help make locating a destination easier, the 'Crosspoints' page features two tools: an *Output Filter* and a *Jump to Output* dialog.

Output Filter

The 'Output Filter' lets you limit the range of outputs that appear in the 'Current' and 'Salvo' tabs. To select a range of outputs, enter the beginning output and an ending output in the 'Min' and 'Max' fields below the table.

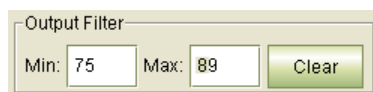

The 'Output Filter' is for viewing purposes only; it does *not* affect the size of the actual crosspoint in the router. Use the 'Clear' button to reset the range to include all outputs.

Jump to Output Dialog

The 'Jump to Output' dialog takes you to a specific destination. Simply enter an output number in the field provided and click OK. The row listing the destination is highlighted and is positioned to appear on the currently open tab.

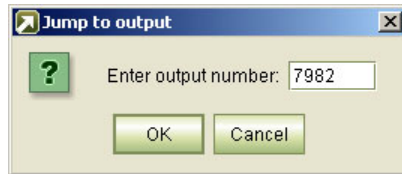

To open the 'Jump to output' dialog, either click the **Jump to Output** icon:



or select **Jump to Output** from the context menu.

Selecting a Level

Crosspoints are viewed on one level at a time and crosspoint connections are made on one level at a time.

To select a level, use the 'Level' drop-down menu at the bottom of the currently displayed crosspoint matrix:

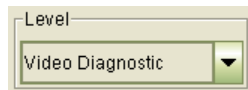

MRC provides two classes of levels:

- Router levels.

Router levels are those that you configure in the 'Routers Level' page and are listed by level number and signal type. (See [Router Levels Page](#) on page 37.)

- Diagnostic levels.

Diagnostic levels span the router's entire matrix space and are independent of any levels (or partitions) you have defined.

The diagnostic levels available depends on the signal types the router can switch. The following is a list of all possible diagnostic levels:

- **Audio Diagnostic**— all audio outputs, covering the 16 audio channels embedded in video signals. This is for NV8500 hybrid routers only.
- **Video Diagnostic**— all video outputs.
- **Monitor Diagnostic**— all monitor outputs. (See the router's documentation for information on monitor signals.)
- **Mono Audio Diagnostic**— all inputs and outputs that are mono audio channels on non-hybrid routers.

Note: the 'Crosspoints' page lists only diagnostic levels for virtual control cards.

Viewing a Crosspoint Matrix

Using the 'Crosspoints' page, you can view the crosspoint matrix for any level on any NVISION series router known to MRC. The page presents a table, one output per row.

You can select the level to view in the 'Current' tab or in a 'Salvo' tab.

How to View a Crosspoint Matrix

- 1 Go to the 'Crosspoints' page. From the **Control Cards** table at the bottom of the page, select a control card.
- 2 Select a level from the 'Level' drop-down menu at the bottom of the table. MRC displays the matrix for that level.

Null Audio Source

- ▲ The null audio source is a feature available only in NV8500 hybrid routers and applies only to those routers that have at least one disembedder/embedder output card.

You can define a null audio source and up to 16 extended pass-through audio sources in the 'Router Levels' page. If you take the null audio source to an audio output, the crosspoint table reports the fact in the 'Source' field for the output:

Crosspoints			
Current	History	Incrementing Takes	Single Takes
Destination	Source	Locked	
1	144 (Null Audio Source)	<input type="checkbox"/>	
2	2	<input type="checkbox"/>	
3	3	<input type="checkbox"/>	
4	144 (Null Audio Source)	<input type="checkbox"/>	
5	144 (Null Audio Source)	<input type="checkbox"/>	
6	6	<input type="checkbox"/>	
7	7	<input type="checkbox"/>	
8	8	<input type="checkbox"/>	
9	9	<input type="checkbox"/>	

See [Embedded Group Control](#) on page 141 for more information.

Pass-Through Sources

- ▲ Pass-through audio is a feature available only in NV8500 hybrid routers and applies only to those routers that have at least one disembedder/embedder output card.

You can define a basic pass-through audio source and up to 16 extended pass-through audio sources in the 'Router Levels' page. If you take a pass-through source to an audio output, the crosspoint table reports the fact in the 'Source' field for the output:

Current	History	Incrementing Takes	Single Takes			
Destination	Source	Locked	Protected	LID	Status	
1	1	<input type="checkbox"/>	<input type="checkbox"/>	11		
2	2	<input type="checkbox"/>	<input type="checkbox"/>	11		
3	3	<input type="checkbox"/>	<input type="checkbox"/>	11		
4	129 (Pass Thru Shuffle)	<input type="checkbox"/>	<input type="checkbox"/>	11		
5	130 (Pass Thru Shuffle)	<input type="checkbox"/>	<input type="checkbox"/>	11		
6	14	<input type="checkbox"/>	<input type="checkbox"/>	11		
7	143 (Pass Thru Source)	<input type="checkbox"/>	<input type="checkbox"/>	11		
8	143 (Pass Thru Source)	<input type="checkbox"/>	<input type="checkbox"/>	11		
9	143 (Pass Thru Source)	<input type="checkbox"/>	<input type="checkbox"/>	11		
10	10	<input type="checkbox"/>	<input type="checkbox"/>	11		
11	11	<input type="checkbox"/>	<input type="checkbox"/>	11		

Where the basic pass-through source has been taken, the 'Source' field reports "(Pass-Thru Source)". Where an extended pass-through source has been taken, the 'Source' field reports "(Pass-Thru Shuffle)".

The preceding illustration shows a 'Synchronous Audio' crosspoint view — a "mono" view. If you switch to a 'Synchronous Stereo Audio' crosspoint view, the same data appear somewhat differently:

Destination	Source	Locked	Protected	LID	Status
1	1		<input type="checkbox"/>	11	
2 - Breakaway	2		<input type="checkbox"/>	11	
3 - Breakaway	130 (Pass Thru Shuffle)		<input type="checkbox"/>	11	
4	143 (Pass Thru Source)		<input type="checkbox"/>	11	
5 - Breakaway	143 (Pass Thru Source)		<input type="checkbox"/>	11	
6	6		<input type="checkbox"/>	11	
7	7		<input type="checkbox"/>	11	

In the stereo view, the 'Destination' field reports "breakaway" when the two channels of a stereo pair have different sources. The 'Source' field reports the pass-through source number when it is the source for the first channel of a stereo pair or when it is the source for both channels of the stereo pair.

See [Pass-Through Sources](#) on page 142 for more information.

Performing Takes

Using the 'Crosspoints' page, you can perform "takes." An individual take connects an input to an output on a selected level.

Takes in MRC are useful for testing a crosspoint matrix.

Note

Any changes made in the 'Current' tab are also immediately executed in the actual crosspoint matrix of the router.

Any changes made in a 'Salvo' tab do not affect the router (until you click the 'Crosspoint' button which does write the crosspoint data to the router).

You can perform single takes, range takes, and diagonal takes. If your router supports both video and audio, you can perform takes on the video or the audio levels.

Single Input to Single Output

The 'Current' tab and 'Salvo' tabs (if present) allow you to switch a single input to a single output simply by changing the input number in the 'Source' field associated with the output.

How to Take a Single Input to a Single Output

- 1 Go to the 'Crosspoints' page. From the **Control Card** table, at the bottom of the page, select a control card.
- 2 Select a level from the 'Level' drop-down list. The crosspoint matrix for that level appears in the displayed table.
- 3 In the row representing the output (in the 'Destination' column) to which you want to route a new source, click in the 'Source' field to activate it.

- 4 Enter the number of the new input. Then press <enter> or <tab> or click anywhere outside the cell. The take is immediate. The 'Status' field displays the status of the take, which is usually 'Success'.

Range Takes

A range take switches a single input to multiple outputs. Input 1 could be switched to outputs 1 through 132, for example. The outputs can be contiguous or non-contiguous.

You can perform a range take on any level. The method is the same on any level.

What is known as an "Audio Range Take" (available through the context menu) is a special case and applicable only to the NV8500 hybrid routers.

What the audio range take does is switch all 16 audio channels of a video channel with embedded audio at one time. The input and the outputs are *video* ports, regardless of what level you are viewing. (The video is not switched.)

Note that a range take on an audio level is *not* the same thing as an 'Audio Range Take'!

How to Perform a Range Take

- 1 Go to the 'Crosspoints' page. From the **Control Cards** table at the bottom of the page, select a control card.
- 2 Select a level from the 'Level' drop-down menu. The crosspoint matrix for that level appears.
- 3 (Optional) Select outputs, contiguous or non-contiguous, in the displayed table. The take will be limited to the selected outputs.
- 4 Click the **Range Take** icon or select **Range Take** from the context menu. The 'Range Take' dialog appears:

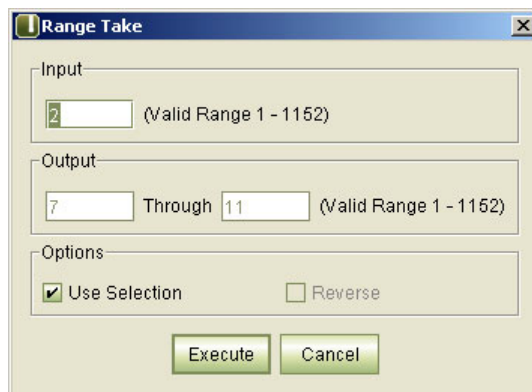

Range take on video level (NV8576-Plus)

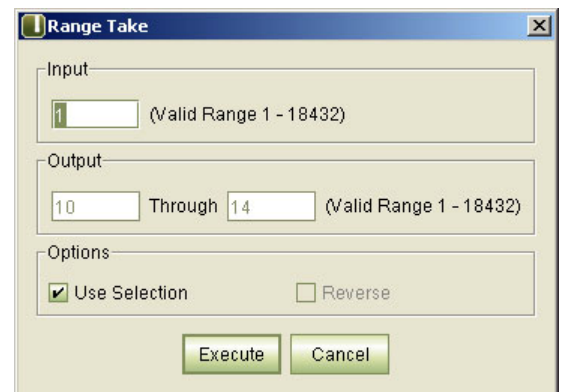

Range take on audio level (NV8576-Plus)

- 5 In the 'Input' field, enter the input to be switched to the destinations.
- 6 If you made an output selection (in step 3), the dialog appears with suggested values that are based on your selection. You can leave the 'Use Selection' check box checked and the range take will apply to your exact selection.

Otherwise, enter a range of outputs in the 'Output' section. The range of valid destinations appears at the right. Enter a starting number in the left-hand field and an ending number in the right-hand field. All outputs in that range are selected.

Note: the 'Reverse' checkbox is always disabled.

- 7 Click **Execute**. The take is performed. Click **Cancel** to leave the dialog without performing a range take.
- 8 The affected entries in the 'Status' column of the displayed crosspoint matrix show the status of each output switched.

Keep in mind that for the NV8500 hybrid routers, some video and audio ports in the list do not actually exist. Takes to or from these ports are physical "no-ops." For example, the 9th port of any disembedder card is vacant. The 16 audio ports that would be associated with it do not exist.

How to Perform an "Audio Range Take"

An audio range take is a special case, applicable only to NV8500 hybrid routers, that switches all 16 embedded audio channels of video ports. The input and outputs are video ports, regardless of what level you are viewing.

- 1 Go to the 'Crosspoints' page. From the **Control Cards** table at the bottom of the page, select a control card.
- 2 You do not need to select a level.
- 3 (Optional) Select outputs, contiguous or non-contiguous, in the displayed table. The take will be limited to the selected outputs.
- 4 Select **Audio Range Take** from the context menu. The 'Audio Range Take' dialog appears:

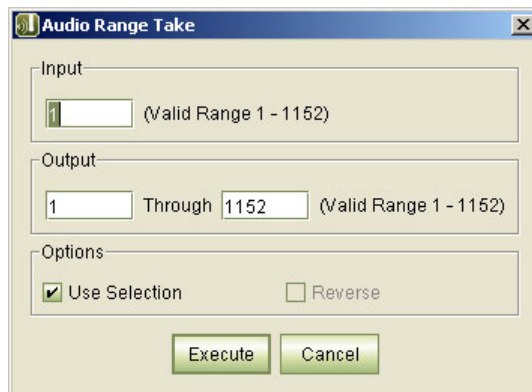

- 5 In the 'Input' field, enter the input to be switched to the destinations.
- 6 If you made an output selection (in step 3), you can leave the 'Use Selection' check box checked and the range take will apply to your exact selection.
Otherwise, enter a range of outputs in the 'Output' section. The range of valid destinations appears at the right. Enter a starting number in the left-hand field and an ending number in the right-hand field. All outputs in that range are selected.
Keep in mind that the input and the outputs in this dialog are video ports. The take will switch the audio (all 16 channels) for these video ports.
Note: the 'Reverse' checkbox is always disabled.
- 7 Click **Execute**. The take is performed. Click **Cancel** to leave the dialog without performing a range take.
- 8 The affected entries in the 'Status' column of the displayed crosspoint matrix show the status of each output switched.

Keep in mind that for the NV8500 hybrid routers, some video and audio ports in the list do not actually exist. Takes to or from these ports are “no-ops.” For example, the 9th port of any disem-bedder card is vacant. The 16 audio ports that would be associated with it do not exist.

Diagonal Takes

A diagonal take connects inputs M to outputs N , in *ascending* order, given an input starting point that you specify:

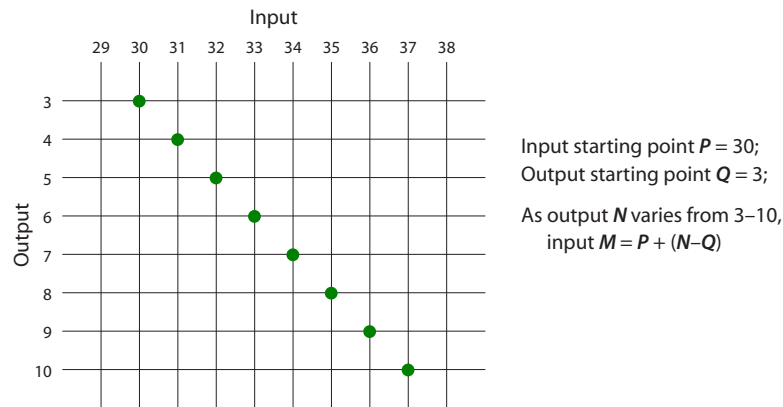

A reverse diagonal take connects inputs M to outputs N , in *descending* order, given an input starting point that you specify:

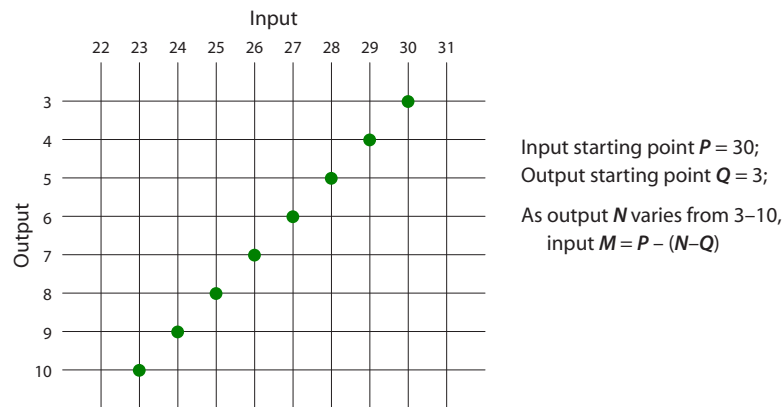

If the resulting input would fall out of the absolute range of the crosspoint matrix, an individual take is not performed. MRC will perform as many takes, in the range you specify, as it can.

You can perform diagonal and reverse diagonal takes in the ‘Current’ tab or in a ‘Salvo’ tab.

How to Perform a Diagonal Take

- 1 Go to the ‘Crosspoints’ page. From the **Control Cards** table, at the bottom of the page, select a control card.
- 2 Select a level from the ‘Level’ drop-down menu. The crosspoint matrix for that level appears.
- 3 (Optional) Select *contiguous* outputs in the displayed table.

- Click the **Diagonal Take** icon or select **Diagonal Take** from the context menu. The 'Diagonal Take' dialog appears.

- In the 'Input' section, enter a starting input number.
- If you made an output selection (in step 3), the dialog appears with suggested values that are based on your selection. You can leave the 'Use Selection' check box checked and the range take will apply to your selection.
Otherwise, enter a range of outputs in the 'Output' section. The range of valid destinations appears at the right. Enter a starting number in the left-hand field and an ending number in the right-hand field. All outputs in that range are selected.
- (Optional) Check the **Reverse** check box to perform a *reverse* diagonal take.

A diagonal take counts inputs *upward* from the starting point.

Destination	Source	Locked	Protected	LID	Status
3	30	<input type="checkbox"/>	<input type="checkbox"/>	0	Success
4	31	<input type="checkbox"/>	<input type="checkbox"/>	0	Success
5	32	<input type="checkbox"/>	<input type="checkbox"/>	0	Success
6	33	<input type="checkbox"/>	<input type="checkbox"/>	0	Success
7	34	<input type="checkbox"/>	<input type="checkbox"/>	0	Success
8	35	<input type="checkbox"/>	<input type="checkbox"/>	0	Success
9	36	<input type="checkbox"/>	<input type="checkbox"/>	0	Success
10	37	<input type="checkbox"/>	<input type="checkbox"/>	0	Success
11	141	<input type="checkbox"/>	<input type="checkbox"/>	0	
12	1	<input type="checkbox"/>	<input type="checkbox"/>	0	
13	136	<input type="checkbox"/>	<input type="checkbox"/>	0	

A reverse diagonal take counts inputs *downward* from the starting point.

Destination	Source	Locked	Protected	LID	Status
3	30	<input type="checkbox"/>	<input type="checkbox"/>	0	Success
4	29	<input type="checkbox"/>	<input type="checkbox"/>	0	Success
5	28	<input type="checkbox"/>	<input type="checkbox"/>	0	Success
6	27	<input type="checkbox"/>	<input type="checkbox"/>	0	Success
7	26	<input type="checkbox"/>	<input type="checkbox"/>	0	Success
8	25	<input type="checkbox"/>	<input type="checkbox"/>	0	Success
9	24	<input type="checkbox"/>	<input type="checkbox"/>	0	Success
10	23	<input type="checkbox"/>	<input type="checkbox"/>	0	Success
11	141	<input type="checkbox"/>	<input type="checkbox"/>	0	
12	1	<input type="checkbox"/>	<input type="checkbox"/>	0	
13	136	<input type="checkbox"/>	<input type="checkbox"/>	0	

- 8 Click **Execute**. The take is performed. Click **Cancel** to leave the dialog without performing any takes.
- 9 The affected entries in the 'Status' column of the displayed crosspoint matrix show the status of each output switched.

Keep in mind that for the NV8500 hybrid routers, some video and audio ports in the list *do not actually exist*. Takes to or from these ports are "no-ops." For example, the 9th port of any disem-bedder card is vacant. The 16 audio ports that would be associated with it do not exist.

Incrementing Takes Tab

Using the 'Incrementing Takes' tab, you can perform several automated take sequences that can run simultaneously and for an indefinite period. These sequences are useful for testing.

This is a sample of the 'Incremental Takes' table.

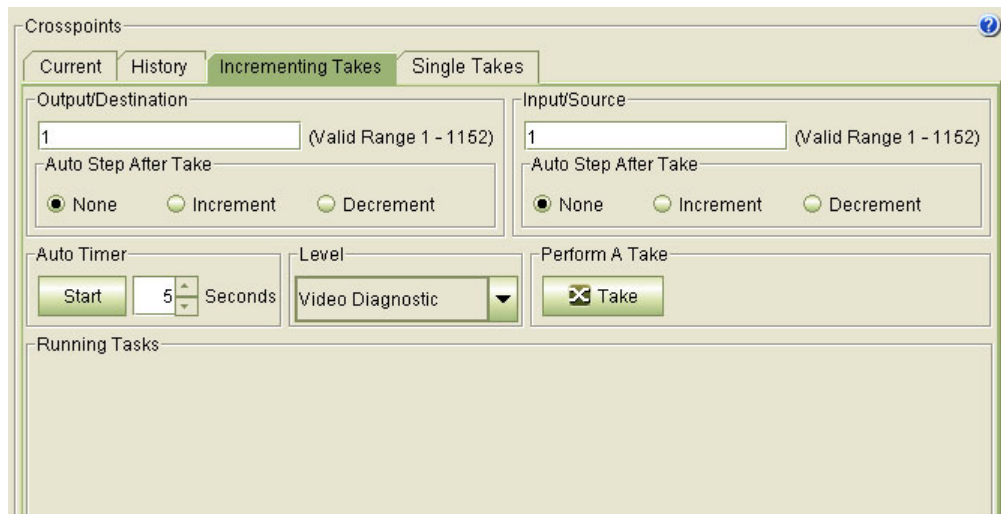

In the Output/Destination section, you can indicate the starting output and whether a take sequence increments or decrements from that point. If you choose 'None', the output for the takes does not vary.

The 'Input/Source' section has the same controls as the 'Output/Destination' section.

The 'Auto Timer' section allows you to set the interval between takes (in seconds) and to start the automated sequence. (You can step a sequence manually as long as you do not click 'Start'.)

The 'Level' section has a drop-down menu in which you can select a level on which to perform a take sequence.

The 'Perform a Take' section has a 'take' button with which you can manually step through the take sequence (as long as the sequence is not running on a timer). When you click the take button, MRC gives you the result next to the button:

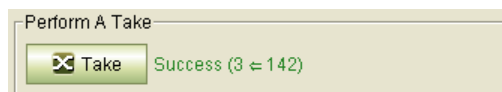

Incremental takes let you to perform one or more takes output-by-output and input-by-input. Each take can be performed manually (using the take button) or automatically using the timer.

You can run more than one take sequence at a time, allowing you to test multiple levels simultaneously. The 'Running Tasks' section shows the different take sequences that are running. The sequences run forever or until you click the 'Stop' button in the 'Running Tasks' section.

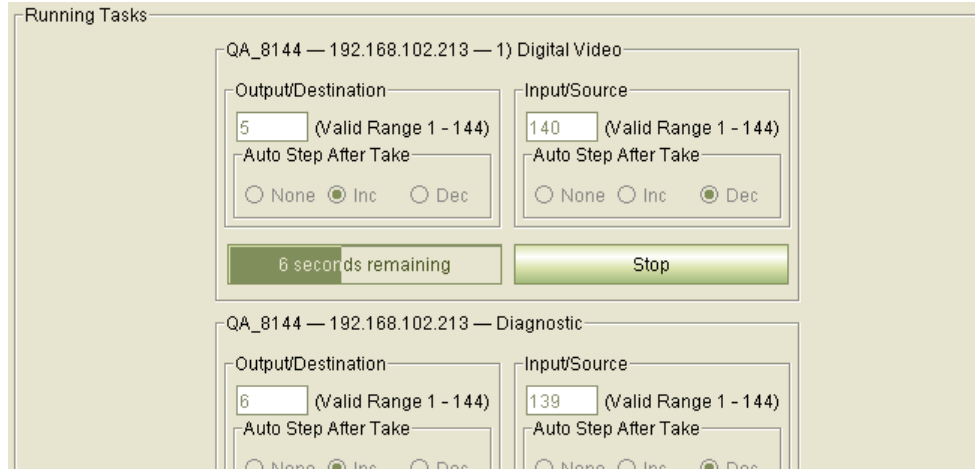

In the lower right corner of the 'Crosspoints' page, a progress bar lists how many tasks are running and indicates progress by a moving green rectangle:



Each task sequence shows you its current take values and shows you the timer running in real time. Each take sequence also has a 'Stop' button. It is with this button that you can stop the take sequence.

How to Perform Incremental Takes

- 1 Go to the 'Crosspoints' page. From the **Control Cards** table, at the bottom of the page, select a control card.
- 2 Click the **Incrementing Takes** tab.
- 3 Select a level from the 'Level' drop-down menu. The takes in the take sequences you are defining are applied on that level.
- 4 In the 'Output/Destination' section, enter a starting output number. The takes will occur within the full range of router outputs which is indicated in the section.
- 5 In the 'Input/Source' section, enter a starting input number. The takes will occur within the full range of router inputs which is indicated in the section.
- 6 Determine whether the inputs and outputs will increment or decrement.
 - Inc**—The input or output increments (by 1) at each take.
 - Dec**—The input or output decrements (by 1) at each take.
 - None**—The input or output remains unchanged.
- 7 If you want to run the take sequence automatically, set the timer, in the 'Auto Timer' section, to the number of seconds after which each take is performed. For example, if you select 5, a take will automatically occur every 5 seconds. Then click "Start" in the 'Auto Timer' section. A descriptor of the take sequence will appear in the 'Running Tasks' section.

Otherwise, the take sequence is manual. Click the take button in the 'Perform a Take' section every time you want to step the take sequence.

- 8 If you initiated an automatic take sequence, click 'Stop' when you want to terminate the sequence. Otherwise the take sequence will run indefinitely (and the inputs and outputs will wrap around to the beginning or the end of the router's ranges if you let it run long enough).
- 9 After you start one automatic sequence, you can start additional sequences, automatic or manual.

History Tab

The 'Crosspoints' page lets you set a crosspoint matrix to any of its previous states. Each time a take, a range take, or a diagonal take is performed, a corresponding record is added to the 'History' tab.

Destination	Source	Locked	Protected	LID
1	32	<input type="checkbox"/>	<input type="checkbox"/>	0
2	31	<input type="checkbox"/>	<input type="checkbox"/>	0
3	30	<input type="checkbox"/>	<input type="checkbox"/>	0
4	29	<input type="checkbox"/>	<input type="checkbox"/>	0
5	28	<input type="checkbox"/>	<input type="checkbox"/>	0
6	27	<input type="checkbox"/>	<input type="checkbox"/>	0
7	26	<input type="checkbox"/>	<input type="checkbox"/>	0
8	25	<input type="checkbox"/>	<input type="checkbox"/>	0
9	24	<input type="checkbox"/>	<input type="checkbox"/>	0
10	23	<input type="checkbox"/>	<input type="checkbox"/>	0
11	22	<input type="checkbox"/>	<input type="checkbox"/>	0
12	21	<input type="checkbox"/>	<input type="checkbox"/>	0
13	20	<input type="checkbox"/>	<input type="checkbox"/>	0
14	14	<input type="checkbox"/>	<input type="checkbox"/>	0
15	15	<input type="checkbox"/>	<input type="checkbox"/>	0
16	16	<input type="checkbox"/>	<input type="checkbox"/>	0
17	17	<input type="checkbox"/>	<input type="checkbox"/>	0
18	18	<input type="checkbox"/>	<input type="checkbox"/>	0
19	19	<input type="checkbox"/>	<input type="checkbox"/>	0
20	20	<input type="checkbox"/>	<input type="checkbox"/>	0
21	21	<input type="checkbox"/>	<input type="checkbox"/>	0
22	22	<input type="checkbox"/>	<input type="checkbox"/>	0

The 'History' tab lists up to 50 activities (the 50 most recent) in the 'Undo History' section.

The 'Undo History' section allows you to select any state of any router — recent or old.

The 'Undo History' section is organized primarily by router, in the order in which you accessed the routers. Within a router, the history is organized by level, and within a level, by activity (such as a range take). The activities are simply numbered, the largest number being the oldest.

You can expand or collapse sections of the 'Undo History' section. Click a collapsed section (having a "+" marker) to expand it. Click an expanded section (having a "-" marker) to collapse it.

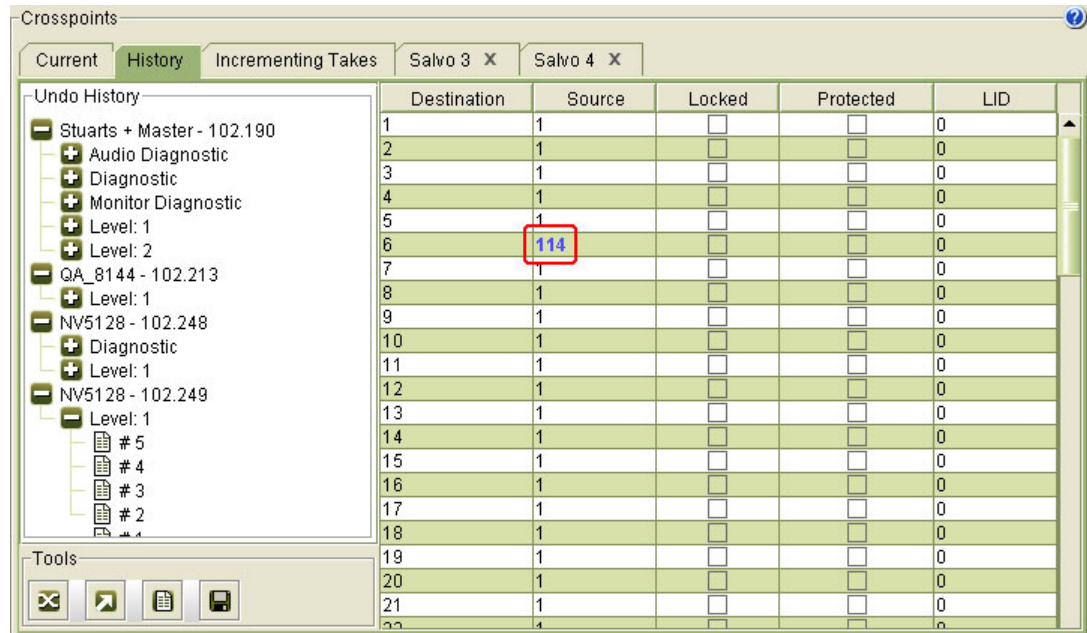

When you choose a crosspoint state, the details of the crosspoint matrix appear at the right. (You cannot make changes in this table.) Takes that were made in the selected crosspoint state are highlighted in bold, blue text.

How to Revert to a Previous Matrix State





- 1 Go to the 'Crosspoints' page. From the **Control Cards** table, at the bottom of the page, select a control card.
- 2 Click the 'History' tab.
- 3 Locate, and click the numbered entry in the 'Undo History' section that corresponds to the previous crosspoint matrix state you want. The details of the crosspoint matrix appear at the right if the 'History' tab.
- 4 Either click the **Crosspoint** icon



or select 'Take' from the context menu. This function sets the router's crosspoint matrix (on the level chosen in the 'Undo History' section) to the state you chose. The resulting crosspoint state can be viewed in the 'Current' tab.

The History Tools

The following is a description of icons in the 'Tools' section:

Menu Option	Icon	Description
Crosspoint (see the note following this table)		This button copies the currently displayed crosspoint data to the router's crosspoint matrix.
Jump to Output		Opens the 'Jump to Output' dialog. Using this dialog, you can immediately go to a specific destination in the crosspoint matrix.
Create Salvo		Opens a new 'Salvo' tab that is a "snapshot" of the crosspoint matrix in the 'History' tab.
Save As Salvo		Saves the currently displayed crosspoint data as a salvo file for later use. This command performs the same function as the Save As Salvo button.

Note: the 'Crosspoint' button sends crosspoint data, in a block, to the router's crosspoint matrix.

Single Takes Tab

The 'Single Take' tab of the 'Crosspoints' page lets you perform 2 functions:

- Single takes
- Chop takes

When you perform single takes, you have the option of toggling (manually) between the input you specify and the last input you specified. The output you specify remains the same when the takes toggle from one to the other.

A chop toggles a single output between one input and another, at a certain rate (expressed as a number of frames). The chop proceeds automatically: you start it and some time later, you stop it. Chop takes are generally used for diagnostics.

Single takes and chop takes are recorded in the logging pane of the 'Single Takes' tab. See the illustration that follows.

This is the 'Single Takes' tab:

Single Take

Output/Destination: 5 Input/Source: 2 Input Options: Toggle After Take Level: Video Diagnostic Action: Perform Take

Chop Take

Output/Destination: 5 Chop Input 1: 11 Chop Input 2: 22 Chop Frames: 15 Actions: Chop Take, Stop Chop

Log

```

11:08:08 AM:    5 <== 11 [Level=DIAGNOSTIC] QA_NV8140 - 192.168.102.213
11:07:54 AM: Started Chop 5 <== (11, 22) Interval:15 QA_NV8140 - 192.168.102.213
11:06:58 AM:    5 <== 3 [Level=DIAGNOSTIC] QA_NV8140 - 192.168.102.213
11:06:58 AM:    5 <== 2 [Level=DIAGNOSTIC] QA_NV8140 - 192.168.102.213
11:06:57 AM:    5 <== 3 [Level=DIAGNOSTIC] QA_NV8140 - 192.168.102.213
11:06:56 AM:    5 <== 2 [Level=DIAGNOSTIC] QA_NV8140 - 192.168.102.213
11:06:53 AM:    5 <== 3 [Level=DIAGNOSTIC] QA_NV8140 - 192.168.102.213
11:06:06 AM:    5 <== 2 [Level=DIAGNOSTIC] QA_NV8140 - 192.168.102.213
11:05:59 AM:    5 <== 1 [Level=DIAGNOSTIC] QA_NV8140 - 192.168.102.213

```

Network Frame Summary

Control Cards Network Levels

Edit	Online	Name	Type	IP Address	Expansion
<input type="radio"/>	Active	NV8256+	NV8256 Plus	192.168.102.138	Stand Alone
<input type="radio"/>	Active	NV8576	NV8576	192.168.102.152	Stand Alone
<input type="radio"/>	Standby	QA_8576+_MTR_SEC	NV8576	192.168.102.210	Stand Alone
<input type="radio"/>	Active	QA_8576+_MTR_SEC	NV8576	192.168.102.211	Stand Alone
<input checked="" type="radio"/>	Active	QA_NV8140	NV8140	192.168.102.213	Stand Alone

Refresh Summary Open Salvo... Save As Salvo...

How to Perform Single Takes

1 Go to the 'Single Takes' tab of the 'Crosspoints' page. Focus on the 'Single Take' section:

Single Take

Output/Destination: 5 Input/Source: 2 Input Options: Toggle After Take Level: Video Diagnostic Action: Perform Take

- 2 If you want successive single takes to toggle, check the 'Toggle After Take' check box.
- 3 Specify a level on which the take is to occur in the 'Level' drop-down list.
- 4 Specify an output in the 'Output/Destination' field. Specify an input in the 'Input/Source' field.
- 5 Click 'Perform Take'.
- 6 The take occurs and is recorded in the Log section. If the 'Toggle After Take' check box is checked, the input field reverts to what it was before the take occurred. Thus, you can toggle an output between two inputs manually.

How to Perform Chop Takes

- 1 Go to the 'Single Takes' tab of the 'Crosspoints' page. Focus on the 'Chop Take' section:

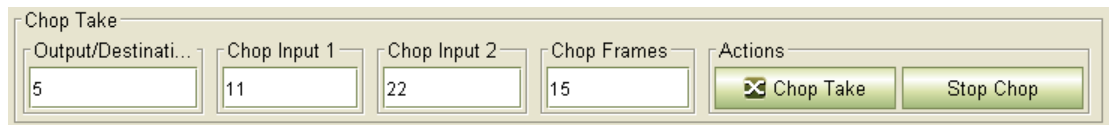

The screenshot shows a 'Chop Take' configuration window with the following fields and values:

Field	Value
Output/Destination	5
Chop Input 1	11
Chop Input 2	22
Chop Frames	15

Buttons: Chop Take, Stop Chop

- 2 Specify a level on which the take is to occur in the 'Level' drop-down list.
- 3 Specify an output in the 'Output/Destination' field.
- 4 Specify an input in the 'Chop Input 1' field. Specify another input in the 'Chop Input 2' field. (You could specify the same input if it suits your needs.)
- 5 Specify the chop frequency as a number of frames.
- 6 Click 'Chop Take'.
- 7 The chop takes begin and the event is recorded in the Log section.
- 8 To stop the chop takes, click 'Stop Chop'. The stop event is recorded in the Log section.

A chop lets you toggle an output between two inputs automatically and at a rate you specify.

Copying and Pasting Crosspoint Data

Using the **Copy** and **Paste** commands (available in the context menu) you can create additional crosspoint matrix states or update existing crosspoint matrices. These commands allow you to copy and paste within the 'Current' and 'Salvo' tabs, copy to Excel files, and copy from Excel files. Exporting to and importing from Excel gives you some diagnostic capability.

You can copy or paste sections of a crosspoint, contiguous or disjoint, as small as a single row, or you can copy or paste entire matrices.

Copy

To copy a portion of a crosspoint matrix (to the clipboard), select a set of rows in the displayed crosspoint matrix. Then type Ctrl-C or select **Copy** from the context menu.

To copy an entire crosspoint matrix (to the clipboard), deselect all rows in the displayed crosspoint matrix. Then type Ctrl-C or select **Copy** from the context menu.

Paste

To issue the paste command, type Ctrl-V or select **Paste** from the context menu.

When you use the **Paste** command, the 'Paste Crosspoints' dialog opens, displaying the outputs (and their inputs) that you copied previously. Using this dialog, you can preview the data to be pasted. (You cannot edit the data to be pasted.)

Pasting *merges* the crosspoint data on the clipboard with the target crosspoint matrix (whether it is the one in the 'Current' tab or in a 'Salvo' tab). If an output already exists, the output data are pasted onto the existing output. Outputs that do not already exist in the configuration are added.

Example

If a salvo has these crosspoints . . .

Destination	Source	Locked	Protected	LID	Status
8	137	<input type="checkbox"/>	<input type="checkbox"/>	0	
9	136	<input type="checkbox"/>	<input type="checkbox"/>	0	
10	135	<input type="checkbox"/>	<input type="checkbox"/>	0	

and the clipboard (and the 'Paste Crosspoints' dialog) show these crosspoints . . .

Left Column Contents:

Output/Destination Input/Source

Merge Options:

Use Selection Add new Outputs/Destinations

Sample Crosspoints:

Preview Final Result

Destination	Source	Locked	Protected	LID
4	141	<input type="checkbox"/>	<input type="checkbox"/>	0
6	139	<input type="checkbox"/>	<input type="checkbox"/>	0
8	137	<input type="checkbox"/>	<input type="checkbox"/>	0

then the resulting salvo acquires two new outputs.

Destination	Source	Locked	Protected	LID	Status
4	141	<input type="checkbox"/>	<input type="checkbox"/>	0	
6	139	<input type="checkbox"/>	<input type="checkbox"/>	0	
8	137	<input type="checkbox"/>	<input type="checkbox"/>	0	
9	136	<input type="checkbox"/>	<input type="checkbox"/>	0	
10	135	<input type="checkbox"/>	<input type="checkbox"/>	0	

The new entries are highlighted in blue.

The clipboard contained an entry for output 8. Because the salvo already had output 8, it is not a new entry.

You can copy from the 'Current', 'History', or 'Salvo' tabs, but you can paste only into the 'Current' or 'Salvo' tabs. The History tab is read-only.

It is not possible to add entries to the 'Current' view. The current view displays a router's crosspoint matrix and that cannot be changed. An attempt to add outputs to the crosspoint will be ignored.

It is certainly acceptable to add outputs to a salvo.

How to Copy and Paste Crosspoint Data

- 1 Go to the 'Crosspoints' page. From the **Control Cards** table, at the bottom of the page, select a control card.
- 2 Click on the 'Current', 'History' or 'Salvo' tab containing the data you want to copy.
- 3 Select any number of outputs (i.e., rows). Press **Ctrl + C** on your keyboard or select **Copy** from the context menu.
 Or, open an Excel file and copy the Excel data using Excel's copy command.
- 4 Select the 'Current' or 'Salvo' tab into which the data are to be pasted. (You cannot paste into the 'History' tab.)
- 5 (Optional) Select outputs, contiguous or non-contiguous. The paste result is restricted to the selected outputs.
- 6 Press **Ctrl + V** on your keyboard or select **Paste** from the context menu. The 'Paste Crosspoints' dialog appears:

Left Column Contents

Output/Destination Input/Source

Merge Options

Use Selection Add new Outputs/Destinations

Sample Crosspoints

Preview Final Result

Destination	Source	Locked	Protected	LID
4	141	<input type="checkbox"/>	<input type="checkbox"/>	0
6	139	<input type="checkbox"/>	<input type="checkbox"/>	0
8	137	<input type="checkbox"/>	<input type="checkbox"/>	0

OK Cancel

- 7 If you are pasting from an Excel file, and the Excel file lists sources in the left column and destinations in the right column, select the **Input/Source** radio button to rectify the data.
- 8 Check the **Use Selection** check box if outputs were selected in step 5 and you want to limit the paste operation to just those outputs.
 For example, if you had selected outputs 1–12 were selected, and the clipboard (and the Paste Crosspoints dialog) show outputs 10–18, the paste command is applied to the intersection, that is, outputs 10–12.

- 9 Check or uncheck the **Add new Outputs/Destinations** check box for the following results:
 - Checked — any outputs that do not already appear in the existing crosspoint matrix are added. Added outputs appear in blue.
 - Unchecked — only outputs that already exist in the configuration are pasted. The new outputs copy over the existing outputs of the same number.
- 10 Check **Preview Final Results** to view what the crosspoint matrix will look like after the paste occurs.
- 11 Click **OK**. The paste is executed.
 - If you are pasting into the 'Current' tab, the updated crosspoint data are sent to the crosspoint in the router.
 - If you are pasting into a 'Salvo' tab, the router's crosspoint is not affected. You can save or further update the salvo.

Using Salvos

MRC can take "snapshots" of a router's crosspoint matrices (one snapshot per level) and save them as a separate files. These "snapshots" are called salvos. If a system failure occurs, you can copy the salvo data to the router's crosspoint matrix, restoring it to a previous (and presumably known) state.

Salvos are also a time-saving tool. Identical crosspoint matrices can easily be sent to several crosspoint cards.

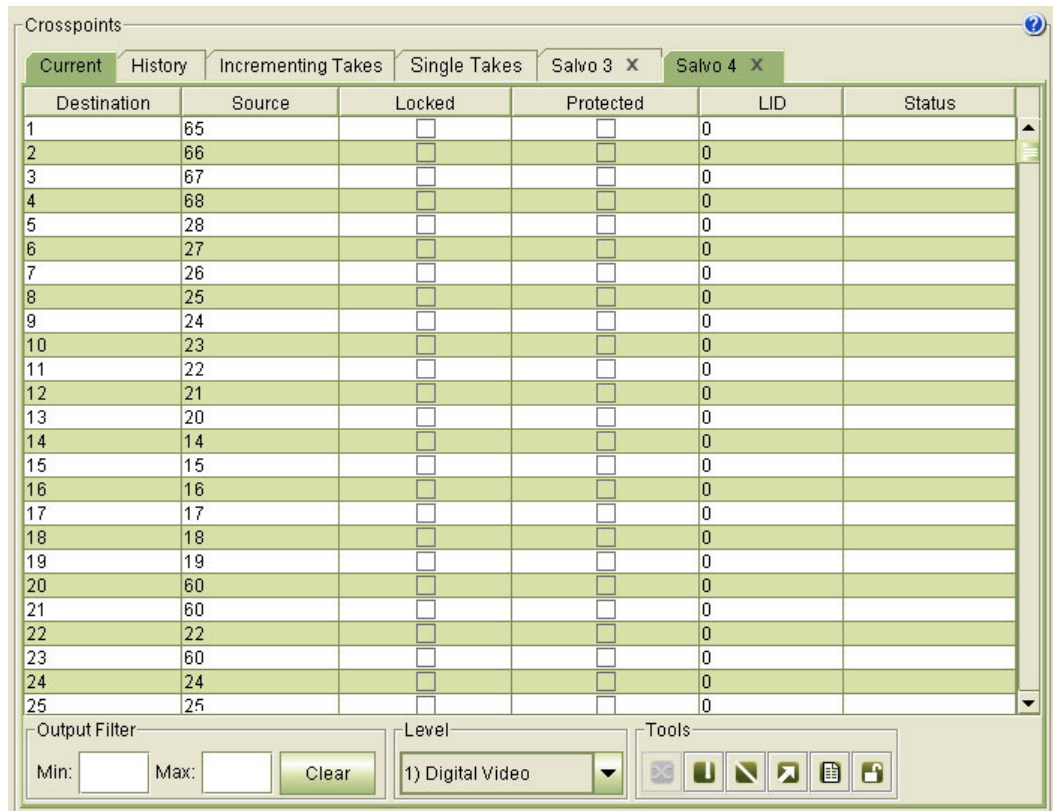

Salvos are viewable on 'Salvo' tabs, one salvo per tab, on the 'Crosspoints' page. Salvo commands are accessed through the *Tools* section or from the pop-up context menu (activated by right-clicking on an open tab).

This is a sample of a Salvo tab:



The following are descriptions of the salvo commands:

Command	Icon	Description
Copy		Copies the displayed crosspoint matrix, or selected outputs within it. The data can be copied from the 'Current', 'History', or 'Salvo' tab and can be copied to the 'Current' tab or into a 'Salvo' tab, or into an Excel file. See Copying and Pasting Crosspoint Data on page 98.
Paste		Pastes the currently output data into the 'Current' tab or into a 'Salvo' tab. You cannot paste into the 'History' tab, which is read only. You can paste data from the 'Current', 'History', or 'Salvo' tab, or from an Excel file. See Copying and Pasting Crosspoint Data on page 98.
Add New Output		Adds a new output to a salvo. Each row in the salvo represents an output. See Creating and Updating a Salvo on page 103.
Delete		Removes a row from a salvo. See Creating and Updating a Salvo on page 103.

Command	Icon	Description
Create Salvo		Creates, and opens, a new 'Salvo' tab displaying a "snapshot" of the crosspoint matrix that is open in the 'Current' tab. See Creating and Updating a Salvo on page 103.
Save As Salvo		Saves the crosspoint data in the 'Salvo' tab as a salvo file for later use. This command performs the same function as the Save As Salvo button at the bottom of the Crosspoints page. See Creating and Updating a Salvo on page 103.

Creating and Updating a Salvo

Salvos can be created at any time and saved for later use.

To create a salvo, click the **Salvo** button . . .



or click 'Create Salvo' in the context menu.

There are two kinds of results that you can expect when you create a salvo:

- If you have two or more rows selected in the displayed crosspoint matrix, the new salvo includes just those rows.
- If you have one row or no rows selected, the salvo becomes a complete copy of the displayed crosspoint matrix.

You can make changes to a salvo without affecting the router's crosspoint matrices in any way.

You can add rows to a salvo and delete rows from a salvo.

How to Create or Update a Salvo

- 1 Go to the 'Crosspoints' page. From the **Control Cards** table, at the bottom of the page, select a control card.
- 2 Either create a new salvo . . .
To create a salvo, click the **Salvo** button . . .



or click 'Create Salvo' in the context menu.

- 3 . . . or open an existing salvo.

Click an existing 'Salvo' tab.

Or, click **Open Salvo**, at the bottom of the page. In the 'Open' dialog that appears, browse to locate a salvo file and select the file. Click **Open**. The opened salvo will appear in a new 'Salvo' tab.

- 4 (Optional) Add an output to the salvo.

Choose **Add New Output . . .** from the context menu. The 'Add New Outputs' dialog appears.

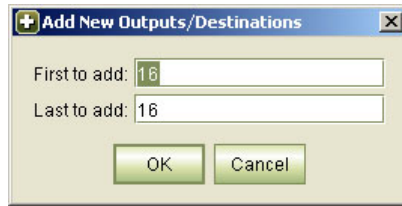

Enter the starting row and ending row you want to add in the 'First to add' and 'Last to add' fields, respectively. Click **OK**.

The outputs appear in the *Salvo* tab. Outputs that already exist are left unchanged.

The initial dialog suggests adding 1 row just above the last row in the salvo.

In the 'Salvo' table, enter an input number in the 'Source' field for each new row. (There is no point in having the row unless there is a source specified.)

- 5 (Optional) Remove an output (or outputs) from the salvo:

Select the row(s) representing the output(s) you want to remove.

Choose **Delete** from the context menu.

- 6 (Optional) Paste outputs from the 'Current' or 'History' tab, from another 'Salvo' tab, or from an Excel file.

See [Copying and Pasting Crosspoint Data](#) on page 98.

- 7 (Optional) Click **Save as Salvo**. A 'Save' dialog appears.

Click **Browse** to specify the location and name of the file. Salvo files are saved with the file extension *.salvo*. Click **Save**.

Opening a Salvo and Uploading its Crosspoint Data

Salvos can be opened and applied at any time. Exercise caution that the salvo you have opened contains the crosspoint data that you want. Uploading from a salvo to a router overwrites existing crosspoint data.

How to Upload Data from a Salvo

- 1 Go to the 'Crosspoints' page. From the 'Control Cards' table, at the bottom of the page, select a control card.
- 2 Click 'Open Salvo'. The 'Open' dialog appears.
- 3 Click **Browse** to locate a previously saved salvo file and click **Open**. (Salvo files have the extension *.salvo*.)
- 4 The crosspoint data from the salvo appear in a new 'Salvo' tab.
- 5 (Optional) Click the 'Crosspoint' button below the salvo table:



The button copies the salvo data to the router's crosspoint matrix. Be very careful that the salvo data are correct for the router's crosspoint matrix. You will receive a warning:

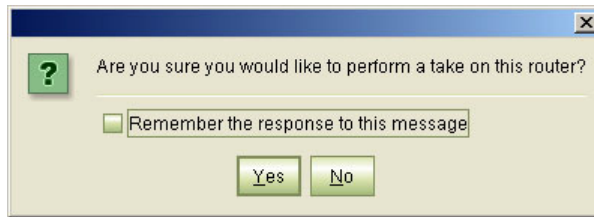

You can disable this message, but we recommend that you do not.

Deleting a Salvo

To delete a salvo from MRC, click the X in the salvo tab.

Salvos that are saved are text files with the extension .salvo. (You can open them with Notepad or Excel.) To delete a salvo file, locate the file in your computer's file system and use your normal method to delete the file.

Logs Page

The *Logs* page has two sections. At the bottom is a 'Network Frame Summary' that has two tables. The 'Control Cards' table in this region is for selecting a control card of the router for which you want to view the logs. At the top of the page are two scrollable windows that display the router's *startup* event log and its *running* event log.

The screenshot displays the Router Logs Page interface. It is divided into three main sections:

- Startup Log:** A scrollable window showing configuration parameters and system messages. Key parameters include:
 - cnfgPrtnSigType = 0x00 = 0 = I
 - cnfgMtrxRefMode = 0x00 = REDUNDANT
 - cnfgMtrxHdstbse1 = 0x02 = VREF1:1080p, VR
 - cnfgEnetEna = 0x02 = ENABLED
 - cnfgEnetIpAddr = 0xC0A86697 = 192.168.102.151
 - cnfgEnetSubnetMask = 0xFFFFFFFF00 = 255.255.255.0
 - cnfgEnetGatewayAddr = 0x00000000 = 0.0.0.0
 - cnfgExpType = 0x04 = MATCOM
 - cnfgExpRole = 0x00000002 = MASTER
 - cnfgExpInStart = 0x0001 = 1
 - cnfgExpInEnd = 0x0090 = 144
 - cnfgExpOutStart = 0x0001 = 1
 - cnfgExpOutEnd = 0x0120 = 288
 - cnfgDataNotLocked = 0xFF = LOCKED
- Running Log:** A scrollable window showing real-time system events. It includes statistics like:
 - updateCnt: 208, 215, 423
 - videoTsZeroCnt: 576, 0, 576
 - audioTsZeroCnt: 9216, 0, 9216
 - uiTakeCnt = 0
 - Multiple entries for CNvpeIPDiscovery::ParseEUDPMessage COMMAND_CHA
 - 00:00:00 cnfgStorewrschedule: updating EEPROM
 - 00:00:00 writeEe: EEPROM updated
- Network Frame Summary:** A table with two tabs: 'Control Cards' (selected) and 'Network Levels'. The 'Control Cards' tab contains the following data:

Select	Online	Name	Type	IP Address	Expansion
<input checked="" type="radio"/>	Active	Kevin's NV8280	NV8280	192.168.102.151	Stand Alone
<input checked="" type="radio"/>	Active	Jeremy's NV8280	NV8280	192.168.102.152	Stand Alone
<input type="radio"/>	Standby	Kevin's NV8280	NV8280	192.168.102.155	Stand Alone
<input checked="" type="radio"/>	Active	Stu's Master(P)	NV8576 Plus	192.168.102.190	Stand Alone
<input checked="" type="radio"/>	Standby	QA_8576+	NV8576 Plus	192.168.102.211	Expanded - Master
<input type="radio"/>	Standby	QA_8144	NV8144	192.168.102.212	Stand Alone
<input checked="" type="radio"/>	Active	QA_8144	NV8144	192.168.102.213	Stand Alone
<input checked="" type="radio"/>	Active	QA_8576+	NV8576 Plus	192.168.102.214	Expanded - Master

MRC updates the running log every 8 seconds. This information is primarily provided for support personnel as an aid in troubleshooting system failures.

You can save logs to your file system at any time, for future reference.

To display the most current information, click **Refresh Summary**, at the bottom of the page.

How to View Logs and Save a Log File

- 1 Go to the 'Logs' page. From the **Control Cards** table at the bottom of the page, select a control card.
- 2 (Optional) To save a log file, click **Save Logs to File**, at the bottom of the page. The 'Save' dialog appears.
In the 'Save' dialog, click **Browse** to specify the location and name of the file, and click **Save**.

System Status

The 'System Status' page presents the status of a router in a compact form. The page has two regions. At the bottom in the 'Network Frame Summary' which has 2 tabbed tables. Use the 'Control Cards' table to select a control card for the router for which you want to view status.

This is a view of the NV5128:

System Status

Control Card Status

Control Card: **EM0374**

Health: **Healthy**

State: **Active**

Card Slot: **Primary**

Last Timestamp: **687956040**

IP Address: **192.168.102.248**

CTRL 1 Protocol: **NV SERIAL**

Peer Card Status

Health: **PROBLEM**

State: **Standby**

Frame Information

Frame ID: **0x0E**

Device ID: **NV5128**

EE 1: **OK**

EE 2: **OK**

Video Reference 1: **OK**

Video Reference 2: **Missing**

Alarms

Alarm 1: **OFF - Major**

Alarm 2: **ON - Minor**

Alarm 3: **ON - Power Supply**

Alarm 4: **ON - Video Reference**

Alarm 5: **OFF - AES Ref Clock**

Alarm 6: **OFF - Fan & Temperature**

Alarm 7: **OFF - Active Card Health**

Power Supplies

PS 1: **Missing**

PS 2: **OK**

Fans

Fan 1: **OK**

Fan 2: **OK**

Fan 3: **OK**

Network Frame Summary

Control Cards | Network Levels

Select	Online	Name	Type	IP Address	Expansion
<input checked="" type="radio"/>	Active	Kevin's NV8280	NV8280	192.168.102.151	Stand Alone
<input type="radio"/>	Active	Jeremy's NV8280	NV8280	192.168.102.152	Stand Alone
<input type="radio"/>	Standby	Kevin's NV8280	NV8280	192.168.102.155	Stand Alone
<input type="radio"/>	Active	Stu's NV8576 P	NV8576 Plus	192.168.102.190	Stand Alone
<input type="radio"/>	Standby	Expanded, Main

Refresh Summary | Open In New Window... | Save Status... | Print Status...

The upper region contains 6 'System Status' sections:

- Control Card Status.
- Peer Card Status. (The "peer" is the other control card, if present, in the frame).
- Frame Information.
- Alarms.
- Power Supplies.
- Fans.

Potential problems are highlighted in red text. *Not every potential problem is an actual problem.* For instance, if video reference 2 is missing, that is probably intentional, and is not necessarily a problem. It might be a problem if you expect a second video reference to be present.

If a system error message or power supply error message appears, consult your router's documentation or contact Miranda Technical Support.

(For troubleshooting card errors, see [Troubleshooting Module Type Errors](#) on page 67.)

The 'System Status' page is unique because you can open it in a separate window, so that you can view other MRC pages at the same time. To do so, click **Open in New Window** at the bottom of the page.

Open In New Window...

Status Panels

The 'Status Information' region has 6 panels that display router status, as follows:

Window	Description
Control Card Status	The state of the control card you have selected. Typically you would select the active control card of a router.
Peer Card Status	The state of the other control card in the frame, if it exists. If you chose the active control card for viewing, the "peer" is the stand-by card, and vice versa.
Frame Information	Router frame identification and video reference and overall IOXM card status. There is a section in this panel in which error messages for cards can appear. To view details about module error messages, click View Status Report in the 'Module Status' page. EE 1 stands for EEPROM. IOXM stands for "Input, Output, Xpt, Monitor" See Troubleshooting Module Status Errors on page 115.
Alarms	Lists all 7 system alarms. (If you have selected a standby control card, this information is not viewable.)
Power Supplies	The state of all power supply modules, both primary and redundant, installed in the router frame or in a separate power supply frame. (If you have selected a standby control card, this information is not viewable.)
Fans	All fans within the router frame and on the power supply modules, and the current state of each. (If you have selected a standby control card, this information is not viewable.)

How to View and Save System Status

- 1 Go to the 'System Status' page. From the **Control Cards** table at the bottom of the page, select a control card.
- 2 To save the status information to a file, click **Save Status** at the bottom of the page. A 'Save' dialog appears. In the 'Save' dialog, click **Browse** to specify the location and name of the file, and click **Save**.
- 3 To print the status, click **Print Status**. A 'Print' dialog appears. This dialog depends on your system and available printers. Use your normal methods to print.

Module Status Page

The 'Module Status' page lists all modules that are physically installed in a router frame, and indicates the state and "health" of each module. The module status page applies *only to NV8500 hybrid routers*, as evidenced by the 'Hybrid Routers' table at the bottom of the page.

Modules listed include "IOXM" cards: intput cards, output cards, xpt (crosspoint) cards, and monitor cards.

This is a sample page for a sparsely populated NV8576:

State of Individual Module

Module Class: **MADI INPUT**
 Module Status: **Card is healthy**
 Path Light: **ON**
 Rear Type: **Coax 9 Input**
 Temperature: **37c**
 Carrier Detect 1-9: **00000000**
 Video Port 01: **No Signal**
 Video Port 02: **HD - 720p59.94**
 Video Port 03: **No Signal**
 Video Port 04: **SD - 625i50**
 Video Port 05: **No Signal**
 Video Port 06: **SD - 625i50**
 Video Port 07: **No Signal**
 Video Port 08: **SD - 625i50**
 Video Port 09: **N/A**
 MADI In: **NOT PRESENT**

List of Modules

Location	Module	Status	Identify
Upper Input 01	NV8500 3Gig COAX 8 SDI / 1 TDM IN (EM0814)	●	●
Upper Input 05	NV8500 3Gig COAX 8 SDI / 1 TDM IN (EM0903)	●	●
Upper Input 14	NV8500 HD SDI 9 COAX IN (EM0783)	●	N/A
Lower Input 50	NV8500 AES ASYNC 9 IN (EM0687)	●	N/A
Upper Output 01	NV8500 3Gig COAX 16 SDI / 2 TDM OUT (EM0815)	●	N/A
Upper Output 03	NV8500 3Gig SDI EMB 16 COAX OUT (EM0815)	●	●
Upper Output 05	NV8500 AES ASYNC 18 OUT (EM0688)	●	●
Upper Output 07	NV8500 3Gig SDI EMB 16 COAX OUT (EM0815)	●	●
Upper Output 08	NV8500 3Gig SDI 18 COAX OUT (EM0785)	●	●

Network Frame Summary

Select	Online	Name	Type	IP Address	Expansion
<input type="radio"/>	● Active	Unicon3 MRK 133	NV8576 Plus	192.168.102.133	Expanded - Main
<input type="radio"/>	● Off-Line	Unicon3 MRK 143	NV8576 Plus	192.168.102.143	Expanded - Main
<input type="radio"/>	● Active	IOXM II 8280	NV8280	192.168.102.167	Stand Alone
<input type="radio"/>	● Active	LH NV8280_210	NV8280	192.168.102.210	Stand Alone
<input type="radio"/>	● Active	QA NV8144 Sec	NV8144	192.168.102.213	Stand Alone
<input type="radio"/>	● Off-Line	QA NV8144 Pri	NV8144	192.168.102.214	Stand Alone
<input type="radio"/>	● Active	*TS QA NV8576	NV8576	192.168.102.215	Stand Alone
<input type="radio"/>	● Active	Unicon3 MRK 222	NV8576 Plus	192.168.102.222	Expanded - Expansion
<input type="radio"/>	● Standby	Unicon3 MRK 223	NV8576 Plus	192.168.102.223	Expanded - Expansion

The page has 4 regions:

- Network frame summary (in which you can select a router frame).
- List of modules (in the selected router frame).
- Router graphic (front or back view of the selected router frame).
- Status of the selected module.

Network Frame Summary

At the bottom of the page is the 'Network Frame Summary' which has 3 tabbed tables. Use the 'Hybrid Routers' table to select a control card for the router for which you want to view module status. To select a control card, click the radio button in the 'Select' click the When you have selected

Click 'Refresh Summary' in the bottom region to ensure that the page is displaying the most current information:



Click 'View Status Report' to obtain more information about the status of the router frame:



The button has a red dot if there is information to view; otherwise the button is disabled.

Click 'View Change Report' to obtain more information about the module changes:



The button has a red dot if there is information to view; otherwise the button is disabled.

List of Modules

The list of modules includes all the "IOXM" cards (the input cards, output cards, xpt or crosspoint cards, and monitor cards in the router frame you selected.

Click anywhere in the list to select a module. The state of the module you select is displayed in the individual module status section.

Each row of the list of modules represents one module: These are the fields in each row:

Column	Description
Location	<p>The slot of the router frame in which the module is installed. The terms in this column depend on the router frame:</p> <p>Input <i>nn</i>— an input card in slot <i>nn</i>.</p> <p>Output <i>nn</i>— an output card in slot <i>nn</i>.</p> <p>Upper Input <i>nn</i> or Lower Input <i>nn</i>— (in the NV8576 and NV8576-Plus frames), an input card in slot <i>nn</i>, in the upper or lower bay, as indicated.</p> <p>Upper Output <i>nn</i> or Lower Output <i>nn</i>— (in the NV8576 and NV8576-Plus frames), an input card in slot <i>nn</i>, in the upper or lower bay, as indicated.</p> <p>Monitor— (in the NV8144 only) a monitor card.</p> <p>Input Monitor or Output Monitor— (in the NV8280 only) an input or output monitor card.</p> <p>Upper Input Monitor or Lower Input Monitor— (in the NV8576 and NV8576-Plus frames), an input monitor card in the upper or lower bay, as indicated.</p> <p>Upper Output Monitor or Lower Output Monitor— (in the NV8576 and NV8576-Plus frames), an output monitor card in the upper or lower bay, as indicated.</p> <p>Crosspoint <i>nn</i>— a crosspoint card.</p>
Modules	<p>The type of module installed. Module type is indicated by signal type and/or function. These are some of the terms in this column:</p> <p>DEM— disembedder (input) card</p> <p>FRAMESYNC— Frame sync input card</p> <p>EMB— embedder (output) card</p> <p>TDM— MADI input or output card</p> <p>STD— standard (i.e., non-hybrid) card</p> <p>HYBRID— hybrid card</p> <p>EXP— expansion card (for expanded frames)</p> <p>FILLER— expansion filler card</p>
Status	<p>The column contains circles that indicate the status of the modules:</p> <p>Green— the module is healthy, communicating with the control card, at the proper temperature, and has good power.</p> <p>Red— the module is “unhealthy” or in an alarm state. There are several causes of a red indicator. See IOXM Extended Status Data on page 148.</p>
Identify	<p>The column contains either circles that indicate the state of a module’s blue path light or “N/A” which means that the module has no path light.</p> <p>If the ‘Identify’ field has a circle, you can click the circle to turn on the path light of the module (in the frame). That way you can see, in the frame, the module you have identified in MRC.</p> <p>When the path light is on, the circle is blue; when it is off, the circle is gray:</p> 

(See [Module Types](#) on page 63.)

(See [Nomenclature](#) on page 25.)

If there is at least one red circle in the list of modules, one or both of the up and down buttons just above and to the right of the list of modules become active:



You can use these buttons—when they are active—to move to the next (or previous) faulty module and display its status and to navigate to the next or previous faulty module quickly. If these buttons are inactive, either there is no faulty module or there is exactly one faulty module and you have selected it.

Individual Module State

The information displayed in the individual module status fields varies greatly depending on the module and the signals actually connected to the module at the router backplane. (See [IOXM Extended Status Data](#) on page 148.)



This sample is typical of hybrid *disembedder* input cards:

The screenshot shows a 'Module Status' window with the following information:



Module Class:	HYBRID INPUT
Module Status:	Card is healthy
Path Light:	OFF
Rear Type:	Coax 9 Input
Temperature:	37c
Carrier Detect 1-9:	00000000
Video Port 01:	HD - 720p59.94
Video Port 02:	HD - 720p59.94
Video Port 03:	HD - 720p59.94
Video Port 04:	HD - 720p59.94
Video Port 05:	HD - 720p59.94
Video Port 06:	HD - 720p59.94
Video Port 07:	HD - 720p59.94
Video Port 08:	HD - 720p59.94
Video Port 09:	N/A

Below the table, there is a header for 'Input 15' with the description 'NV8500 3Gig SDI DEM 8 COAX IN (EM0814)'. To the right of this header are two status indicators: a green circle and a grey circle.



This sample is typical of hybrid *embedder* output cards:

Module Status			
Module Class: HYBRID OUTPUT			
Module Status: Card is healthy			
Path Light: OFF			
Rear Type: Coax 18 Output			
Temperature: 44c			
Output Lock 1-18: 000000000000000000			
Video Port 01: HD - 1080p59.94			
Video Port 02: HD - 1080p59.94			
Video Port 03: HD - 1080p59.94			
Video Port 04: HD - 1080p59.94			
Video Port 05: HD - 1080p59.94			
Video Port 06: HD - 1080p59.94			
Video Port 07: HD - 1080p59.94			
Video Port 08: HD - 1080p59.94			
Video Port 09: N/A			
Video Port 10: HD - 1080p59.94			
Video Port 11: HD - 1080p59.94			
Video Port 12: HD - 1080p59.94			
Video Port 13: HD - 1080p59.94			
Video Port 14: HD - 1080p59.94			
Video Port 15: HD - 1080p59.94			
Video Port 16: HD - 1080p59.94			
Video Port 17: HD - 1080p59.94			
Video Port 18: N/A			
Upper Output 03		NV8500 3Gig SDI EMB 16 COAX OUT (EM0815)	 

This sample is typical of *standard input* cards:

Module Status			
Module Class: STANDARD INPUT			
Module Status: Card is healthy			
Path Light: OFF			
Rear Type: Coax 9 Input			
Temperature: 34c			
Carrier Detect 1-9: 00000000			
Upper Input 11		NV8500 3Gig SDI 9 COAX IN (EM0783)	 

This sample is typical of *AES output* cards:

Module Status			
Module Class: AES OUTPUT			
Module Status: Card is healthy			
Path Light: OFF			
Rear Type: Coax 18 Output			
Temperature: 34c			
Upper Output 05		NV8500 AES ASYNC 18 OUT (EM0688)	 

This sample is typical of *hybrid crosspoint* cards:

Module Status

Module Class: HYBRID XPT
Module Status: Card is healthy
Path Light: OFF
Temperature 0: 39c
Temperature 1: 36c
Using TDM Link 1-16: 1100000000000000

Crosspoint 01 NV8500 144X144 3Gig XPT HYBRID (EM0819) ● ●

Graphic

A graphic representation of the router frame lets you see the exact location of an input, output, monitor, or crosspoint card in the frame. When you select a module, the row turns darker green, and the module is highlighted in yellow within the graphic:

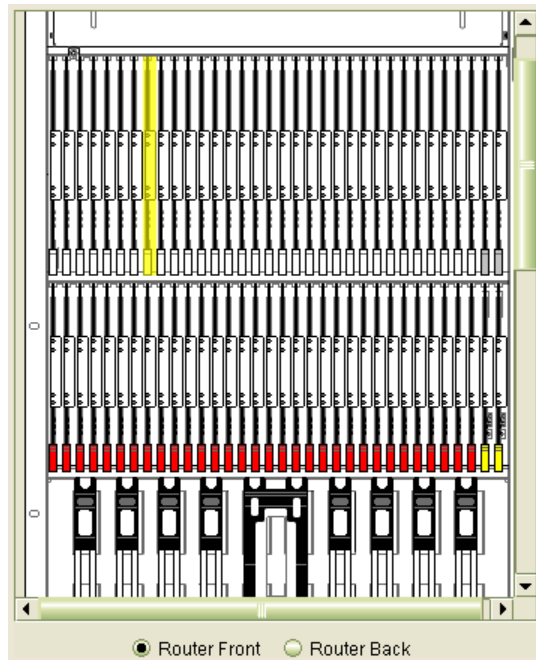

You might have to scroll the graphic to see the highlighted module.

Selecting Modules

You can select router modules in the 'List of Modules' section by clicking a row in that section. Selected rows (modules) are a darker green. Unselected rows are either white or light green.

You can select only one row at a time. The effect of selecting a row (an IOXM module) is (1) to highlight the module in the drawing and (2) to display status for the selected module.

You can also click any module in the drawing to select it. When you do so, the module is highlighted in yellow in the drawing and the module (if one is present in the slot) is highlighted in the input list.

Using the Module Status Page

The 'Module Status' page is view-only (and for NV8500 hybrid routers only). You cannot modify the data displayed on this page. But you can change the state of the path lights for certain modules.

The page does not provide information for control cards or power supply modules. You can use the 'System Status' to view the status of a control card or the router's power supplies.

Troubleshooting Module Status Errors

The 'Status' column in the list of modules provides instant module status: a green circle means healthy and a red circle means indicates that a problem exists. For more detailed information, you can make use of two report functions available through buttons at the bottom of the page:

- View Change Report



- View Status Report



A red dot on the button indicates that the status report contains error messages or warnings.

View Change Report

Clicking the 'View Change Report' button opens the 'Unexpected Module Change Errors' window, which lists error details whenever (1) a card is removed from the router frame, (2) a card is installed that does not match the card type configured for the slot, or (3) a card has been added to the frame.

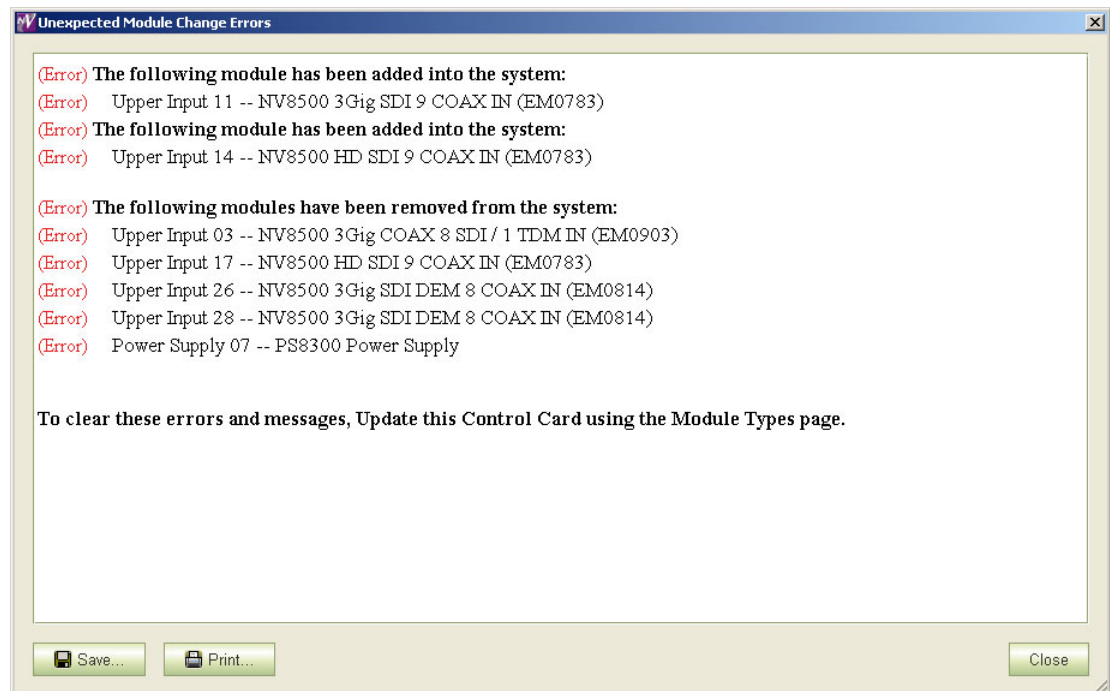

See [Troubleshooting Module Type Errors](#) on page 67.

View Status Report

Clicking the 'View Status Report' button opens the 'Module Status Report' that lists each module:



The screenshot shows a window titled "Module Status Report" with the following content:

Module Status Report
QA.NV8144 Sec at 192.168.102.213
1 Module is unhealthy

<u>Location</u>	<u>Module</u>	<u>Status</u>
Input 14	NV8500 3Gig COAX 8 SDI / 1 TDM IN (EM0814)	Card is healthy Extended Status : N/A
Input 15	NV8500 3Gig SDI DEM 8 COAX IN (EM0814)	Card is healthy Extended Status : N/A
Output 07	NV8500 3Gig COAX 16 SDI / 2 TDM OUT (EM0815)	Card is healthy Extended Status : N/A
(Error) Output 08	NV8500 3Gig SDI EMB 16 COAX OUT (EM0815)	Backplane does not match Extended Status : N/A

At the bottom of the window, there are three buttons: "Save...", "Print...", and "Close".

5 Network Setup

MRC communicates with routers through their control cards. Each control card (usually a primary and a secondary control card for redundancy) is configured identically but separately. The router can continue its operation uninterrupted while a control card is being updated. Each router control card must be part of the MRC network.

The 'Network Setup' section of the navigation pane includes two configuration pages.

- NVISION Series Products.
- Ethernet Settings.

The 'NVISION Series Products' page lists all devices (routers, compact routers, master control frames, master control panels, master control processors, NV9000 systems NV9000 control panels) detectable on the MRC network.

The 'Ethernet Settings' page lists control cards present in the MRC network. It allows you to modify their names and IP addresses.

Using these pages, you can perform the following tasks:

Task	Description	Related Topic
View a list of devices known to MRC	Use the 'NVISION Series Products' page.	NVISION Series Products Page on page 118
Peruse control cards of devices that MRC can configure.	Use the 'Ethernet Settings' page. (Colored icons (circles) indicate the state of the devices, including whether the device is a virtual device.	Ethernet Settings Page on page 119
Add control cards	Use the 'Ethernet Settings' page. Occasionally a control card is not automatically detected, such as when it is assigned to another subnet.	Adding and Removing Control Cards on page 122
Create "virtual" control cards	Use the 'Ethernet Settings' page. By creating a "virtual" control card, you can copy, configure, and save control card settings without having a physical device present. Later, copy virtual control card configurations to actual control cards.	Creating Virtual Control Cards on page 123
Lock configurations	Use any page. After settings are saved to a control card, the configuration can be locked. No changes can be made unless the card is unlocked.	Locking and Unlocking Configurations on page 126
Update IP addresses	Use the 'Ethernet Settings' page. Each control card must have a unique IP address. IP addresses can be updated at any time, as needed.	Updating an IP Address on page 127

This document assumes that you have a working knowledge of networks. If you are unsure about any network requirements, contact your system administrator. For an overview of networks, see [The MRC Network](#) on page 129.

Topics

<i>NVISION Series Products Page</i>	118
<i>Ethernet Settings Page</i>	119
<i>Adding and Removing Control Cards</i>	122
<i>Creating Virtual Control Cards</i>	123
<i>Locking and Unlocking Configurations</i>	126
<i>Updating an IP Address</i>	127

NVISION Series Products Page

The 'NVISION Series Products' page lists *all* devices in the MRC network. These devices are identified by their IP address. Each router has one or more control cards; each control card has an IP address. If devices on the network have duplicate IP addresses, the address(es) display in red and a warning appears at the bottom of the page.

Product Model	IP Address ▲	Product Family
NV9601	192.168.1.32	Router Control Panel
NV9602	192.168.1.33	Router Control Panel
NV9604	192.168.1.34	Router Control Panel
NV9642	192.168.1.35	Router Control Panel
NV9608	192.168.1.36	Router Control Panel
NV9609	192.168.1.39	Router Control Panel
NV9640	192.168.1.42	Router Control Panel
NV9640	192.168.1.43	Router Control Panel
NV9642	192.168.102.78	Router Control Panel
NV9000 Primary	192.168.102.88	Router Control
MC-FFCP	192.168.102.101	Master Control
iMC-Panel-100	192.168.102.102	Master Control
MC-CECP	192.168.102.115	Master Control
MC-FECP	192.168.102.116	Master Control
MC-CECP	192.168.102.117	Master Control
NV9000 Primary	192.168.102.119	Router Control
NV9642	192.168.102.119	Router Control Panel
MCPM-SD	192.168.102.121	Master Control
MCPM-MK-SD	192.168.102.122	Master Control
MCPM-SDHD	192.168.102.123	Master Control
MCE	192.168.102.124	Master Control
MCE	192.168.102.125	Master Control
MC-SCP	192.168.102.126	Master Control
* Unknown	192.168.102.133	Other NVISION Product
* NV8576 Plus	192.168.102.133	Large Router Family
NV8256 Plus	192.168.102.138	Large Router Family
* Unknown	192.168.102.143	Other NVISION Product
* NV8576 Plus	192.168.102.143	Large Router Family
MCE	192.168.102.145	Master Control
MCE	192.168.102.146	Master Control

Refresh List Network Interfaces... *Warning: Duplicate IP Addresses found.

You can correct IP addresses in the 'Ethernet Settings' page.

(See [Updating an IP Address](#) on page 127.)

The 'NVISION Series Products' page is information only. You cannot modify entries in this page.

In this page, NV9000 router control systems are noted as *Primary* or *Secondary*. A primary and a secondary system controller form a redundant pair. One controller in the pair is active; the other is stand-by.

Network Interfaces Button

Click the 'Network Interfaces' button at the bottom of the page to display a report of the network interface cards (NICs) in the configuration PC that you are using:

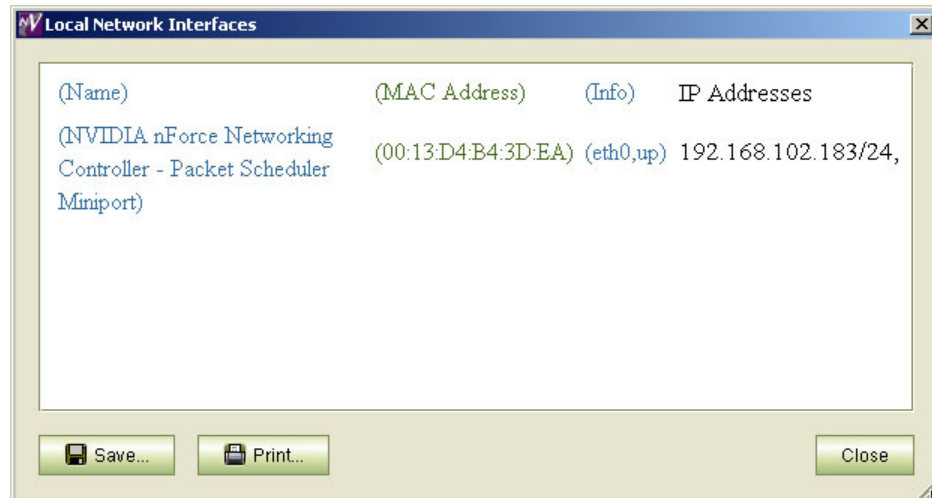

Ethernet Settings Page

The 'Ethernet Settings' table lists (1) router control cards and (2) NV8500 frame sync input cards in the MRC network and their associated Ethernet settings.

The table's 'Online' column displays the state of the table entries: (1) the "health" of the control card or frame sync input card, (2) whether a control card is "virtual" or physical, and (3) whether the control card's configuration is locked.

- ▲ A "virtual" control card is one that has an entry and a configuration in MRC, but corresponds to no physical control card. (A virtual control card needs no IP address.)

(See [Control Card State Indicators](#) on page 16.)

Physical control cards are identified by IP address. IP addresses must be unique. If any physical control card duplicates an IP address, MRC displays that address in red and gives a warning at the bottom of the page. It is in this page that you update IP addresses.

You can make changes simply by clicking a field in the table and editing the field. To execute an update, you must select control cards by checking the box in the 'Update' column and clicking the 'Update Settings' button at the bottom of the page.



Updates of the control cards are performed for the card you checked.

(See [Updating an IP Address](#) on page 127.)

Frame Sync Cards

Frame sync cards differ in treatment from router control cards.

When you place a frame sync card, with its backplane module, in a slot in a router frame, the card initially acquires a default IP address that is based on the slot number: the lower octet of the IP address is the slot number (in the range 1 to 64). The default subnet is 192.168.3.xxx.

You can — and should — assign specific IP addresses to all frame sync input cards.

After you establish (or at least learn) the IP addresses of frame sync cards in the 'Ethernet Settings' page, you can then configure their frame sync functions using Miranda's iControl-Solo software.

▲ Assigning IP addresses is especially important for the two frames of an expanded NV8576-Plus. The two frames have identical slot numbering. Using the defaults for IP address will probably result in duplicate IP addresses on the network you use to configure the cards. You must assign specific IP addresses to such cards.

▲ You can also access the frame sync card in a browser. The browser application (built into the frame sync card) lets you change the card's IP address or download a new configuration.

(See [Updating an IP Address](#) on page 127.)

Using the Page

Click 'Refresh List' at the bottom of the page, at any time, to ensure that you are viewing the most current information.

Ethernet Settings						
Update	Online	Name	Type	IP Address	Subnet Mask	Gateway IP
<input checked="" type="checkbox"/>	Virtual	NV5100 D	NV5100	0.0.0.0	0.0.0.0	
<input type="checkbox"/>	Active	Unicon3 MRK 133	NV8576	192.168.102.133	255.255.255.0	192.168.102.2
<input type="checkbox"/>	Active	Kevin's NV8280	NV8280	192.168.102.151	255.255.255.0	
<input type="checkbox"/>	Active	Stuarts +	NV8576 Plus	192.168.102.190	255.255.255.0	
<input type="checkbox"/>	Active	Stuarts +	NV8576 Plus	192.168.102.191	255.255.255.0	
<input type="checkbox"/>	Active	QA_8576+_	NV8576 Plus	192.168.102.210	255.255.255.0	
<input type="checkbox"/>	Active	QA_8576+_M	NV8576 Plus	192.168.102.211	255.255.255.0	
<input type="checkbox"/>	Standby	QA_8144	NV8144	192.168.102.212	255.255.255.0	
<input type="checkbox"/>	Active	QA_8144	NV8144	192.168.102.213	255.255.255.0	
<input type="checkbox"/>	Standby	QA_8576+_M	NV8576 Plus	192.168.102.214	255.255.255.0	
<input type="checkbox"/>	Active	Unicon3 MRK 222	NV8576	192.168.102.222	255.255.255.0	192.168.102.2
<input type="checkbox"/>	Standby	Unicon3 MRK 223	NV8576	192.168.102.223	255.255.255.0	192.168.102.2
<input type="checkbox"/>	Active	NV5128	NV5128	192.168.102.225	255.255.255.0	
<input type="checkbox"/>	Active	NV5128	NV5128	192.168.102.248	255.255.255.0	
<input type="checkbox"/>	Active	NV5128	NV5128	192.168.102.249	255.255.255.0	
<input type="checkbox"/>	On-Line	APCII, slot 2	Hybrid Input Frame Sync	192.168.102.148	255.255.255.0	192.168.102.240
<input type="checkbox"/>	On-Line	APCII, slot 4	Hybrid Input Frame Sync	192.168.102.191	255.255.255.0	192.168.102.240

Entries for Control Cards

These are the columns of the table as applicable to *control cards*:

Column	Description
Update	Check the check box to select the control card listed on that row and activate fields for updating. You must click 'Update Settings' at the bottom of the page to perform the update. Merely changing a field in the table does not cause an update.
Online	<p>The state of the control card.</p> <p>The word 'Active' means that the control card is active.</p> <p>The word 'Standby' means that the control card is standby.</p> <p>The word 'Virtual' means that the control card is a virtual control card.</p> <p>The color of the circle in this field shows the quality of MRC's communication with the control card:</p> <p>Green means good</p> <p>Yellow means that MRC can communicate with the card, but the card is "not healthy".</p> <p>Red means there is no communication (but MRC detects the card).</p> <p>Blue means that the control card is virtual.</p> <p>Grey means that the control card is offline and communication with MRC has ceased.</p> <p>A black lock icon indicates that the control card configuration is locked and cannot be changed until it is unlocked.</p> <p>See Locking and Unlocking Configurations on page 126.</p>
Name	A name you can assign to the router frame in which the control card is installed
Type	The router model (e.g., NV8576, NV5128)
IP Address	The IP address currently assigned to the control card
Subnet Mask	<p>The subnet mask currently assigned to the control card. It is recommended that you leave the subnet mask at 255.255.255.0.</p> <p>See The MRC Network on page 129.</p>
Gateway IP	Gateways are not used unless you are placing the router on a subnet different from the rest of your system. We recommend that you do not change gateway IP addresses unless you consult a system administrator.

The 'Online', 'Name', 'Type' and 'IP Address' information displayed in this page also appears on the 'Network Frame Summary' tabs viewable on most MRC pages. This illustration is from the 'Switch Points' page:

Video Routers		Network Levels		All Control Cards	
Edit	Online	Name	Type	IP Address ▲	Expansion
<input type="checkbox"/>	Virtual	NV5100 D	NV5100	0.0.0.0	Stand Alone
<input type="checkbox"/>	Active	Unicon3 MRK 133	NV8576	192.168.102.133	Stand Alone
<input type="checkbox"/>	Active	Kevin's NV8280	NV8280	192.168.102.151	Stand Alone
<input type="checkbox"/>	Active	Stuarts + Main	NV8576 Plus	192.168.102.190	Expanded - Main
<input type="checkbox"/>	Active	Stuarts + Exp	NV8576 Plus	192.168.102.191	Expanded - Expansion
<input type="checkbox"/>	Active	QA_8576+_E	NV8576 Plus	192.168.102.210	Expanded - Expansion
<input type="checkbox"/>	Active	QA_8576+_M	NV8576 Plus	192.168.102.211	Expanded - Main
<input type="checkbox"/>	Standby	QA_8144	NV8144	192.168.102.212	Stand Alone
<input type="checkbox"/>	Active	QA_8144	NV8144	192.168.102.213	Stand Alone

Entries for Frame Sync Cards

These are the columns of the table as applicable to *frame sync input cards*:

Column	Description
Update	Check the check box to select the frame sync card listed on that row and activate fields for updating. You must click 'Update Settings' at the bottom of the page to perform the update. Merely changing a field in the table does not cause an update.
Online	The state of the frame sync card. The word 'Online' means that the frame sync card is available. The word 'Offline' means that the frame sync card is not available. The color of the circle in this field shows the quality of MRC's communication with the control card: Green means good. Yellow means that MRC can communicate with the card, but the card is "not healthy". Red means there is no communication (but MRC detects the card). Grey means that the frame sync card is offline and communication with MRC has ceased.
Name	A name you can assign to the frame sync card.
Type	The type (at present) is "Hybrid Input Frame Sync."
IP Address	The IP address currently assigned to the frame sync card (for the sake of configuring its frame sync functions).
Subnet Mask	The subnet mask currently assigned to the frame sync card. It is recommended that you leave the subnet mask at 255.255.255.0. See The MRC Network on page 129.
Gateway IP	Gateways are not used unless you are placing the frame sync card on a subnet different from the rest of your system. We recommend that you do not change gateway IP addresses unless you consult a system administrator.

Adding and Removing Control Cards

Adding Control Cards

MRC detects most control cards on its network automatically. These appear automatically in the 'Ethernet Settings' page. However, if a control card is on a different subnet, it is not detectable, and you must add it to the Ethernet settings list manually. Use the 'Add Device' button:



In this page, virtual control cards must also be added to the list manually.

Removing Control Cards

When automatically detected control cards are removed from the network, they are also automatically removed from the 'Ethernet Settings' page. You might need to click 'Refresh List' at the bottom of the page to see those network changes.

Manually added cards, including virtual control cards, can be removed with the 'Remove Device' button:



You cannot remove control cards from the list that are automatically detected.

Removing an added control card from the Ethernet settings list does not affect the actual control card. Removing a virtual control card from the list does not affect its saved configuration file (if you created one).

How to Add a Physical Control Card (Manually)

- 1 Verify that the router housing the control cards you will be adding is connected to an Ethernet subnet accessible to your PC running MRC. If you are unsure of the network connections, contact your System Administrator.
- 2 Go to the 'Ethernet Settings' page. Click **Add Device**. The 'Add Device' dialog appears.
- 3 Choose the 'Add a Manual IP' radio button and enter the control card's IP address in the field provided.

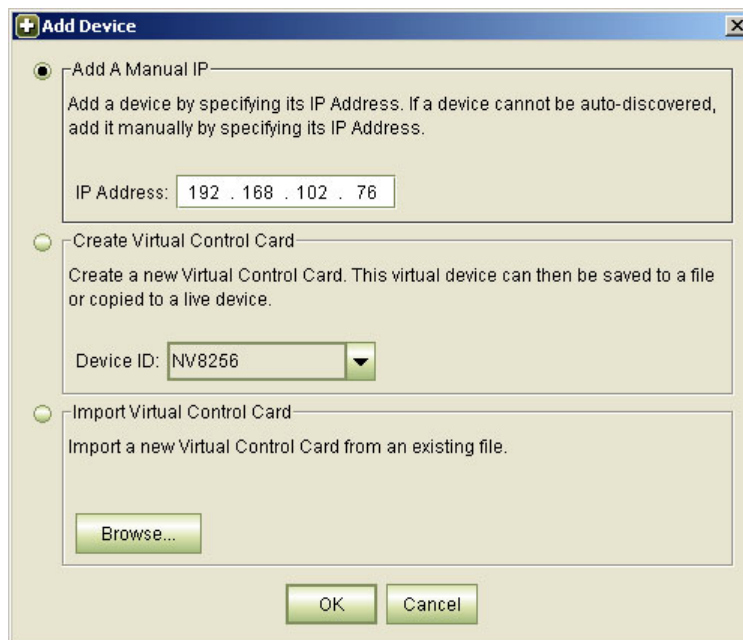

- 4 Click **OK**.
- 5 Each control card must be added separately and must have a unique IP address. Repeat this procedure for each control card in the added router.

Creating Virtual Control Cards

"Virtual" control cards allow you to configure and save control card settings without having a physical control card present. After a virtual control card has been created, its configuration can be modified at will and subsequently copied to a physical control card.

Virtual control cards can be created in 3 ways:

- A *blank* virtual control card is created using the 'Ethernet Settings' page. See [How to Create a Blank Virtual Control Card](#) on page 124.
- A *pre-configured* virtual control card is created by copying existing control card settings from a new virtual control card.

See [Copy Settings Page](#) on page 69.

- A *pre-configured* virtual control card is created by importing control card settings from a saved configuration file (a .zip file).

See [How to Create a Virtual Control Card by Importing a Configuration File](#) on page 125.

MRC treats virtual control cards the same way it treats physical control cards.

MRC denotes virtual control cards by a blue circle in many of its tables.

Virtual control cards have no IP address. (The IP address field appears as 0.0.0.0 in the tables.)

How to Create a Blank Virtual Control Card

- 1 Go to the 'Ethernet Settings' page. Click **Add Device**. The 'Add Device' dialog appears.

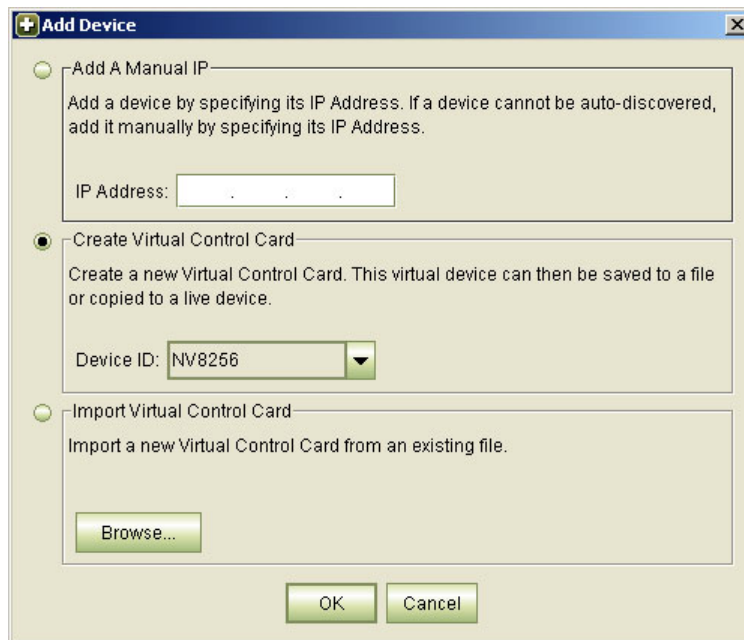

- 2 Choose the **Create Virtual Control Card** radio button and then select a device type from the **Device ID** drop-down menu. Devices are listed by model number, such as EC9535, NV5100, or NV8576 hybrid. The virtual control card will contain a configuration for that device type.
- 3 Click **OK**. The new virtual control card appears in the 'Ethernet Settings' page, denoted by a blue circle and the word 'Virtual'.

How to Create a Virtual Control Card by Importing a Configuration File

- 1 Go to the 'Ethernet Settings' page. Click **Add Device**. The 'Add Device' dialog appears.

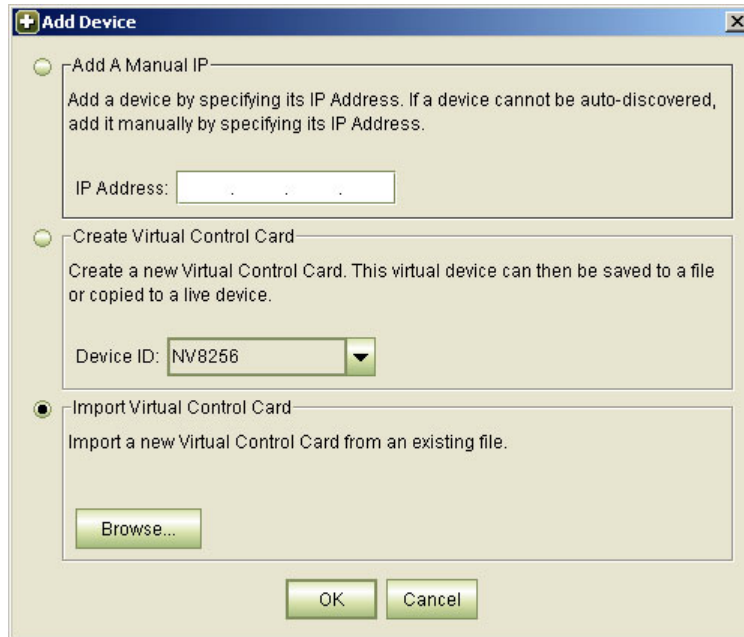

- 2 Choose the **Import Virtual Control Card** radio button. Click **Browse . . .** to navigate to your virtual control card file and select it. Virtual cards have a.zip file extension.
- 3 Click **Open**. The new virtual control card appears in the 'Ethernet Settings' page, denoted by a blue circle and the word 'Virtual'!

How to Remove an Added Physical or Virtual Control Card

- 1 Go to the 'Ethernet Settings' page. Check the check box in the **Update** column on the row representing the control card you want to remove. The 'Remove Device' button becomes enabled (if it wasn't already enabled).
- 2 Click **Remove Device**.
The button can remove only manually added control cards or virtual control cards.
- 3 Click **OK** in the confirmation window that appears.

Locking and Unlocking Configurations

After a control card is configured, you might want to lock the configuration to prevent any unwanted changes. Locked control cards can be unlocked at any time.

Locking a control card configuration does not lock its crosspoints.

Locks can also be applied through the 'Unlocked Warning' message that appears whenever MRC is closed or through the context menu that appears on the **Control Cards** tables throughout MRC.

How to Apply Locks when Closing MRC

- 1 Whenever you exit MRC and there are unlocked control cards, the 'Unlocked Warning' message appears, listing all unlocked configurations.



- 2 Either select the control cards you want to lock. There are 'Select All' and 'Select None' buttons as shortcuts. . . .

Click 'Lock Selected Cards and Exit'. MRC locks the control cards and exits.

You can also click 'Return to MRC' if you do not want to exit.

- 3 Or, dismiss the warning by clicking the X at the top right.

To Apply a Lock from a Control Cards Table

- 1 Go to any MRC page that has a **Control Cards** table in the 'Network Frame Summary' section. From the table, select a control card.
- 2 Right-click on the control card to display a context menu.



Check its 'Configuration Locked' check box or simply click 'Configuration Locked'.

- 3 A 'Lock Configuration Settings' message appears. Click **Yes** to proceed.

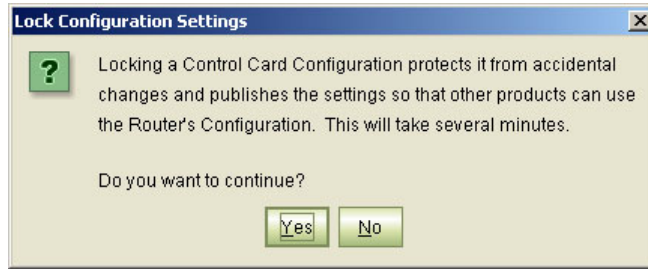

- 4 Click **OK** in the confirmation window. When the lock is complete, a black lock icon appears next to the control card wherever the card is listed in MRC.

To Unlock a Control Card

- 1 Go to any MRC page that has a **Control Cards** table in the 'Network Frame Summary' section. From the table, select a control card to unlock. Locked control cards show a black lock icon.
- 2 Click **Yes** in the 'Unlock Configuration Settings' window.
- 3 Click **OK** in the confirmation window. (The lock icon is removed.)

Updating an IP Address

You can modify the Ethernet settings assigned to a control card or an NV8500 frame sync card at any time.

It is important that any updated IP addresses be communicated to the persons who configure the router control system, its control panels, frame sync cards, and other devices, so that communication between those devices is not interrupted. For more information, contact your system administrator.

Virtual control cards have no IP address.

IMPORTANT

Each control card in a router must be configured separately and identically.

Note also that subnet 192.168.101.xxx is reserved by the router for internal use.

To Update One or More IP Addresses

- 1 Go to the 'Ethernet Settings' page.
- 2 Locate the control card or frame sync card you want to update.
- 3 Click in its 'IP Address', 'Subnet Mask', or 'Gateway IP' fields to edit those field.
Type in the new values, as needed. Be careful that each IP address is unique. The default subnet is 192.168.1.xxx.
We recommend that you leave the subnet masks at 255.255.255.0 unless otherwise directed. (See [The MRC Network](#) on page 129.)
Press <enter>, <tab>, or click in another area of the table to complete the entries.
- 4 Repeat step 2 and 3 for other control cards and frame sync cards you want to modify.
A row's **Update** check box is automatically checked if you change any information in that row.

- 5 Finally, click **Update Settings** to write the changes to the selected control cards and frame sync cards. Only those cards having check marks are updated.

6 Tutorials

This section provides background information on various routing and network topics. This information is general in nature and not meant to describe specific situations.

Most of this material is elementary and well-known to broadcast facility personnel.

Topics

The MRC Network	129
Routing	131
Signal Types	133
Levels	134
Mono and Stereo Switching	135
Video Fields and Frames	135
Redundant and Dual Video References	139
Switching "Rules"	139
Embedded Group Control	141
Pass-Through Sources	142
IOXM Extended Status Data	148

The MRC Network

MRC communicates with router control cards and router control systems through an Ethernet network. The different devices on the network are identified by their IP addresses. The network includes one or more computers on which MRC is installed and an Ethernet switch capable of 100 MB/s operation with enough ports to accommodate the PC running MRC and the routers MRC is configuring. The simplest MRC network uses a single Ethernet switch, a single subnet, and a variety of routers and configuration computers connected at the switch:

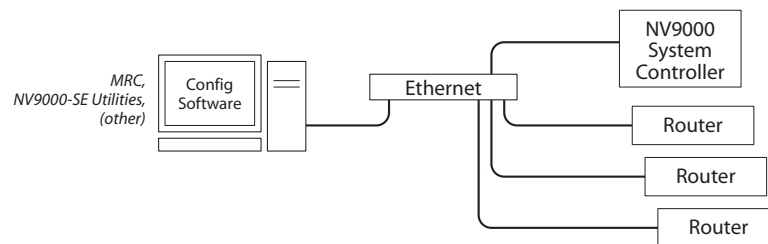

Each control card, including any secondary (or redundant) control cards, must have a unique IP address for the network to function correctly.

MRC notifies you of any duplicated IP addresses and the router control cards and other devices that are consequently inaccessible on a specific subnet.

What is an IP Address?

An IP address¹ is a 32-bit number denoted by four 8-bit values (octets) separated by periods: 192.168.1.87, for example. Usually, the first three octets form a *subnet* and the last octet is a unique device identifier, within the bounds of the subnet. Each octet can have a value from 1 to 254. (The values 0 and 255 are *reserved* for other purposes.)

(See [What is a Subnet?](#) on page 130.)

For example, if a device's IP address is 192.168.1.87, the router's subnet is 192.168.1 and its unique device identifier is 87.

In addition to IP addresses, many networks support the use of plain-language (English, Spanish, etc.) names for devices on the network. These are usually managed by a name server using DNS (Dynamic Name Service), WINS (Windows Integrated Name Service), or similar.

Miranda routers and MRC do *not* support plain text naming. The router network should be a closed, private network.

Unless otherwise specified by your system administrator, Miranda suggests the following IP address settings for their routers' control cards:

Router Number	Primary Control Card	Secondary Control Card
1	192.168.1.5	192.168.1.6
2	192.168.1.7	192.168.1.8
3	192.168.1.9	192.168.1.10
4	192.168.1.11	192.168.1.12
...		

The configuration PC should be set to the following IP address: 192.168.1.19. If you specify a different subnet, use a unique address on the same subnet that the routers use.

If your configuration PC is already connected to a network, it might be impractical or undesirable to change its IP address. If this is your situation, we recommend installing a second network card in your PC that is connected to the routers' subnet. Doing so preserves your existing network settings and allows you to create a fixed IP address, and any other required network settings, for routers.

Consult your system administrator before adding a NIC (network interface card) to any PC already set up with a network connection. The new NIC may interfere with Windows bindings or other network settings if it is not added correctly.

You can use the 'Network Interfaces' button of MRC's 'NVISION Series Products' page to obtain a report of the NICs in your configuration PC.

What is a Subnet?

A subnet is an identifiable and distinct part of a network that allows a large network to be organized into smaller sections. For example, a subnet may represent all the machines at one geographic location or on the same local area network (LAN).

1. IPv4.

Devices that reside on the same subnet may communicate with each other. For devices to communicate on a network, they must reside on the same subnet.

The subnet is determined by a *subnet mask*.

What is a Subnet Mask?

The subnet mask is a 32-bit mask that determines how many bits of an IP address are used for the subnet and how many bits are used for device identifiers.

Generally, the left-most 24 bits are used for the subnet and the right-most 8 bits are used for a device identifier. Thus, the typical subnet mask is represented by 255.255.255.0. (The value 255 is the decimal value of eight "1" bits.)

A subnet mask does not need to be 24 bits. A mask of 22 bits (255.255.252.0) allows 4 times as many devices on the subnet. Most NVISION equipment defaults to 24-bit subnet masks.

What is a Gateway IP Address?

A gateway is a network router that allows two subnets to communicate. A gateway IP address identifies the gateway, allowing a device to communicate with the other subnet.

Cabling

Use Category 5 Ethernet cable for all Ethernet connections. (Ethernet connectors are RJ-45.)

Some router connections (particularly for automation) require serial cables. These connectors are DE-9, female.)

Using Switches

When several devices must be interconnected, a network switch is required. Switches transmit data from any one port to all other ports, and receive data from any port. All Miranda products support communication at 100Mb/s. When you are selecting a switch, make sure it works at this speed. It will need one port for every device you intend to connect.

Note: when you are connecting only two devices (for example, the configuration PC and a single router control card), you can use an Ethernet crossover cable between the PC and the control card. A switch is not required.

Routing

Routing is the connection of (output) signals from one device to the input(s) of another device through another device (the router) under software control. The term *device* represents a broad range: cameras, video recorders, satellite feeds, monitors, meters, up/down converters, distribution amplifiers, and so on.

The term *device*, in the context of NV9000-SE Utilities, is defined as a set of related router inputs and outputs, possibly spanning multiple routers of different types. The inputs and outputs in the set are usually connected to a single physical device.

It is possible, and sometimes desirable, to define multiple devices that use the same ports. You might do this to be able to treat audio input or output as stereo at times and as mono at other times.

Each of the individual inputs and outputs of a device is assigned to a distinct *level*. A router can be partitioned into physical levels, in different ways, depending on the router. Some routers switch both video and audio signals. Such routers might have two physical levels, one for video and one for audio.

NV9000-SE Utilities defines “virtual” levels. A virtual level is an abstraction that corresponds to a signal type occurring in many different physical devices. (MRC does not deal with virtual levels, only physical levels.)

A *source* device is one that send signals to a router (or routers). A *destination* device is one that receives signals from a router or (routers).

We say that destinations are *sets of outputs*. But we also remember that physical destination devices have inputs connected to those outputs!

Similarly, sources are *sets of inputs*, and we remember that physical source devices have out-puts connected to those inputs!

Usually routers manage hundreds or thousands of incoming and outgoing signals.

To manipulate the incoming and outgoing signals—how they are switched in the router—operators use control panels. Commands from the control panels are sent to the routers telling the routers how to switch the signals. Status from the routers is returned to the control panels.

What is a Router?

Suppose you have two VCRs and one TV. You want to be able to view a movie from either VCR. So you plug the cable from one VCR into the TV. When you want to use the other VCR, you have to change cables. After a while, that gets a little tiresome. Wouldn't it be easier if you had a switch you could flip?

Now suppose you have a dozen TVs and a dozen VCRs plus cable service. You want to be able to direct any program from any VCR or from the cable company to any of the TVs.

That is what routers do: direct the content from a number of inputs to selected outputs.

A router is a device that switches (i.e., routes) incoming signals to different outputs under software control. A router usually has a substantial number of inputs and outputs, and uses a crosspoint matrix to perform the switching.

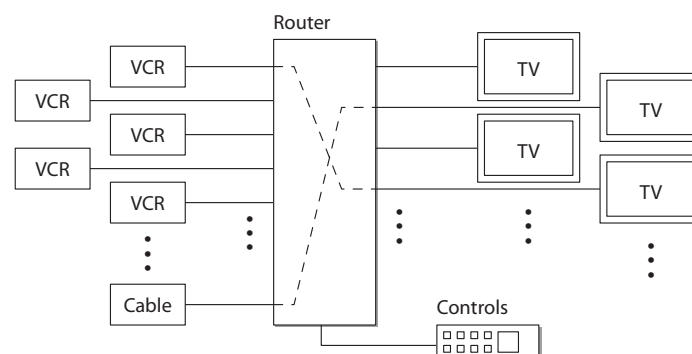

In the crosspoint matrix, any input can be connected to any or all outputs. However, no output can be connected to more than one input because routers do not *mix* input signals.

If you have DVD players, it is slightly more complicated: there are several signals for each DVD and you will need a router for each of the different signal types. Further, you might need converters if your TVs are older models that cannot receive DVD input.

Routers (and control panels) allow you to control and route signals to and from your equipment. Routers and control panels do *not* start, stop, rewind, cue, or fast-forward any device.

The Crosspoint Matrix Inside the Router

In concept, at least, a router contains an array of wires. (Physically, it might be different.)

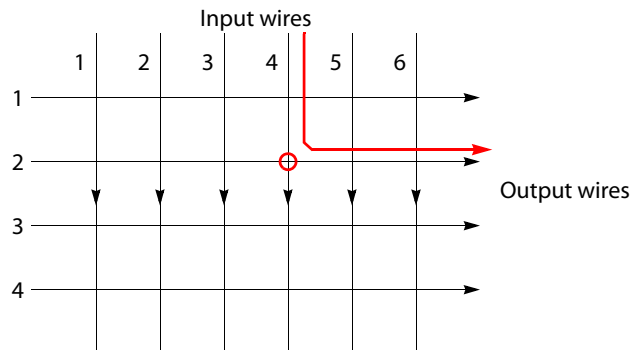

Fig. 6-1: A rudimentary switching matrix

If you had the patience and some materials, you could build a simple router. It would be nothing more than a number of wires arranged so they cross over each other. If you pressed two wires together where they cross, a signal could flow (given proper electrical connections) from the input to the output. In Figure 6-1, input wire 4 and output wire 2 are connected.

The point where they cross is called a *crosspoint*. The pattern formed by all the points is called a *crosspoint matrix*.

If a matrix has N inputs and M outputs, it has $N \times M$ crosspoints. The 6x4 matrix depicted above has 24 crosspoints. By convention, the number at the left of the \times represents inputs; the number on the right, outputs.

In a real router, the matrix is an integrated circuit, and the connection between an input and an output is performed electronically (by a transistor or similar circuit).

Some routers also perform signal conditioning at the inputs and outputs of the matrix.

Sources and Destinations

The signals that routers process come from, and go to, *devices*. "Device" is a generic name for VCRs, DVDs, cameras, video monitors, audio monitors, mixers, video editing workstations, and so on.

A *source* device is one that feeds a signal into a router. The *source* is where the signal originates.

A *destination* device is one that receives a signal from a router. The *destination* is where the signal is going.

Signal Types

Video signals are classified as digital (3Gig, HD, SD) or analog. Audio signals are classified as digital or analog and in addition, as stereo or mono. For most NVISION series routers, digital

audio is AES3id (AES for short). There are several different digital video formats and two analog video formats. Video signals might or might not also carry audio signals. Audio carried in a digital video signal is called *embedded* audio. Digital video can embed (carry) up to 16 individual AES audio channels.

Analog signals are not directly compatible with digital signals, but devices that convert one to the other are available.

The different digital formats are also not compatible, but Miranda's HD routers can also route SD signals and its 3Gig routers can also route HD and SD signals. Some video monitors recognize several different formats and adjust to display the format they receive.

AES signals are usually numbered as stereo pairs.

Available Signal Types

MRC supports a wide range of signal types. But, for any router type, only certain signal types can be configured. Only those signal types that can be switched by the router appear in MRC's 'Router Levels' page during configuration.

You can also select crosspoint matrices, by signal type, in the 'Crosspoints' page.

The fundamental signal types are AES, timecode, digital video, analog video, analog audio, and machine control.

The fundamental signal types have been mapped into several physical level types, whose names are listed here:²

Video, Async AES, Timecode	HD Digital Video
Sync AES Stereo, Analog Audio	SD Digital Video
Sync AES Mono, Analog Audio	Machine Control Reverse
Asynchronous AES	Machine Control Broadcast
Analog Audio or Timecode	Machine Control Forward
Analog Video or Timecode	Output Follow
3Gig, HD or SD Digital Video	Data X/Y Switching
Synchronous Audio	Monitor
Digital Video	Analog Audio
Synchronous Stereo Audio	

The meaning of these physical level aggregates can be found in the documentation for the router you are configuring.

Levels

Physical levels are partitions used to organize switching within a router. Certain routers (such as the NV5128 or NV8576) can switch signals of different types. A router switches signals within a level, never between levels. Inputs can be routed to outputs only in the same level.

A level can encompass either a portion of a switching matrix or the entire switching matrix. Levels may overlap.

2. "Audio Follows Video" was a physical level choice for NV8500 hybrid routers. It is no longer available because its functions have been made available through other means. It is possible that some routers in the field still have this physical level type.

A router must have at least one level defined. If no level is defined, the router's control card will be in an error state (red LED illuminated).

Mono and Stereo Switching

Mono and Stereo in the NV8500 Hybrid Routers

The NV8500 series routers supports two forms of audio:

- Asynchronous AES. This is discrete AES available through the router's AES input and output cards.
- Synchronous AES. This is AES embedded in standard video and hybrid video I/O and multiplexed in MADI I/O.

Asynchronous AES is always stereo and is switched the same way that video signals are switched.

Synchronous AES is always mono and can be recombined in any way as long as the router has disembedder and embedder cards or MADI cards. If you want to create stereo pairs, it is a simple matter to create devices in NV9000-SE Utilities that have two mono levels.

Mono and Stereo in Other Routers

Caution: although MRC can open, save, and upload configurations for routers other than NV8500 hybrid routers, it does not *officially* support any routers other than NV8500 hybrid routers.

UniConfig must be used for a successful configuration of routers other than the NV8500 hybrid routers.

Mono audio partitions in the NV7256, NV7512 and NV5128 are a case in point. At this time, MRC does not properly configure mono audio partitions.

Video Fields and Frames

For interlaced video, a frame comprises two *fields*, field 1 and field 2. Progressive video does not have fields.

For NTSC interlaced video, there are 30 frames (60 fields) per second. For NTSC progressive video, there are 60 frames per second.³

Note: If you are configuring an NV8256 or NV8256-Plus, MRC's 'Output Attributes' page lets you configure outputs to switch on a frame or a field basis.

About Vertical Timing

A "switch point" is a point in time in which an output is switched from its current source to a new input. Different video and audio formats require different switch points to prevent switching artifacts (noise or disturbances).

SMPTE standards specify the video lines where the switch should occur. The line number and position within the video line vary by signal format and line rate. A router's control card uses the

router's externally supplied reference signal(s) and the appropriate switch point (for SD or HD) to determine when the switch occurs and then initiates the switch.

The signals being switched must be (vertically) timed to its reference signal. In other words, both the reference signal and the signal being switched must have matching vertical timing.

Video reference are received through two connectors on the router frame labeled 'Video Ref' or 'Video Ref 1' and 'Video Ref 2'. When both video reference connections use the same type of signal, we call it "redundant" reference. When the reference connectors use two different signals, we call it "dual" reference.

(See [Redundant and Dual Video References](#) on page 139.)

For details on video reference connections, see the router *User's Guide*.

SMPTE Standards for Switch Point

SMPTE standards define the switch point. For NVISION series routers, the following signal types may be connected to the video reference connections on the router:

NTSC	720p/60 Tri-level
PAL	1080i/50 Tri-level
1080i/59.94 Tri-level	1080p/50 Tri-level
1080p/59.94 Tri-level	720p/50 Tri-level
720p/59.94 Tri-level	1080p/24 Tri-level
1080i/60 Tri-level	1080p/23.97 Tri-level
1080p/60 Tri-level	

Tri-level signals are nominally 600mVpp when terminated in 75Ω. The router will switch properly if tri-level is double terminated, as well. The router will not work when a tri-level input is not terminated.

External References and Switch Point Configurations

The following are possible sets of external references and switch point configurations:

- NTSC Reference, Software configures HD switch for 1080i
 - SD 525/59.94 will switch correctly.
 - HD 1080i/59.94 will switch correctly.
 - HD 720p/59.94 will switch, but not at the correct time.
 - HD 1080p/59.94 will switch, but not at the correct time.
 - All other standards will switch, but not switch at the correct time.
- NTSC Reference, Software configures HD switch for 1080p
 - SD 525/59.94 will switch correctly.
 - HD 1080p/59.94 will switch correctly.
 - HD 1080i/59.94 will switch, but not at the correct time.
 - HD 720p/59.94 will switch, but not at the correct time.
 - All other standards will switch, but not at the correct time.

3. Actually, 59.94 and 29.97 frames per second.

- NTSC Reference, Software configures HD switch for 720p
SD 525/59.94 will switch correctly.
HD 720p/59.94 will switch correctly.
HD 1080i/59.94 will not switch at the correct time.
HD 1080p/59.94 will switch, but not at the correct time.
All other standards will switch, but not at the correct time.
- PAL Reference, Software configures HD switch for 1080i
SD 625/50 will switch correctly.
HD 1080i/50 will switch correctly.
HD 1080p/50 will switch, but not at the correct time.
HD 720p/50 will switch, but not at the correct time.
All other standards will switch, but not at the correct time.
- PAL Reference, Software configures HD switch for 1080p
SD 625/50 will switch correctly.
HD 1080p/50 will switch correctly.
HD 1080i/50 will switch, but not at the correct time.
HD 720p/50 will switch, but not at the correct time.
All other standards will switch, but not at the correct time.
- PAL Reference, Software configures HD switch for 720p
SD 625/50 will switch correctly.
HD 720p/50 will switch correctly.
HD 1080i/50 will switch, but not at the correct time.
HD 1080p/50 will switch, but not at the correct time.
All other standards will not switch at the correct time.
- 1080i/59.94 Tri-Level Reference (no software configuration)
SD 525/59.94 will switch correctly
HD 1080i/59.94 will switch correctly.
HD 720p/59.94 will switch, but not at the correct time.
HD 1080p/59.94 will switch, but not at the correct time.
All other standards will switch, but not at the correct time.
- 1080p/59.94 Tri-Level Reference (no software configuration)
SD 525/59.94 will switch, but *not* correctly.

In summary, the switch points for the odd and even fields of SD are not the same time from the start of a 1080p frame. There is a 50% chance the switch will occur at the correct point in time.
HD 1080p/59.94 will switch correctly.
HD 720p/59.94 will switch, but not at the correct time.
HD 1080i/59.94 will switch, but not at the correct time.
All other standards will switch, but not at the correct time.

- 720p/59.94 Tri-Level Reference (no software configuration)

SD 525/59.94 will switch, but **not** correctly.

In summary, the switch points for the odd and even fields of SD are not the same time relative to the start of a 720p frame. There is a 50% chance the switch will occur at the correct point in time. The other 50% chance is that the switch will occur about 2/3 of a line early.

HD 720p/59.94 will switch correctly.

HD 1080p/59.94 will switch, but not at the correct time.

HD 1080i/59.94 will switch, but not at the correct time.

All other standards will switch, but not at the correct time.

- 1080i/50 Tri-Level Reference (no software configuration)

SD 625/50 will switch correctly.

HD 1080i/50 will switch correctly.

HD 1080p/50 will switch, but not at the correct time.

HD 720p/50 will switch, but not at the correct time.

All other standards will switch, but not at the correct time.

- 1080p/50 Tri-Level Reference (no software configuration)

SD 625/50 will switch, but **not** correctly.

In summary, the switch points for the odd and even fields of SD are not the same time relative to the start of a 720p frame. There is a 50% chance the switch will occur at the correct point in time.

HD 1080p/50 will switch correctly.

HD 1080i/50 will switch, but not at the correct time.

HD 720p/50 will switch, but not at the correct time.

All other standards will switch, but not at the correct time.

- 720p/50 Tri-Level Reference (no software configuration)

SD 625/50 will switch, but NOT correctly.

In summary, the switch points for the odd and even fields of SD are not the same time relative to the start of a 720p frame. There is a 50% chance the switch will occur at the correct point in time. The other 50% chance is that the switch will occur about 2/3 of a line early.

HD 720p/50 will switch correctly.

HD 1080p/50 will switch, but not at the correct time

HD 1080i/50 will switch, but not at the correct time

All other standards will switch, but not at the correct time.

- 1080p/24 Tri-Level Reference (no software configuration)

All SD formats will switch, but not at the correct time.

There are no SD formats that frame-align with a 24Hz frame reference, so it is impossible to guarantee an SD signal will switch at the correct point in time.

HD 1080p/24 will switch correctly.

All other HD standards will switch, but not at the correct time.

- 1080p/23.97 Tri-Level Reference (no software configuration)

All SD formats will switch, but not at the correct time.

There are no SD formats that frame-align with a 23.97Hz frame reference, so it is impossible to guarantee an SD signal will switch at the correct point in time.

HD 1080p/23.97 will switch correctly.

All other HD standards will switch, but not at the correct time.

Redundant and Dual Video References

Each router has two video reference connectors. The same reference can be used at both connectors or a different reference can be applied at each connector. When you are using the same (or “redundant”) reference, if one reference fails, the control card automatically fails over to the redundant reference.

You can select “redundant” or “dual” reference, globally, in the ‘Output Attributes’ page. (See [Output Attributes Page](#) on page 50.)

Switching “Rules”

There are presently 5 aspects involved in what are called “switching rules.”

- Embedded group control (and “null” audio).
- Pass-through audio.
- Obsolete ‘AFV’ partition.
- Input attribute — force embedder on.
- Tally — effective status versus actual status.

Null Audio

By the creation and use of “null” audio sources, operators can control whether embedded audio channels are null. Individually, null channels carry silence. When all 4 channels in an audio group are null, the output embedder does not emit the group in the output.

See [Embedded Group Control](#) on page 141 for more information.

Pass-Through Audio

By the creation and use of a “pass-through” source, operators can route the embedded audio from a standard video input to a hybrid (disembedder/embedder) output directly and with little effort.

▲ This capability has existed, but with limitations. “Pass-through” eliminates the limitations.

See [Pass-Through Sources](#) on page 142 for more information.

AFV Partition

The routers’ switching rules accommodate ‘AFV’ partitions, but AFV partitions are not supported by recent releases of MRC.

▲ If your router has an AFV partition and you want to continue to use it, do not delete it. You cannot recreate it in the newer versions of MRC.

Force Embedder On

MRC allows you to specify a "force embedder on" attribute for any and all inputs. When the attribute is off, the output embedder obeys general switching rules. When the attribute is on, the embedder is forced on, regardless of other factors.

▲ Embedders on disembedder/embedder output cards are always on.

Tally

There are two forms of tally: "effective" status and actual status.

"Effective status" applies to standard input cards. Audio sources from standard input cards are tallied as if they were from a disembedding input card.

"Actual status" applies to disembedder cards or MADI input cards. Here, audio tally consists of actual audio sources.

Understanding How the Rules Combine

The rules are complex and mutually contradictory. The easiest way to understand how the rules work is to follow the algorithm that implements the rules. This algorithm to determine whether to bypass the embedder is portrayed in simple terms here.

```
IF video matrix take
  Set video source
  IF level is AFV                               // 'AFV level' is an obsolete feature
    Flag = TRUE                                 // Flag referenced at end of procedure
  ELSE -- not AFV level
    IF input is 'force embedder on'
      Flag = FALSE
    ELSE
      IF standard or MADI input to EMB output
        Flag = TRUE
      ELSE
        Flag = FALSE
      ENDIF
    ENDIF -- force embedder
  ENDIF -- AFV level
ELSE -- audio matrix take
  IF null audio source                         // do "embedder group control"
    IF MADI destination
      Return "Invalid Destination"           // no nulls to MADI output
    ELSE
      Set audio source
      Set 'Insert Silence' flag
      Flag = TRUE
    ENDIF
  ELSE -- regular audio source
    IF standard input
      Return "Invalid Source"                 // can't route audio from std source
    ELSE
      IF standard or "!EM" output             // !EM a special output card
        Return "Invalid Destination"         // can't route audio to such dests
      ELSE
        Set audio source
        Clear 'Insert Silence' flag
        IF DIS or MADI input to EMB or MADI output
          Flag = FALSE
        ELSE
          Flag = TRUE
        ENDIF
      ENDIF -- valid dest
    ENDIF
  ENDIF
ENDIF
```

```

        ENDIF -- valid source
    ENDIF -- null or not
ENDIF video or audio
IF Flag
    bypass embedder and tally effective status
ELSE
    use embedder and tally actual status
ENDIF

```

Notes:

- 1 The objective of the logic is to determine whether to bypass the embedder and whether to set the 'Insert Silence' flag. The 'Insert Silence' flag governs whether the null audio source is used.
(The 'Insert Silence' flag — or 'null' flag — is part of the pass-through logic of disembedder/embedder outputs.)
- 2 The "force embedder" attribute is specified in MRC's 'Input Attributes' page.
- 3 The embedder of disembedder/embedder output cards is always on and is not bypassed. The "force embedder" attribute is not used for disembedder/embedder outputs.

Embedded Group Control

SDI video signals can carry up to 16 audio channels. We say the channels are *embedded* in the video. The channels are organized into 4 groups of 4 channels each.

An NV8500 router can force embedded audio channels to be null at output. If all 4 channels of an embedded audio group are null, the group is null too. That is,

If a single channel is null, the output's embedder inserts silence for that channel.

If all 4 channels of an audio group are null, the embedder will omit the group from its outgoing data stream.

Routing a null source to an output is under operator control (or under control of automation).

Two conditions are required for the router to be able to do this:

- In MRC, you must define a "null audio source" for the router.
- An operator must perform takes of the designated null source(s) to the selected audio channels of the intended destination.

A "null audio source" can be any of the inputs in a synchronous audio partition of the router. It is recommended that you use a port number of one of a disembedder card's unused video ports (one where the video port number is a multiple of 9). See [Router Levels Page](#) on page 37.

Nothing of the audio port's signal is used. The "null audio source" is an artifice that tells router firmware to handle the destination's targeted audio channel(s) in a certain way.

A port designated as the "null audio source" cannot also be used as a normal audio source.

- ▲ The use of embedded group control is not compatible with DHP.
- ▲ If a null source is routed to a MADl output, the take is rejected.
- ▲ Only NV8500 family routers (at firmware version 3.1 or later) support embedded group control.

Pass-Through Sources

“Pass-through” is a concept designed with respect to the disembedder/embedder output cards of NV8500 family routers.

The concept of pass-through was created to allow panel operators to take audio from standard input cards to hybrid output without an extraordinary amount of effort. It is the disembedder/embedder output card that performs pass-through.

Each output of a disembedder/embedder card has logic that allows “pass-through” (as well as null audio). Figure 6-2 illustrates one such output:

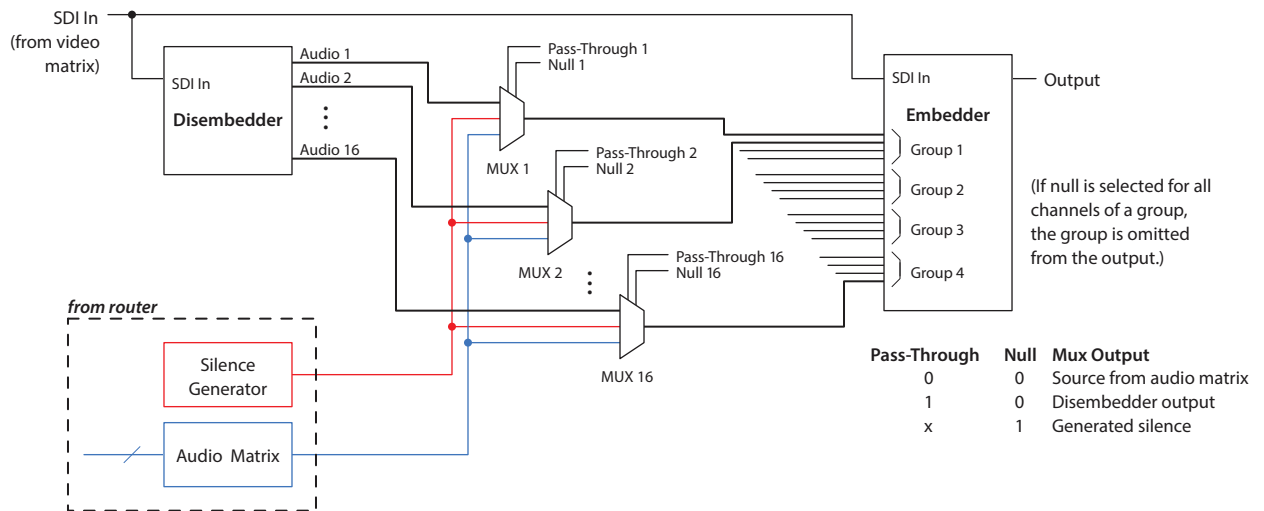

Fig. 6-2: Output of Disembedder-Embedder Card

The output path has a disembedder that extracts the audio from the video source and an embedder. Each audio channel of the embedder receives one of 3 multiplexed inputs:

- An audio channel i from the disembedder.
- Silence.
- An audio signal from the router’s audio matrix.

Each embedder channel has a ‘null’ flag (i.e., the ‘Insert Silence’ flag) set by the logic of embedded group control. (See [Embedded Group Control](#) on page 141.) If the channel’s null bit is set, the EGC logic will drop the entire group if all its null bits are set. Otherwise, the channel carries generated silence.

If the embedder’s audio channel is not null, the audio comes from the disembedder if the channel’s pass-through bit is set. Otherwise, the audio comes from the router’s audio matrix.

Basic and Extended Pass-Through

Panel operators are given the choice of basic pass-through and extended pass-through:

- **Basic.** The operator routes an audio source designated as the basic pass-through source to an output. The actual result (given a correct NV9000-SE Utilities configuration) is that all 16 audio output channels are taken from the video at the output.
- **Extended.** The operator can route individually up to 16 audio sources configured as “extended” pass-through sources to the output. The audio outputs represented by those pass-through sources are taken from the video at the output.

The panel operator must be aware of the names (configured in NV9000-SE Utilities) of the basic pass-through source and the individual "extended" pass-through sources.

Configuring Pass-Through

Pass-through configuration is performed in MRC and in NV9000-SE Utilities. Pass-through sources can then be used as often as required by panel operators.

To configure pass-through in MRC, go to the 'Router Levels' page. Specify (1) a basic pass-through source in the 'Pass-Thru Audio Source' field and (2) up to 16 extended pass-through sources in the 'Pass-Thru Shuffle Audio Sources' table. These sources will be sacrificed: you cannot use the pass-through source as a normal source. Therefore, choose unused audio port numbers for pass-through sources.

Basic Pass-Through Source

In NV9000-SE Utilities, create an audio source device whose port number is the same as the basic port number you entered in MRC's router levels page. This source should *not* have a video level. Name the source "passthru" or something similar that is acceptable to panel operators.

After the router and the NV9000 control system are configured and running, control panel operators may use the designated pass-through source to perform pass-through routes.

Panel operators make a *basic* pass-through route by taking the pass-through audio source to the desired destination.

When the router detects that the pass-through source was selected, it does *not* route audio from the pass-through source, but sets the pass-through flags for all 16 audio channels. These flags tell the output to use the corresponding disembedder channel output in the output stream. Refer to Figure 6-2 on page 142.

Extended Pass-Through Sources

There are several ways to configure pass-through audio sources in NV9000-SE Utilities. The different methods are used in different ways and have different purposes.

Method 1

Create a (single) source device whose individual audio port numbers are the same as the numbers you entered in the 'Pass-Thru Shuffle Audio Sources' table of MRC's router levels page.

This source should have as many audio levels as your video signals carry. It does not matter whether the source has a video level. Name the source something that is acceptable to panel operators as a pass-through source.

After the router and the NV9000 control system are configured and running, control panel operators may use the designated pass-through source to perform pass-through routes.

Thus, if the MRC pass-through list is . . .

1	129	5	133	9	137	13	141
2	130	6	134	10	128	14	142
3	131	7	135	11	138	15	143
4	132	8	136	12	140	16	144

... then your source, defined in NV9000-SE Utilities, would have levels

Audio 1 = 129
Audio 2 = 130,
...
Audio 16 = 144.

Taking this source (directly) to an output (of a disembedder/embedder card) will route all the audio channels of the video at the output straight through to the output without shuffle.

A shuffle could be accomplished if the panel operator is willing to perform a level mapping.

The second method, discussed next, addresses shuffling.

Method 2

Create multiple source devices whose individual port numbers are the same as the numbers you entered in the 'Pass-Thru Shuffle Audio Sources' table of MRC's router levels page.

You should create a source device for each of the pass-through audio sources in the table. Each source device has just one level that matches a pass-through source you defined in MRC. Name these sources in a way that is acceptable to panel operators. We recommend you create a category for these sources. A panel operator will then be able to select any pass-through channel with just 2 button presses.

After the router and the NV9000 control system are configured and running, control panel operators may use the designated pass-through sources to perform pass-through routes with shuffle.

Panel operators make an *extended* pass-through route by creating a breakaway of the individual pass-through audio channels from the defined pass-through source to the desired destination.

Thus, if the MRC pass-through list is ...

1	129	5	133	9	137	13	141
2	130	6	134	10	128	14	142
3	131	7	135	11	138	15	143
4	132	8	136	12	140	16	144

... then your 16 sources, defined in NV9000-SE Utilities, would have levels

Source Name	Level	Port
Pass1	Audio 1	129
Pass2	Audio 2	130
...		
Pass16	Audio 16	144

and the category could perhaps be named PASSTHRU.

The general procedure for performing pass-through takes (with shuffle) is:

- 1 Selects a destination.
- 2 Select a destination level (say Audio 3).
- 3 Choose a pass-through source (say Pass12).
(Taking pass12 to audio 3 of the destination means that audio channel 12 of the video at the output is taken to audio channel 3 of the output.)
- 4 Repeat steps 2 and 3 for any other portions of the overall audio shuffle you want to achieve.
- 5 Press 'Take'.

This method gives operators independent control of all pass-through channels (or as many pass-through channels as you want your system to have).

Notes

When the router detects that the pass-through source was selected, it does **not** route audio from the pass-through source, but sets the pass-through flags for the chosen audio levels. Each flag tells the output to use the corresponding disembedder channel output in the output stream. Refer to Figure 6-2.

- ▲ A port designated as the “pass-through source” cannot also be used as a normal source.
- ▲ “Pass-through” audio is **not** compatible with DHP.
- ▲ If a pass-through source is “taken” to an output that is not on a disembedder/embedder card, the take is rejected (with an error message).
- ▲ Only NV8500 family routers (at firmware version 3.3.1 or later) support pass-through audio.

Synchronous Stereo Audio Level

in the 'Router Levels' page, you can define a 'Synchronous Stereo Audio' level. The stereo level (or partition) occupies the audio matrix of the NV8500 hybrid router and probably overlaps the 'Synchronous Audio' partition partially or completely. The stereo level combines the "mono" audio ports (of the synchronous audio level) into stereo pairs. For every two mono ports, there is one designated stereo "port." If the size of the synchronous audio partition is N, a matching stereo partition is N/2. For example, if the synchronous audio partition has 9216 ports, the matching stereo partition has 4608 ports.

Stereo Port Numbers

Given a stereo port number S, the mono ports (L, R) that compose the stereo pair are:

$$L = S \times 2 - 1$$

$$R = S \times 2$$

Examples

Stereo	Left	Right
1	1	2
2	3	4
3	5	6
...
4608	9215	9216

Given a mono port (M, either left or right, even or odd) that is part of a stereo pair, the stereo "port," S, is:

$$S = (M - 1) / 2 + 1 \quad [\text{integer division}]$$

Examples

Mono	Formula	Stereo
1	$(1-1)/2 + 1$	1
2	$(2-1)/2 + 1$	1
3	$(3-1)/2 + 1$	2
4	$(4-1)/2 + 1$	2
5	$(5-1)/2 + 1$	3
6	$(6-1)/2 + 1$	3
...		
9215	$(9215-1)/2 + 1$	4608
9216	$(9216-1)/2 + 1$	4608

Crosspoint Page

In the crosspoint page, it is possible to view the audio matrix of an NV8500 hybrid router as a 'Synchronous Audio' level or as a 'Synchronous Stereo Audio' level.

Typically these are the same audio ports, but represented differently. The two levels might or might not overlap. Where there is an overlap of the levels, making a change (e.g. performing a take) in one crosspoint view will affect the data displayed in the other crosspoint view.

That is, performing certain “mono” take in the ‘Synchronous Audio’ view will create breakaway conditions in the stereo view. Performing a take in the stereo view will show two resulting mono takes in the ‘Synchronous Audio’ view.

Example 1

Three takes were made in the ‘Synchronous Stereo Audio’ view:

Destination	Source	Locked	Protected	LID	Status
1	7	<input type="checkbox"/>	<input type="checkbox"/>	0	Success
2	8	<input type="checkbox"/>	<input type="checkbox"/>	0	Success
3	5	<input type="checkbox"/>	<input type="checkbox"/>	0	Success
4	4	<input type="checkbox"/>	<input type="checkbox"/>	0	
5	5	<input type="checkbox"/>	<input type="checkbox"/>	0	
6	6	<input type="checkbox"/>	<input type="checkbox"/>	0	
7	7	<input type="checkbox"/>	<input type="checkbox"/>	0	
8	8	<input type="checkbox"/>	<input type="checkbox"/>	0	

Switching to the ‘Synchronous Audio’ (i.e., mono) view, the corresponding mono ports have changed:

Destination	Source	Locked	Protected	LID	Status
1	13	<input type="checkbox"/>	<input type="checkbox"/>	0	
2	14	<input type="checkbox"/>	<input type="checkbox"/>	0	
3	15	<input type="checkbox"/>	<input type="checkbox"/>	0	
4	16	<input type="checkbox"/>	<input type="checkbox"/>	0	
5	9	<input type="checkbox"/>	<input type="checkbox"/>	0	
6	10	<input type="checkbox"/>	<input type="checkbox"/>	0	
7	7	<input type="checkbox"/>	<input type="checkbox"/>	0	
8	8	<input type="checkbox"/>	<input type="checkbox"/>	0	
9	9	<input type="checkbox"/>	<input type="checkbox"/>	0	
10	10	<input type="checkbox"/>	<input type="checkbox"/>	0	

Stereo pair 7 was taken to stereo output 1. Using the formulas, that is equivalent to mono ports 13 and 14 being taken to outputs 1 and 2 respectively.

The results are similar for ports 15, 16, 9, and 10.

Example 2

One mono take was made in the ‘Synchronous Audio’ view:

Destination	Source	Locked	Protected	LID	Status
1	13	<input type="checkbox"/>	<input type="checkbox"/>	0	
2	14	<input type="checkbox"/>	<input type="checkbox"/>	0	
3	15	<input type="checkbox"/>	<input type="checkbox"/>	0	
4	16	<input type="checkbox"/>	<input type="checkbox"/>	0	
5	9	<input type="checkbox"/>	<input type="checkbox"/>	0	
6	10	<input type="checkbox"/>	<input type="checkbox"/>	0	
7	7	<input type="checkbox"/>	<input type="checkbox"/>	0	
8	8	<input type="checkbox"/>	<input type="checkbox"/>	0	
9	9	<input type="checkbox"/>	<input type="checkbox"/>	0	
10	16	<input type="checkbox"/>	<input type="checkbox"/>	0	Success

Taking input 16 to port 10 causes a breakaway, with respect to the stereo port:

Destination	Source	Locked	Protected	LID	Status
1	7	<input type="checkbox"/>	<input type="checkbox"/>	0	Success
2	8	<input type="checkbox"/>	<input type="checkbox"/>	0	Success
3	5	<input type="checkbox"/>	<input type="checkbox"/>	0	Success
4	4	<input type="checkbox"/>	<input type="checkbox"/>	0	
5	5	<input type="checkbox"/>	<input type="checkbox"/>	0	Breakaway
6	6	<input type="checkbox"/>	<input type="checkbox"/>	0	
7	7	<input type="checkbox"/>	<input type="checkbox"/>	0	
8	8	<input type="checkbox"/>	<input type="checkbox"/>	0	

For breakaway not to be present here, either the pair 9 and 10 or the pair 15 and 16 must have been routed to the output pair 9 and 10.

IOXM Extended Status Data

The following table represent the data that can appear in the 'Individual Module Status' section of MRC's 'Module Status' page.

Module Types

Not all modules provide extended status. These are the modules that do:

Inputs

EM0687	AES async, 9-input
EM0783	Standard, 3Gig, 9 -input, coax
EM0783	Standard, 3Gig, 9 -input, coax, for NV8144
EM0783	Standard, HD, 9-input, coax
EM0814	Hybrid disembedder, 3Gig, 8-input, coax
EM0814	Hybrid 3Gig, 8 Video, 1 MADl, coax
EM0902	Standard, 3Gig, 9 -input, coax
EM0902	Standard, 3Gig, 9 -input, coax, for NV8144
EM0902	Standard, HD, 9-input, coax
EM0903	Hybrid disembedder, 3Gig, 8-input, coax
EM0903	Hybrid 3Gig, 8 Video, 1 MADl, coax

Outputs

EM0688	AES async, 18-output
EM0785	Standard, 3Gig, 18 -output, coax
EM0815	Hybrid embedder, 3Gig, 16-output, coax

Crosspoints

EM0662	Standard 288×288 crosspoint, 3Gig
EM0676	Standard 288×288 redundant crosspoint, 3Gig
EM0799	Standard 144×144 crosspoint, 3Gig
EM0819	Hybrid 144×144 crosspoint, 3Gig
EM0894	Standard 144×144 crosspoint, 3Gig

Crosspoints

EM0895	Standard 144×144 redundant crosspoint, 3Gig, for NV8140
--------	---------------------------------------------------------

EM0896	Standard 288×288 crosspoint, 3Gig
--------	-----------------------------------

Extended status data are not available for any other modules. MRC reports "N/A."

Video Formats

These are the (identifiers for the) video formats accepted by the NV8500 routers:

720p60, 720p59.94, 720p30, 720p29.97, 720p25, 720p24, 720p23.98, 720p50

1080i60, 1080i59.94, 1080i50, 1080i48

1080p25, 1080p30, 1080p29.97, 1080p60, 1080p59.94, 1080p50, 1080p24, 1080p23.98

525i59.94 (NTSC), 625i50 (PAL)

If MRC does not recognize the video format, it reports "unknown."

IOXM Extended Status Reporting

Following are the data reported for various module types:

Standard Input

Path Light (whether the module's path light is on).

Rear (whether the backplane module in the slot is present and appropriate for the module).

Temperature (8-bit value in degrees centigrade).

Input carrier detect (a 9-bit string of 1s and 0s, one bit for each input, indicating whether a signal is present at the input).

Standard Output

Path Light

Rear

Temperature

Output Reclocker (an 18-bit string of 1s and 0s, one bit for each output).

▲ "Output reclocker" simply means that there is video present at the output. There is no relationship in this status field to reclockers or to the bypass flags found in the 'Output Attributes' page.

Hybrid Output

Path Light

Rear

Temperature

Output Reclocker (in the bit string, bits 9 and 18 are always 0).

Video rate and format for each output. Outputs 9 and 18 are of course reported as "N/A."

Hybrid Input

Path Light

Rear

Temperature

Input carrier detect (18 bits for NV8140 input cards, 9 bits for input cards of other NV8500 routers).

Video rate and format (18 values for NV8140 input cards, 9 values for input cards of other NV8500 routers).

MADI Input

Path Light

Rear

Temperature

Input carrier detect (18 bits for NV8140 input cards, 9 bits for input cards of other NV8500 routers).

Video rate and format (18 values for NV8140 input cards, 9 values for input cards of other NV8500 routers).

MADI input valid (2 bits, 1s or 0s, for connector 9 and, for NV8140s, connector 18).

AES Input

Path Light.

Rear.

Temperature.

AES Output

Path Light.

Rear.

Temperature.

Standard Crosspoint (EM0986)

Path Light.

Active/Inactive (Whether the crosspoint is active is reported by the card, but not reported in MRC.)

Temperature (five 8-bit values because the module has 5 temperature sensors).

Standard Crosspoint (EM0662)

Path Light.

Active/Inactive (Whether the crosspoint is active is reported by the card, but not reported in MRC.)

Temperature (two 8-bit values because the module has 2 temperature sensors).

Std Redundant XPT

Path Light.

Active/Inactive (Whether the redundant crosspoint is active is reported by the card, but not reported in MRC.)

Temperature (two 8-bit values because the module has 2 temperature sensors).

Hybrid Crosspoint (144×144)

Path Light.

Active/Inactive (Whether the crosspoint is active is reported by the card, but not reported in MRC.)

Temperature (two 8-bit values).

TDM link in use (a 16-bit string of 1s and 0s, one bit for each input card associated with the crosspoint card).

G

Glossary

3Gig	Video at 2.97 or 2.967 Gbps. In Miranda routers, 3Gig cards support HD and SD signals as well. Video at 3Gig conforms to SMPTE standard 424M.
Active Control Card	A router may have both a primary and a secondary control for redundancy. One of the two control cards is the active card and the other is inactive or <i>stand-by</i> .
AES	A term used to represent the digital audio format (AES3id) generally supported at Miranda and switched by NVISION series routers. AES is an abbreviation of the Audio Engineering Society, Inc., New York (www.aes.org).
AES/EBU	(Audio Engineering Society/European Broadcasting Union) a professional serial interface for transferring digital audio from CD and DVD players to amplifiers and TVs. AES/EBU is typically used to transmit PCM and Dolby Digital 5.1, but is not tied to any sampling rate or audio standard.
AES3, AES3id	NVISION series routers that switch audio generally support AES3id and provide 75Ω BNC connectors. AES3id is specified for 75Ω coaxial cable up to 1000 meters. (AES3 uses 110Ω shielded twisted pair (STP) cable, with XLR connectors, up to a distance of 100 meters.)
Analog Audio	A signal whose varying voltage represents the waveform of the audio.
Async AES, Sync AES	The term “Async AES” refers to an asynchronous (free-running) AES-compliant audio signal, whereas “Sync AES” refers to a synchronous (clocked) AES signal with a data rate of 48,000 samples per second.
AVC	Analog Video Conversion. A simple conversion from composite analog video input to an SD digital output or vice versa.
Device	As the term is used in an NV9000 router control system, a device is a grouping of input and output ports, possibly spanning multiple routers of different types. For example, a system might have 3 levels: video, AES, and time code. A hypothetical device in this system is camera 1, which has video on input 1 of the video router, AES on input 5 of an AES router, and time code on input 8 of a time code router.
EEPROM	(EE or “serial EE” for short). Electrically erasable programmable read-only memory. In the context of MRC, this is non-volatile memory on a router control card. EE keeps retains its data indefinitely in the field (unless it is reprogrammed).
HD	HD and HD-SDI are equivalent terms in Miranda terminology. An HD signal is a high-definition video format that conforms to the SMPTE 292M standard.
Active Control Card	A router may have both a primary and a secondary control for redundancy. One of the two control cards is the active card and the other is inactive or <i>stand-by</i> .
I/O	Inputs and outputs.
Matrix	In general, a 2-dimensional array. In NVISION series routers, the switching mechanism is called a <i>crosspoint matrix</i> , that is, a 2-dimensional array of crosspoints. A crosspoint is a theoretical point where an input is connected to an output.
Module	Any removable or replaceable subassembly. In MRC, a module is an input card, output card, monitor card, control card, or a crosspoint card.

MRC	Miranda Router Configurator. A software application that configures and manages NV8500 family routers primarily and other NVISION series routers as well.
Physical Level	<p>A physical level is a partition in a router. Often the router has a single partition and that partition is the entire router. The idea is that multiple routers provide different “levels” on which to switch the signals of devices in the router control system.</p> <p>Any particular device might send or receive HD, SD, AES, time-code, or machine-code signals. A routing switch, or “take,” can occur on multiple physical levels—often in multiple routers—simultaneously.</p>
Port	<p>A port is a connection on a router. There are <i>input</i> ports, <i>output</i> ports, and <i>control</i> ports.</p> <p>An input port or output port is numbered, and usually corresponds to a physical connector, but in the case of MADi, up to 64 ports are time-multiplexed on a single connector.</p>
Reference Signal	A video reference is a timing signal used to synchronize the switching of video signals during a specific portion of the vertical retrace interval. An AES reference signal synchronizes the switching of AES signals.
RAM	Random Access Memory. (Contrasted with archaic sequential access memory.)
RS-422	A bidirectional serial communication standard. NVISION series routers usually have a DE-9 connector for RS-422 communication.
SD, SDI	SD and SDI are equivalent terms in Miranda terminology. An SD signal is a standard-definition, video format that conforms to the SMPTE 259M standard.
SMPTE	Society of Motion Picture and Television Engineers. An international professional association, based in the United States.
Source/Destination	<p>The term “source device” is used interchangeably with “source” and the term “destination device” is used interchangeably with “destination.” A <i>source</i> is a device (such as a camera or satellite feed) that is connected to one or more input ports of a router. A <i>destination</i> (such as a monitor or transmitter link) is a device that is connected to one or more output ports.</p> <p>A device can be both a source and destination. An example of such a device is a VTR.</p>
SWB	(Super Wide Band). A term originating at Miranda that refers to the ability of a router to pass a wide range of digital video formats. Miranda’s SWB supports data rates from about 15 Mb/s to 1.5 GB/s. (This term does not include 3Gig signals.)
Sync AES, Async AES	The term ‘Async AES’ refers to an asynchronous (free-running) AES-compliant audio signal, whereas ‘Sync AES’ refers to a synchronous (clocked) AES signal with a data rate of 48,000 samples per second.
System administrator	In this document, a system administrator is a person responsible for installing, configuring, or maintaining a router control system, including configuration workstations, routers, and control panels.
System Controller	The name given to an NV9000. An NV9000 router control system includes one or more NV9000 system controllers.

Index

Symbols

.rf files	35, 73
.salvo files	105
.zip files	70, 124

0–9

1080i	136
1080p	136
3Gig	25, 134
defined	153
720p	136

A

About (page)	15
Active control card	19
defined	153
Active only (option)	61
Add device (button)	122, 124–125
Add device (dialog)	123–125
Add level (button)	41
Add new output (command)	83, 102
Add new output ... (button)	104
Add new outputs (dialog)	104
Add new outputs/destinations (check box)	101
Adding	
control cards	122–123
levels	41
router levels	41
virtual cards	123
AES reference	51–52, 72
defined	154
AES, defined	153
AES/EBU, defined	153
AES3	153
AES3id	153
Africa, contact	165
Agreement, license	iii
Alarms (state of)	107–108
All control cards (tab)	19–20
All locations (option)	67
Always (option)	61
Americas, contact	165

Analog audio, defined	153
Applying locks when closing MRC	126
Asia, contact	165
Async AES, defined	153
Attributes table, output	53
Audio diagnostic (level)	81, 85
Audio Engineering Society	153
Audio levels	85
Audio range take (command)	22, 84
Audio range take (dialog)	89
Audio range takes	88–89
Audio source, null	141–142, 148
Audio source, pass-through	45
Auto timer	93
Automated takes (for testing)	92–93
AVC, defined	153

B

Basic pass-through	37–38
Black text	64
Blue circles	16, 121, 124–125
Blue text	95, 99, 101
Browse (button)	37
Browse ... (button)	125
Buttons	
add device	122, 124–125
add level	41
add new output ...	104
browse	37
browse ...	125
check all	71
choose	29, 35
copy settings	73
create virtual control card	124
crosspoint	104
dec	93
delete level	43
don't apply	17
don't upgrade	11
execute	89, 92
import configuration	70
import virtual control card	125
inc	93
input/source	100
lock selected cards and exit	126
network interfaces	119, 130

- none 93
 - open in new window 108
 - open salvo 103
 - preview final results 101
 - print 37, 68–69
 - print status 108
 - read all 53, 55
 - read outputs 53, 55
 - refresh list 9, 120
 - refresh summary 17, 106, 110
 - remove device 122, 125
 - salvo 103
 - save 37
 - save status 108
 - select 32, 36
 - select all 32, 36, 54, 126
 - select if needs update 32, 36
 - select none 32, 36, 126
 - start 93
 - stop 93
 - take 92
 - uncheck all 71
 - update control card 17, 42–43, 55–56, 61–62, 66, 68–69
 - update firmware 32, 36
 - update settings 119, 128
 - upgrade now 11
 - upgrade on exit 11
 - view change report 67, 115
 - view past update logs 37
 - view status report 115
- C**
- Card slots 63
 - Change history iii
 - Change report 115
 - Changing column size 21
 - Changing modules 68
 - Check all (button) 71
 - Check boxes 20, 70
 - China, contact 165
 - Choose (button) 29, 35
 - Clear all locations without actual modules (command) 66
 - Column size 21
 - Command icons 22
 - Commands
 - keyboard 22
 - table 20
 - Communication settings 57
 - Configuration (section) 14, 27
 - Configuration files, external 70
 - Configuration locked 24
 - Configuration locked (check box) 126
 - Configuration PC 2, 119, 130
 - Configurations
 - copying 123
 - locking and unlocking 16, 72, 121, 126
 - save as virtual card 123
 - saving 17
 - Configurator tools (section) 15
 - Configuring
 - PC 2
 - serial ports 61
 - slots 63
 - Connectors
 - DE-9 131
 - RJ-45 131
 - Contact Miranda 165
 - Context menu 22–23, 50, 65, 69, 77
 - global 23
 - in crosspoints page 83
 - output attributes 54
 - Control (ctrl) key 22
 - Control 1 and 2 Baud rate setting 59, 61
 - Control 1 settings 59, 61
 - Control 2 settings 59, 61
 - Control card
 - active 19
 - bus type 60
 - data, copying 69
 - inactive 19
 - selection 16
 - settings 58–59
 - standby 19
 - status 107–108
 - Control cards 119
 - adding 122
 - deleting added cards 125
 - location of 63
 - removing 122
 - updating 17
 - virtual 70
 - Control cards (tab) 15–16, 18–19, 23, 35, 43, 61–62, 76–77, 86, 95, 104, 106, 108, 126
 - Control cards, virtual 123
 - Controller destination end 40
 - Controller destination start 40
 - Controller dests 20
 - Controller source end 40
 - Controller source start 40
 - Controller sources 20
 - Copy (command) 22, 83, 98, 100, 102
 - Copy settings 67
 - Copy settings (button) 73
 - Copy settings (page) 14, 27, 69
 - Copy to (table) 69, 71
 - Copying configurations 123
 - Copying control card data 69
 - Copying crosspoint data 98, 100

Corporate office, contact	165
Create salvo (command)	22, 83, 96, 103
Create virtual control card (button)	124
Creating salvos	103
Crosspoint (button)	104
Crosspoint (command)	22, 83, 96
Crosspoint cards	63
Crosspoint data	
uploading	104
Crosspoint levels	85
Crosspoint matrices	76, 86, 101, 133
Crosspoint ranges	38
Crosspoints	82, 133
diagnostic	73
salvos	78
snapshots	78
testing	82
Crosspoints (page)	15, 75–76
CTRL 1 port	11, 58–59
CTRL 2 port	11, 58–59
Ctrl key	22
Current (tab)	77, 80, 82, 86, 95
Customer support	165

D

DE-9 connectors	131
Dec (button)	93
De-embedder	25
Delete (command)	22, 102, 104
Delete level (button)	43
Delete output (command)	83
Deleting	
added control cards	125
control cards	122
levels	42–43
router levels	42
salvos	105
DEM	25, 111
Destinations	132–133
defined	154
Destinations, locking, protecting	78
Device, defined	153
Device ID (drop-down menu)	124
Device names	72
DIAG port	58–59
Diagnostic crosspoints	73
Diagnostic levels	77, 85
Diagnostic port settings	59
Diagonal take (command)	22, 84
Diagonal take (dialog)	91
Diagonal takes	82, 87, 90–91, 94
Different subnet	10
Disembedder	25, 111
DNS	130

Document revision	iii
Document, notice of use	iii
Dolby Digital 5.1	153
Don't apply (button)	17
Don't upgrade (button)	11
Dot, orange	18
Dot, red	115
Drop-down lists	21
Dual reference	51–52, 55, 72, 139

E

EEPROM	17
defined	153
EM0666 control card	12
EM0833 control card	12
E-mail address	165
EMB	25, 111
Embedded group control	141–142, 148
Embedder	25
Embedder	111
Embedder output	49
Embedder state, forced	48–49
Errors, module types	67
Ethernet	130
Ethernet settings (page)	9, 14, 117, 119
Ethernet switches	129, 131
Europe, contact	165
European Broadcasting Union	153
Excel files	98, 105
Execute (button)	89, 92
EXP	111
Expanded - expansion (option)	59, 62
Expanded - main (option)	59, 62
Expansion	19, 57
Expansion frame (option)	67
Expansion frames	19, 24, 57, 61–62
Expansion settings	59, 61–62, 72
Expansion: LI-nnn	50
Expansion: UI-nnn	50
Export configuration (command)	24
Exporting configurations	70, 123
Extended pass-through	37–38
External configuration files	70

F

Fans, status	107–108
fax number	165
FCC statement	iii
Fields, video	51, 54, 135
FILLER	111
Filter, module types	64
Filter, output	84

Firmware 29
 logs 37
 updating 28, 32
 Firmware (.rf) files 35, 73
 Forced embedder state 48–49
 Frame information 107–108
 Frame sync 111
 Frames
 main expansion 62
 main, expansion 14, 19, 24, 57, 61, 67
 video 51, 54, 135
 France, contact 165
 Firmware (page) 14
 From device (table) 69, 71

G

Gateway IP address 72, 121–122, 127, 130–131
 Getting started 1
 Global context menu 23
 Green circles 16, 121–122
 Grey circles 16, 121–122

H

HD 25, 51
 defined 153
 HD/SD (option) 53–54, 56
 Help, online 15
 High-definition (HD) 25
 Highlighting 20
 History (tab) 77, 82, 94–95
 Hours of operation 165
 HYBRID 111
 Hybrid routers 11–12, 41, 48, 63, 80, 90, 109, 115, 135
 Hybrid routers (tab) ... 16, 18–19, 48, 63, 68–69, 109–110

I

I/O cards 63
 Icons 16, 22, 83, 96, 121–122, 124–125
 iControl-Solo 120
 Import configuration (button) 70
 Import virtual control card (button) 125
 Importing a configuration file 125
 Importing configurations 123
 Inactive control card 19
 defined 153
 Inc (button) 93
 Incrementing takes (tab) 77, 82, 92–93
 I-nnn 50
 Input attributes (page) 14, 27, 48

Input locations only (option) 67
 Input/source (button) 100
 Installation, verification 9
 Installing MRC 2, 6, 9
 Internet protocol (TCP/IP) 3
 Introduction 1
 IOXM cards 25, 36, 109–110
 IP address 2, 10, 20, 72, 117–119, 121–122, 127, 130
 updating 119
 IP address, gateway 72, 121–122, 127, 130–131
 IP conflict 9

J

Jump to output (command) 22, 84, 96
 Jump to output (dialog) 84–85

K

Keyboard commands 22
 Keyboard shortcuts 22

L

Level, physical, defined 154
 Levels 72
 adding 41
 audio 85
 crosspoint 85
 deleting 42–43
 diagnostic 77, 85
 monitor 85
 physical 37, 77, 85, 132, 134
 router 38
 selecting 85
 video 85
 virtual 37, 132
 Levels (tutorial) 134
 LI 25
 license iii
 LID 78, 82
 Links to tools 18
 LI-nnn 50
 Lists, dropdown 21
 Live changes 78
 LO 25
 Local area connection 2–3
 Local physical (settings) 60, 62
 Location of modules 63
 Lock configuration settings (window) 127
 Lock owner 78
 Lock selected cards and exit (button) 126

Locking and unlocking configurations ... 16, 72, 121, 126
 Locking configurations 24
 Locking or protecting destinations 78
 Locks and protects78–79, 126
 Logs (page) 15, 75, 106
 Logs, viewing115
 Lower input 25
 Lower output 25

M

m.n notation 81
 MADI 25, 111
 MADI cards41, 80
 Main and expansion frame (option) 67
 Main frame (option) 67
 Main frames 19, 24, 57, 61–62
 Main, expansion frames 14
 Main: LI-nnn 50
 Main: UI-nnn 50
 Matrices, crosspoint 76, 86, 101, 133
 Matrix, defined 153
 Menu options 83
 Menu, context 22–23, 50, 54, 65, 69, 77, 83
 Menus, drop-down 21
 Menus, Keyboard shortcuts 22
 Middle East, contact 165
 Miranda, contact 165
 Miscellaneous (page) 14, 27, 57
 Module changes 115
 Module selection rule 32
 Module status 115–116
 logs 115
 viewing 115
 Module status (page) 15, 75, 109
 Module type errors, troubleshooting 67
 Module types 66, 72
 change 68–69
 errors 67
 validating 67
 Module types (page) 14, 27, 63
 Module types filter 64
 Module, defined 153
 Modules 63
 location of 63
 status 109
 Monitor cards 63
 Monitor diagnostic (level) 85
 Monitor levels 85
 Mono and stereo switching 135
 Mono audio diagnostic (level) 85
 MRC network 117–119, 129
 MRC software updates 11
 MRC summary 11

MRC user interface18
 MRC, installing 2, 6, 9

N

Navigation pane 13, 18
 Network
 errors9
 switches 131
 Network frame summary 18, 48, 76, 106–107, 110,
 121, 126–127
 Network interface cards119, 130
 Network interfaces (button)119, 130
 Network levels (tab) 18–20
 Network setup (section) 14, 117–119
 Network, MRC 117–119, 129
 NICs119, 130
 Nomenclature 25, 50
 Non I/O locations only (option) 67
 None (button) 93
 Non-existent ports 82, 90
 Notation, **m.n**81
 Notepad 105
 notice, use iii
 NTSC 136
 Null audio source37–38, 141–142, 148
 NV8256, NV8256-Plus 54
 NV8500 hybrid routers ... 41, 48, 63, 80, 90, 109, 115, 135
 NV9000
 router control system 119, 153–154
 system controller119, 154
 NV9000-SE Utilities 37, 41, 131
 NVISION Ethernet protocol11
 NVISION serial protocol11
 NVISION series products (page) 14, 117–118, 130

O

Octets 130
 Office hours 165
 Online help15
 Open in new window (button) 108
 Open salvo (button) 103
 Opening pages18
 Orange dot18
 Ordering21
 Output attributes (check box)72
 Output attributes (page) 14, 27, 50, 139
 Output attributes table53
 Output filter84
 Output location only (option) 67
 Output ranges 53, 55
 Output, embedder 49
 Outputs, locating84

Outputs, viewing	84
Overview of MRC	11
Owner, lock or protect	78

P

Page

about (MRC)	15
copy settings	14, 27, 69
crosspoints	15, 75–76
Ethernet settings	9, 14, 117, 119
firmware	14
input attributes	14, 27, 48
logs	15, 75, 106
miscellaneous	14, 27, 57
module status	15, 75, 109
module types	14, 27, 63
NVISION series products	14, 117–118, 130
output attributes	14, 27, 50, 139
preferences	15
router levels	14, 27, 37, 134
system status	15, 75, 107
update firmware	28
welcome	14
PAL	136
Pane, navigation	13, 18
Part numbers	115
Partition settings	38
Partitions	37, 134
Pass-through audio sources	37–38
Pass-through source	45
Paste (command)	22, 83, 98, 100, 102
Paste crosspoints (dialog)	99
Pasting crosspoint data	98, 100
PC requirements	2
PC, configuration	2, 119, 130
PC, installing MRC	2
PCM (pulse code modulation)	153
Peer card, status	107–108
Performing a diagonal take	90
Performing a range take	88
Performing an audio range take	89
Performing incremental takes	93
Performing takes	76, 82, 87
phone numbers	165
Physical input end	40
Physical input start	40
Physical levels	37, 77, 85, 132, 134
defined	154
Physical output end	40
Physical output start	40
Port, defined	154
Ports	
CTRL 1	11, 58–59
CTRL 2	11, 58–59

DIAG	58–59
input	40
output	40
router control	58
Ports, non-existent	82, 90
Power supplies, status	107–108
Power supply modules	63
Preferences	23
Preferences (page)	15
Preferences (window)	23
Preview final results (button)	101
Print (button)	37, 68–69
Print status (button)	108
Printing system status	108
Protect, owner	78
Protected destinations	78
Protects	78–79, 126
Protocol, NVISION Ethernet	11
Protocol, NVISION serial	11
Protocols	57

R

Radio buttons	21, 100, 124
RAM, defined	154
Range take (command)	22, 84
Range take (dialog)	88
Range takes	82, 87–88, 94
Read all (button)	53, 55
Read outputs (button)	53, 55
Rear diagnostic port settings	59
Re-clock/bypass (option)	53–54, 56
Re-clocking, bypass	51
Red circles	16, 121–122
Red dot	115
Red text	29, 64, 107
Redundant reference	51–52, 55, 139
Re-enabling message windows	23
Reference	
AES	51–52, 72
dual	51–52, 55, 72, 139
redundant	51–52, 55, 139
video	51–52, 55, 136
Refresh list (button)	9, 120
Refresh summary (button)	17, 106, 110
Releasing locks and protects	78–79, 126
Remove device (button)	122, 125
Removing control cards	122
Reports, firmware updates	37
Requirements, PC	2
Reset control card (command)	24
Reverse (check box)	89, 91
Reverse diagonal takes	91
Reverting a crosspoint to a previous state	77
Revision, document	iii

Right-click	22
RJ-45 connectors	131
ROT-16	57, 60
Router control ports	58
Router control system	119, 153–154
Router firmware	28
Router levels	38, 72
adding	41
deleting	42
updating	41
Router levels (page)	14, 27, 37, 134
Router serial settings	59
Router tools (section)	15, 75
crosspoints	15
logs	15
module status	15
system status	15
Routing (tutorial)	131
RS232	59
RS485	59
Rules, module selection	32
Running log	106
Running tasks	93

S

Salvo (button)	103
Salvo (tabs)	77, 82, 86, 101, 105
Salvos	77–78, 99, 101
creating	103
deleting	105
opening	104
updating	103
Save (button)	37
Save as salvo (command)	22, 83, 96, 103
Save status (button)	108
Saving a log file	106
Saving an update log	37
Saving configurations	17
Saving control card settings	123
Saving system status	108
Screen size	23
SD	25, 51
defined	154
SDI	25
Select . . . (button)	32, 36
Select all (button)	32, 36, 54, 126
Select all (command)	66
Select all control card locations (command)	66
Select all crosspoint locations (command)	66
Select all inputs locations (command)	66
Select all monitor locations (command)	66
Select all outputs locations (command)	66
Select all power supply locations (command)	66
Select firmware (dialog)	32–34
Select if needs update (button)	32, 36
Select none (button)	32, 36, 126
Selecting a control card	16
Selecting levels	85
Serial communications settings	72
Serial ports	57
configuring	61
settings	58
viewing	58
Set expansion frames (command)	24
Set selected control card locations to (command)	66
Set selected crosspoint locations to (command)	66
Set selected input locations to (command)	66
Set selected monitor locations to (command)	66
Set selected output locations to (command)	66
Set selected power supply locations to (command)	66
Set selection output embedder (command)	50
Settings to be copied	71
Settings, storing	17
Setup, initial	2
Shift key	22
Shortcuts, keyboard	22
Signal types	133–134
Single take	87
SMPTE	135
defined	154
standards	136
Snapshots, crosspoint	78
software license	iii
Sony	57, 60
Sources	132–133
Sources, defined	154
Stand alone (option)	59
Stand alone (router frame)	19
Standard routers	11–12
Standard-definition (SD)	25
Standby control card	19
Start (button)	93
Startup log	106
Status	
module	109
system	107
Status panels	107–108
Status report	115–116
STD	111
Stereo and mono switching	135
Stop (button)	93
Subnet	2, 20, 72, 121–122, 127, 129–130
Subnet mask	20, 72, 121–122, 127, 130–131
Subnets, multiple	5
support, contact	165
SWB, defined	154
Switch on field boundary (option)	54
Switch on frame boundary (option)	54
Switch on HD line (option)	53, 56
Switch on SD line (option)	53, 56

Switch points 50, 55, 136
 Vertical timing 135
 viewing 51
 Switches, Ethernet 129, 131
 Switching 76, 87
 Switching matrix 76
 Sync AES, defined 154
 Synchronous stereo audio level 38, 41, 45–47
 System administrator, defined 154
 System controller, defined 154
 System status (page) 15, 75, 107

T

Tabbed tables 18
 Table commands 20
 Tables, tabbed 18
 Tables, using 18
 Tabs
 all control cards 18
 control cards 18
 history 94
 hybrid routers 18
 network levels 18
 using 18
 video routers 18
 Take (button) 92
 Take sequences 93
 Takes 76, 79, 87, 94
 diagonal 82, 87
 performing 76, 82, 87
 range 82, 87–88
 single 87
 undoing 94
 TDM 25, 111
 technical support 165
 Testing crosspoints 82
 Third-party systems 11, 57–58
 Tool tips 21
 Trouble-shooting module type errors 67

U

UI 25
 UI-*nnn* 50
 Uncheck all (button) 71
 Undo history (section) 94
 Undoing takes 94
 UniConfig 11
 United Kingdom, contact 165
 Unlock (icon) 79
 Unlock all (command) 22, 79, 84
 Unlock configuration settings (window) 127
 Unlocked warning (window) 126

Unlocking configurations 24, 126–127
 Unlocking destinations 78
 UO 25
 Update (check box) 127
 Update control card (button) ... 17, 42–43, 55–56, 61–62,
 66, 68–69
 Update firmware (button) 32, 36
 Update firmware (page) 28
 Update logs, firmware 37
 Update logs, saving 37
 Update settings (button) 119, 128
 Updates, MRC software 11
 Updating
 control cards 17
 firmware 28, 32
 module types 68–69
 router levels 41
 salvos 103
 Upgrade now (button) 11
 Upgrade on exit (button) 11
 Uploading crosspoint data 104
 Upper input 25
 Upper output 25
 Use selection (check box) 100

V

Verifying
 modules in frame 63
 Verifying installation 9
 Video
 frames and fields 135
 levels 85
 switch points 50
 Video diagnostic (level) 85
 VIDEO REF1 50
 VIDEO REF2 50
 Video reference 51–52, 55, 136
 defined 154
 Video routers (tab) 18–19, 55
 View change report (button) 67, 115
 View past update logs (button) 37
 View status report (button) 115
 Viewing
 change reports 115
 crosspoints 76, 86
 logs 115
 module status 115
 module types 66
 salvos 104
 serial ports 58
 status reports 115–116
 switch points 51
 Virtual control cards 67, 70, 119, 122–123

importing and exporting123
Virtual levels 37, 132

W

Warrantyiii
Web site165

Welcome (page)14
WINS 130

Y

Yellow circles 16, 121–122



Miranda Technical Support

For technical assistance, please contact the Miranda Technical Support center nearest you:

Americas

Office hours: 9:00 a.m. – 9:00 p.m. (EST)
Telephone: +1-800-224-7882
Fax: +1-514-335-1614
E-mail: support@miranda.com

Asia

Office hours: 9:00 a.m. – 5:00 p.m. (GMT+8)
Telephone: +852 2539 6987
Fax: +852 2539 0804
E-mail: asiotech@miranda.com

Europe, Middle East, Africa, UK

Office hours: 9:00 a.m. – 6:00 p.m. (GMT)
Telephone: +44 118 952 3444
Fax: +44 118 952 3401
E-mail: eurotech@miranda.com

China

Telephone: +86 10 5873 1814
E-mail: asiotech@miranda.com

France

Office hours: 9:00 a.m. – 5:00 p.m. (GMT+1)
Telephone: +33 1 55 86 87 88
Fax: +33 1 55 86 00 29
E-mail: eurotech@miranda.com

EMERGENCY after hours (global)

Toll free: 1-800-224-7882 (US and Canada)
Telephone: +1 514 333 1772

Corporate Head Office

Miranda Technologies
3499 Douglas-B.-Floreani, St-Laurent, Quebec, Canada H4S 2C6
Telephone: +1 514-333-1772
Fax: +1 514-333-9828
Web: www.miranda.com



A **BELDEN** BRAND