

DHP

Dynamic Hybrid Pathfinding Service

Reference Manual

UG0060-01

25 Nov 2014



Copyright & Trademark Notice

Copyright © 2014 Grass Valley. All rights reserved.

Belden, Belden Sending All The Right Signals, and the Belden logo are trademarks or registered trademarks of Belden Inc. or its affiliated companies in the United States and other jurisdictions. Grass Valley, NVISION, NV9000, NV9000-SE Utilities, and DHP are trademarks or registered trademarks of Grass Valley. Belden Inc., Grass Valley, and other parties may also have trademark rights in other terms used herein.

Terms and Conditions

Please read the following terms and conditions carefully. By using DHP documentation, you agree to the following terms and conditions.

Grass Valley hereby grants permission and license to owners of DHP routers to use their product manuals for their own internal business use. Manuals for Grass Valley products may not be reproduced or transmitted in any form or by any means, electronic or mechanical, including photocopying and recording, for any purpose unless specifically authorized in writing by Grass Valley.

A Grass Valley manual may have been revised to reflect changes made to the product during its manufacturing life. Thus, different versions of a manual may exist for any given product. Care should be taken to ensure that one obtains the proper manual version for a specific product serial number.

Information in this document is subject to change without notice and does not represent a commitment on the part of Grass Valley.

Warranty information is available in the support section of the Grass Valley web site (www.grassvalley.com).

Title	DHP Reference Manual
Part Number	UG0060-01
Revision	1.1 (25 Nov 14)

Change History

Rev.	Date	ECO	Description	Approved
1.0	21 Apr 09	18826	Initial release.	D.Cox
1.1	25 Nov 14	19357	DHP activation file is SV1062-01. New format. Added Korean compliance statement. Client assignments (in server mode) preserved over power cycles.	D.Cox

Safety Compliance

Korean Compliance (KCC) Statement



KCC-REM-XEI-NV8500

A 급 기기

(업무용 방송통신 기자재)

Class A Equipment

(Commercial Broadcasting & Communication Equipment)

이 기기는 업무용 (A 급) 전자파적합기기로서 판매자 또는 사용자는 이 점을 주의하시기 바라며, 가정외의 지역에서 사용하는 것을 목적으로 합니다.

Please note this is a Class A device. Sellers or users need to take note of this and should not use this equipment in a domestic environment.

FCC Statement

This equipment has been tested and found to comply with the limits for a Class A digital device, pursuant to part 15 of the FCC Rules. These limits are designed to provide reasonable protection against harmful interference when the equipment is operated in a commercial environment. This equipment generates, uses, and can radiate radio frequency energy and, if not installed and used in accordance with the instruction manual, may cause harmful interference to radio communications. Operation of this equipment in a residential area is likely to cause harmful interference in which case the user will be required to correct the interference at his own expense.

CE Declaration of Conformance (CE)

All of the equipment described in this manual has been designed to conform with the required safety and emissions standards of the European Community. Products tested and verified to meet these standards are marked as required by law with the CE mark.

When shipped into member countries of the European Community, this equipment is accompanied by authentic copies of original Declarations of Conformance on file in the Grass Valley offices in Grass Valley, California USA.

Software License Agreement and Warranty Information

Contact Grass Valley for details on the software license agreement and product warranty.

Important Safeguards and Notices

This section provides important safety guidelines for operators and service personnel. Specific warnings and cautions appear throughout the manual where they apply. Please read and follow this important information, especially those instructions related to the risk of electric shock or injury to persons.

WARNING

Any instructions in this manual that require opening the equipment cover or enclosure are for use by qualified service personnel only. To reduce the risk of electric shock, do not perform any service other than that contained in the operating instructions unless you are qualified to do so.

Restriction on Hazardous Substances (RoHs)

Grass Valley is in compliance with EU Directive RoHS 2002/95/EC governing the restricted use of certain hazardous substances and materials in products and in our manufacturing processes.

Grass Valley has a substantial program in place for RoHS compliance that includes significant investment in our manufacturing process, and a migration of Grass Valley product electronic components and structural materials to RoHS compliance.

It is our objective at Miranda GVD to maintain compliance with all relevant environmental and product regulatory requirements. Detailed information on specific products or on the RoHS program at Grass Valley is available from Grass Valley Customer Support at

1-800-719-1900 (toll-free) or
1-530-265-1000 (outside the U.S.).

Symbols and Their Meanings



The lightning flash with arrowhead symbol within an equilateral triangle alerts the user to the presence of dangerous voltages within the product's enclosure that may be of sufficient magnitude to constitute a risk of electric shock to persons.



The exclamation point within an equilateral triangle alerts the user to the presence of important operating and maintenance/service instructions.



The Ground symbol represents a protective grounding terminal. Such a terminal must be connected to earth ground prior to making any other connections to the equipment.



The fuse symbol indicates that the fuse referenced in the text must be replaced with one having the ratings indicated.



The presence of this symbol in or on Grass Valley equipment means that it has been designed, tested and certified as complying with applicable Underwriter's Laboratory (USA) regulations and recommendations.



The presence of this symbol in or on Grass Valley equipment means that it has been designed, tested and certified as essentially complying with all applicable European Union (CE) regulations and recommendations.

General Warnings

A warning indicates a possible hazard to personnel which may cause injury or death. Observe the following general warnings when using or working on this equipment:

- Heed all warnings on the unit and in the operating instructions.
- Do not use this equipment in or near water.
- This equipment is grounded through the grounding conductor of the power cord. To avoid electrical shock, plug the power cord into a properly wired receptacle before connecting the equipment inputs or outputs.
- Route power cords and other cables so they are not likely to be damaged.
- Disconnect power before cleaning the equipment. Do not use liquid or aerosol cleaners; use only a damp cloth.
- Dangerous voltages may exist at several points in this equipment. To avoid injury, do not touch exposed connections and components while power is on.
- Do not wear rings or wristwatches when troubleshooting high current circuits such as the power supplies.

-
- To avoid fire hazard, use only the specified fuse(s) with the correct type number, voltage and current ratings as referenced in the appropriate locations in the service instructions or on the equipment. Always refer fuse replacements to qualified service personnel.
 - To avoid explosion, do not operate this equipment in an explosive atmosphere.
 - Have qualified service personnel perform safety checks after any service.

General Cautions

A caution indicates a possible hazard to equipment that could result in equipment damage. Observe the following cautions when operating or working on this equipment:

- When installing this equipment, do not attach the power cord to building surfaces.
- To prevent damage to equipment when replacing fuses, locate and correct the problem that caused the fuse to blow before re-applying power.
- Use only the specified replacement parts.
- Follow static precautions at all times when handling this equipment.
- This product should only be powered as described in the manual. To prevent equipment damage, select the proper line voltage on the power supply(ies) as described in the installation documentation.
- To prevent damage to the equipment, read the instructions in the equipment manual for proper input voltage range selection.
- Some products include a backup battery. There is a risk of explosion if the battery is replaced by a battery of an incorrect type. Dispose of batteries according to instructions.
- Products that have (1) no on/off switch and (2) use an external power supply must be installed in proximity to a main power outlet that is easily accessible.
- To reduce the risk of electrical shock, plug each power supply cord into a separate branch circuit having a separate service ground.

toc

Table of Contents

1	Introduction	1
	NV8500 Review	1
	I/O Cards	2
	Standard Cards	3
	Disembedder and Embedder Cards	3
	MADI Cards	3
	Expansion Cabling for the NV8576-Plus	3
	DHP Summary	4
	Preliminary DHP Analysis	5
	Other DHP Considerations	6
2	DHP Service	7
	Activation	7
	Definitions	8
	Configuration	9
	Warnings	9
	Summary	9
	Configuration Process	10
	DHP Core	10
	Router Levels	10
	NV9000-SE Configuration	11
	DHP Ports	13
	Initialization—the Configuration Files	13
	‘HybridCards’ Files	14
	‘HybridPorts’ Files	16
	Software Interface	18
	More in NV9000-SE Utilities	18
	Audio for Standard Inputs and Outputs	19
	MADI Port Numbering	19
	Requirements for Adding DHP to a Router	20
	Clear the Crosspoint Matrices	20
	NV9000 Configuration	21
	Start the System with DHP	21
	Setting the Service to Automatic	21
	Starting the Service	23
	Verify	23
	DHP Features	23
	Status	23
	Takes	23
	Standard or Embedder Output	23
	MADI Output	24
	Examples	24
	Standard to Standard	25
	Standard to Embedder	25
	Standard to MADI	26
	Standard to (Standard + MADI)	26
	Standard to (Embedder + MADI)	27

Disembedder to Standard	27
Disembedder to Embedder	28
Disembedder to MADI	28
Disembedder to (Standard + MADI)	29
Disembedder to (Embedder + MADI)	29
MADI to Standard	30
MADI to Embedder	30
MADI to MADI	30
MADI to (Standard + MADI)	31
MADI to (Embedder + MADI)	31
Mixed to Standard	32
Mixed to Embedder	32
Mixed to MADI	33
Mixed to (Standard + MADI)	33
Mixed to (Embedder + MADI)	34
Notes	34
Embedders and Disembedders	34
Product Limitations	35
Architectural Defects	35
3 NV9000 Web Suite	37
Summary	37
DHP Pages	39
Example	39
DHP Disembedder	40
DHP Embedder	41
DHP Re-Entry	42
DHP Drawing	42
Signal Paths	43
Usage	44
Preferences	45
Sample NV9000 Data	46
Non-Core Ports	46
Input	46
Output	46
DHP Core Ports	46
Re-embedders tied to Standard Inputs	46
Disembedders tied to Standard Outputs	47
4 Misc. Topics	49
Parts	49
I/O Cards	49
I/O Backplane Connector Modules	50
Slot Numbers	51
NV8144, NV8140, or NV8280	51
NV8576	52
NV8576-Plus	52
Index	53
Contact Us	57

1 Introduction

Chapter 1 provides a brief introduction to DHP and the NV8500.

Topics

<i>NV8500 Review</i>	1
<i>DHP Summary</i>	4

NV8500 Review

You may safely skip this section if you are familiar with the NV8500 routers.

The NV8500 family of routers comprises 4 routers:

- NV8144— 8RU, 144×144 video matrix
- NV8140— 8RU, 144×288 video matrix
- NV8280— 16RU, 288×576 video matrix
- NV8576— 32RU, 576×1152 video matrix
- Stand-alone NV8576-Plus— 32RU, 576×576 video matrix
- Expanded NV8576-Plus— Two 32RU frames, interconnected, 1152×1152 video matrix

The routers in the NV8500 family switch both video (SD, HD, 3Gig), and audio (AES sync and async). The routers support two classes of input and output cards:

- 1 Standard— video (SD, HD, 3Gig rates automatically detected), or AES (async).
(The NV8140 does not support AES async at this time.)
- 2 Hybrid— combining audio with video (SD, HD, 3Gig).

There are *disembedder* cards (that extract audio from video input).

There are *embedder* cards (that insert audio into video output).

There are MAD1¹ input and output cards. MAD1 input cards have 8 video inputs and one MAD1 input. MAD1 output cards have 16 video outputs and two MAD1 outputs. For the NV8576-Plus, there are expansion output cards that have 8 video outputs and one MAD1 outputs.

If **any** hybrid I/O cards are present, the router is considered a hybrid router. **All** its control cards and all its crosspoint cards must be hybrid cards. Otherwise, you can consider the router a standard router and all its control cards and crosspoint cards can be standard cards.

You can have a combination of the card types in your router. *Standard* input cards do not disembed audio; *standard* output cards do not re-embed audio. With the *hybrid* cards, the

1. MAD1 (multi-channel audio digital interface) is time-multiplexed AES. The NV8500 supports 64-channel and 56-channel MAD1. A DIP switch configures a MAD1 output card for 56-channel mode. MAD1 input cards accept any number of channels (up to 64).

routers can disembed audio, recombine the audio, and re-embed the recombined audio at output.

With DHP (dynamic hybrid pathfinding), the routers can route standard input through an internal pool of hybrid disembedder cards and embedder cards after which the audio from the standard input can be recombined and re-embedded on output. The point of DHP is that it allows you to populate the router with many relatively inexpensive standard I/O cards and a few hybrid cards and still have the benefits of hybrid routing (the ability to breakaway audio entirely within the router).

I/O Cards

Each router has a certain number of input card slots and a certain number of output card slots:

Router	Input Slots	Output Slots	Nominal Video Matrix Size
NV8144	16	8	144x144
NV8140	8	16	144x288
NV8280	32	32	288x576
NV8576	64	64	576x1152
NV8576-Plus (stand-alone)	128	128	576x576
NV8576-Plus (expanded)	128	128	1152x1152

You may populate the slots with any type of input or output card your system requires.

Input cards are coupled with input backplane connector modules (or backplanes, for brevity). Output cards are coupled with output backplanes. Backplanes typically have coax (DIN 1.0/2.3) connectors or fiber optic (SFP) connectors. (Balanced AES modules use WECO quick-release connectors.):

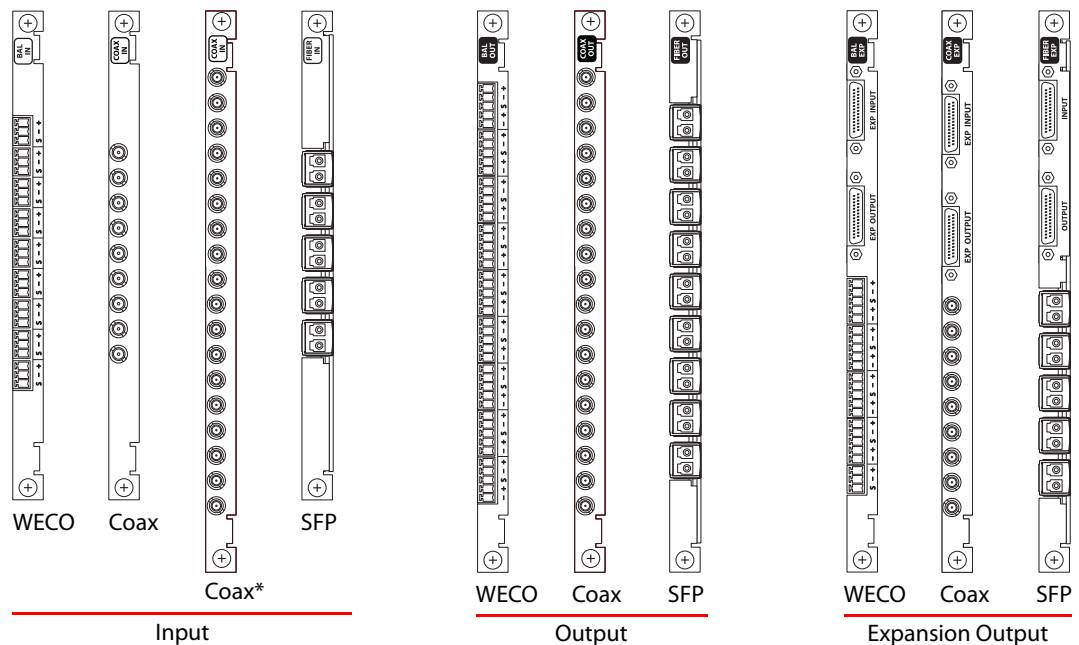

For routers other than the NV8140, input backplane modules each have 9 connectors. Output backplane modules each have 18 connectors. Expansion output backplane modules (only for the NV8576-Plus) have 9 connectors and two 28-pin expansion ports.

For the NV8140, input backplanes for the NV8140 have 18 connectors.

Standard Cards

Standard input cards use all 9 connectors of the backplane modules. Standard output cards use all 18 connectors of the backplane modules.

Disembedder and Embedder Cards

For routers other than the NV8140, hybrid disembedder (input) cards use 8 of the 9 connectors. The 9th connector is not used. Hybrid embedder (output) cards use 16 of the 18 connectors. The 9th and 18th connectors are not used.

For the NV8140, hybrid disembedder (input) cards use 16 of their 18 connectors. The 9th and 18th connectors are not used.

Hybrid expansion embedder (output) cards use 8 of the 9 connectors.

There are no video ports or audio ports associated with the unused connectors.

MADI Cards

(MADI cards are also known as 3Gig/TDM cards.)

For routers other than the NV8140, hybrid MADI input cards use the first 8 connectors for video input and use the 9th connector for MADI input (up to 64 channels). Hybrid MADI output cards use connectors 1–8 and 10–17 for video output and use the 9th and 18th connectors for MADI output (56 or 64 channels each).

These MADI input cards have 64 audio ports. The remaining 80 ports of the card's port space are unused.

For the NV8140, hybrid MADI input cards use connectors 1–8 and 10–17 for video input and use the 9th and 18th connectors for MADI input (up to 64 channels each).

These MADI input cards have 128 audio ports. The remaining 160 ports of the card's port space are unused.

Hybrid MADI output cards use connectors 1–8 and 10–17 for video output and use the 9th and 18th connectors for MADI output (56 or 64 channels each).

Hybrid expansion MADI output cards use the first 8 connectors for video output and use the 9th connector for MADI output (56 or 64 channels).

MADI output cards have 128 audio ports. The remaining 160 ports of the card's port space are unused.

Expansion Cabling for the NV8576-Plus

The expanded NV8576-Plus router comprises two interconnected router frames. The frames use *expansion cards and expansion backplane modules*. Expansion output backplanes have 9 connectors and two 28-pin expansion connectors. Cables connect the 2 router frames on the expansion connectors.

Expansion *output* cards provide 9 outputs. Expansion output backplanes have 9 connectors and two 28-pin expansion connectors. Expansion *filler* cards provide **no** outputs, but support the expansion connections. Cables connect the 2 router frames on the expansion connectors.

DHP Summary

DHP (dynamic hybrid pathfinding) allows the NV8500 router to perform hybrid routing with relatively few hybrid cards. With DHP, the router passes standard inputs through an internal pool of hybrid disembedder cards and embedder cards after which the audio from the standard inputs can be recombined and re-embedded on output.

The point of DHP is that it allows you to populate the router with many relatively inexpensive standard I/O cards and a few hybrid cards and still have the benefits of hybrid routing (that is, to allow audio from standard inputs to be disembedded and re-embedded for standard outputs, all within the router).

DHP is a service that resides in the NV9000. The NV9000 control software treats the DHP service as if it were a hybrid router.

NV9000

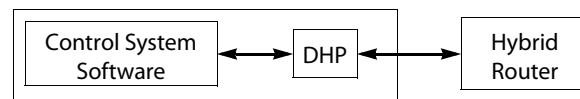

The DHP service then communicates with the router directly. All takes to a hybrid router go through the DHP service, transparently. All status from the router also goes through the DHP service.

DHP is licensed software (EC9540) that ships with the NV9000. The purchase of the license allows you to activate the DHP service in the NV9000. See [Activation](#) on page 7.

- ▲ If you have an older version of the NV9000 software that does not include DHP, you will need to obtain an updated version of the NV9000 software.

Figure 1-1 shows a fairly typical route using DHP:

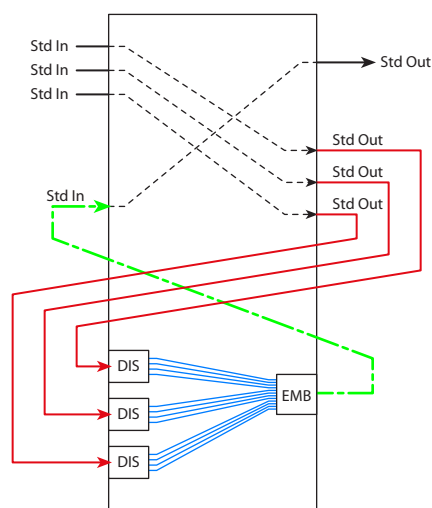

This scenario combines audio from 3 separate standard inputs and routes the video from one of the inputs with the combined audio on a standard output.

A disembedder port is required for each standard input port from which audio is to be extracted. An embedder port is required for the output that is to receive the recombined audio.

Further, an *additional* standard output port is required for each standard input port from which audio is to be extracted. An *additional* standard input port is also required for the output that is to receive the recombined audio.

The DHP service routes the signals through a pool of available hybrid cards internally. External cabling is required for every DHP path.

Fig. 1-1: DHP Scenario — Recombining Audio from Standard Input

This is only one of a few dozen DHP scenarios. Other scenarios involve MAD1 inputs and outputs and AES inputs and outputs. See [Examples](#) on page 24 for a discussion of DHP scenarios.

Preliminary DHP Analysis

In the analysis of your system, you should determine the number of inputs and outputs of each type:

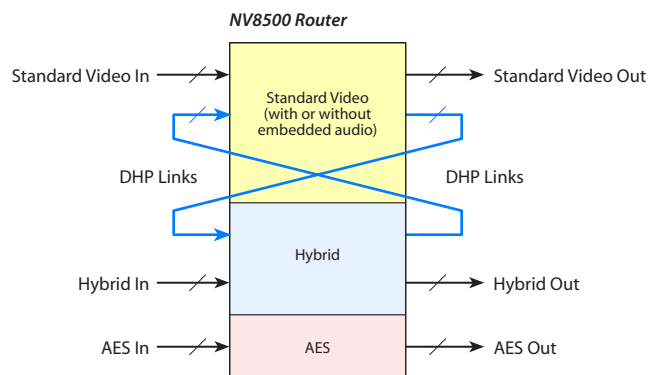

External cabling is required for every DHP path.

Fig. 1-2: DHP Links

This evaluation includes the number of standard inputs and standard outputs, the number of hybrid inputs and outputs, and the number of AES inputs and outputs.

If your router is to perform DHP, you will also need the size of the DHP pool (or DHP “core”), i.e., the number of DHP links required by your router. This number might be difficult to determine. Keep in mind that the DHP links are dedicated disembedders and re-embedders and are not to be considered inputs and outputs. There are several factors to consider.

These are two of the factors:

- 1 The number of DHP paths that can be in use simultaneously.
- 2 The number of ports required for each path.

As stated earlier, and illustrated in Figure 1-1, a certain number of *hybrid* ports and a certain number of *additional standard* ports are required for each DHP path.

Potentially, 16 sources could each provide a single audio channel to an output. This would be considered an extreme and unusual case. If all 16 audio channels come from a single source, DHP is not used for that route. Thus, the minimum number of sources for DHP is 2 and the maximum is 16. The number of destinations for DHP is always 1.

You need to determine the average number of ports among all the DHP paths in use simultaneously. The average is, of course, somewhere between 2 and 16, probably very close to 2.

Thus, letting ‘A’ be the average number of sources, and ‘N’ be the number of simultaneous DHP paths,

$$\text{Disembedder ports} = A \times N$$

$$\text{Embedder ports} = N$$

$$\text{Additional standard input ports} = N$$

$$\text{Additional standard output ports} = A \times N$$

Note that DHP is used for disembedding and re-embedding audio. Therefore the hybrid cards that constitute the DHP core must be one of these:

8500H-IP-3G-DEM-CX	(disembedding, input)
8500H-OP-3G-EMB-CX	(embedding, output)
8500H-OPX-3G-EMB-CX	(embedding, expansion output)

[There are no fiber-optic hybrid cards at this time.]

Note: ports belonging to the DHP core cannot be used as routable inputs or outputs. Panel operators cannot route to them or from them directly.

Other DHP Considerations

Tielines

The NV8500 router that DHP is servicing might involve some tielines. You must identify the inputs and outputs of all tielines in a DHP configuration (initialization) file.

Force Embedder Off

The DHP configuration allows you to specify, for some inputs, that when they are routed to embedder outputs, the embedder is **forced off** (i.e, the embedder is bypassed). In such a case, the audio from the input is kept intact and passed through the output without change. This option is controlled by "EO" commands in DHP's port configuration files.

It might be a point of confusion that, in MRC, there is just the opposite function: some inputs in the router are configured to force any embedding output to use its embedder, rather than let the router follow switching rules to determine the embedder state.

If your router uses DHP, it is imperative that you **do not** ever use the "force embedder ON" function in MRC.

ASI Signals

You must identify ASI inputs and ASI outputs in a DHP initialization file.

See ['HybridPorts' Files](#) on page 16 for detail.

DHP Service

2

Chapter 2 provides detailed information about DHP.

Topics

<i>Activation</i>	7
<i>Definitions</i>	8
<i>Configuration</i>	9
<i>Configuration Process</i>	10
<i>DHP Features</i>	23
<i>Examples</i>	24
<i>Notes</i>	34

Activation

DHP is licensed software (EC9540) that ships with the NV9000. The purchase of the license allows you to activate the DHP service in the NV9000.

Follow these steps to activate the DHP service:

- 1 Obtain the NV9000 Control System CD from Miranda (GVD). This CD contains one or more activation programs depending on which licenses you have purchased.
- 2 Copy the DHP activation file (presently SV1062-01.exe) from the CD to a USB drive.
- 3 Connect a keyboard, mouse, and monitor to the NV9000 frame.
- 4 Login to the NV9000. The default username is `envyadmin` and the default password is `software`.
- 5 Insert the USB drive into a free USB slot of the NV9000.
- 6 When the USB drive window appears, double-click the DHP activation file. The activation program takes no more than a second to finish.
- 7 Remove the USB drive from the NV9000.
 - ▲ It might be convenient to activate all the services you have purchased at this time, if you have purchased more than one. Just copy all your service activation programs to the USB drive and run each one individually on the NV9000.
 - ▲ If you have an older version of the NV9000 software that does not include DHP, you will need to obtain an updated version of the NV9000 software.

Repeat the activation process for each NV9000 that is to use DHP.

(You will have to log in again later to install the DHP configuration files. See [Initialization—the Configuration Files](#) on page 13)

Definitions

Standard card	Standard input or output card. Standard input or output is video (3Gig, HD, or SD) with or without embedded audio. No disembedding or embedding occurs. Using standard cards only, the signal passes unchanged. through the router.
Standard input card	8500-3GIG-IN-COAX 8500-HD-IN-COAX 8144-3GIG-IN-COAX 8144-HD-IN-COAX 8500-3GIG-IN-FIBER
Standard output card	8500-3GIG-OUT-COAX 8500-3GIG-OUT-COAX-EXP (for expanded routers) 8500-HD-OUT-COAX 8500-HD-OUT-COAX-EXP (for expanded routers) 8144-3GIG-OUT-COAX 8144-HD-OUT-COAX 8500-3GIG-IN-FIBER 8500-3GIG-OUT-FIBER 8500-3GIG-OUT-FIBER-EXP (for expanded routers)
Hybrid cards	Hybrid cards are those that receive or transmit both video and audio signals.
MADI card ¹	MADI input or output card. The MADI ports support 64 TDM audio channels at 48.000 kHz. (The input cards and the expansion output card have 8 ports of standard video and one MADI input port). The MADI output card has 16 video ports and 2 MADI ports.
MADI input card	8500H-IP-TDM-CX
MADI output card	8500H-OP-3G-TDM-CX 8500H-OPX-3G-TDM-CX (for expanded routers)
Disembedder card	8500H-IP-3G-DEM-CX
Embedder card	8500H-OP-3G-EMB-CX 8500H-OPX-3G-EMB-CX (for expanded routers)
Well-known ports	A list of Ethernet port numbers that are used globally and are registered with the IANA (Internet Assigned Numbers Authority) http://www.iana.org/assignments/port-numbers
Audio shuffling	The concept of recombining audio from several inputs and embedding it in one (or more) outputs.
Force embedder off	Under normal circumstances, the embedder of a router output is enabled or disabled automatically according to internal switching rules. It is possible in DHP for router inputs to be configured so that they force the embedder to be bypassed.

1. MADI input rates (and number of channels) are determined by the actual MADI input stream. The MADI output rate is exactly 48.0 kHz (samples per second). MADI output supports either 56 or 64 channels, according to a DIP switch setting.

Tieline	A connection between the output of one router and the input of another router (or possibly of the same router). A <i>multi-hop</i> tieline is one that involves connections among more than two routers.
---------	--

Configuration

As a service, DHP interprets take commands from the NV9000 and calculates routes that require disembedded and re-embedded audio, and relays appropriate commands to the router. DHP manages a pool of DHP ports that we call the *DHP core*. DHP also determines whether the route requires use of the DHP core. A case where it does **not** require the core is a take from a standard input to a standard output.

There are several steps in configuring DHP. These involve MRC, NV9000-SE Utilities (and your NV9000 configuration) and DHP configuration files.

The order in which you perform the configuration steps is not critical as long as you perform all the configuration tasks and have valid DHP configuration files installed before you restart your NV9000 with DHP active.

There is no feedback that can tell you whether DHP is active and running properly, except that DHP will not work if you have, for example, an improper DHP configuration file.

If you are using the NV9000 Web Suite to monitor DHP, and DHP is not operating, the DHP pages will “freeze” and display stale data. The web suite has no failure report.

Warnings

If you are adding DHP to an existing router, **save your existing configuration** before doing so. If you ever decide to stop using DHP, your router will need a non-DHP configuration to operate.

Do not restart your NV9000 without correct DHP configuration files. DHP might fail to start if it detects errors in its configuration files.

Assumptions made here: your NV9000 is configured and is communicating with the router that is to use DHP. This document does not address NV9000 configuration apart from the requirements for DHP.

Summary

This is a summary of the DHP configuration steps. Details follow.

- 1 Following your DHP analysis, populate the router with cards belonging to the DHP core.
Make notes about what you have done.
- 2 In MRC, define or redefine router partitions for the router.
- 3 In MRC, specify or re-specify the card types for all slots of the router.
- 4 In MRC, ensure that **no** router input has its “force embedder on” attribute set true.
- 5 In NV9000-SE Utilities
 - a Make the NV9000 communicate with DHP (instead of the router)
 - b Make DHP communicate with the router’s control card(s).
- 6 In NotePad or a similar tool, write the DHP configuration files. Verify that they are correct and save them in the folder C:\nvision of the NV9000 system controller(s).

- 7 In NV9000-SE Utilities
 - a Ensure that a level set exists that includes all audio levels in use.
 - b Explicitly define all audio levels for standard inputs and outputs that can be switched using DHP. [For standard I/O that will never be switched by DHP, this is not necessary.]
- 8 In NV9000-SE Utilities, if your router has MAD1 ports
 - a Add 40,000 to any and all MAD1 port numbers. (DHP requires this.)
 - b Add 40,000 to the audio matrix size.
- 9 In NV9000-SE Utilities, clear the DHP portion of the router's crosspoint matrix.
- 10 Remove any previously defined sources and destinations from the DHP core portion of the NV9000 configuration.
- 11 Finally, write the new configuration to the NV9000 and restart the NV9000. Then set the DHP service to "automatic" and start the DHP service.

Configuration Process

[1] DHP Core

In your analysis of the DHP requirements of your router, you will have determined the number and type of hybrid cards to include in the DHP core.

If you are adding DHP to an existing router, place the disembedder (input) cards and embedder (output) cards that form the DHP core in the router. Also place the cards' matching backplane connector modules. The cards in the DHP core do not have to be contiguous.

If you are starting with a new unconfigured router, it is probable that the cards belonging to your DHP core have been installed at the factory.

In either case, make sure that the cards and backplane modules are installed properly and make careful written notes about which slots you have used for the DHP core. The port numbers for the cards in those slots are critical to the configuration process.

[2] Router Levels

DHP requires that your router have exactly one 'Digital Video' partition and one 'Synchronous Audio' partition. Partitions of other types are acceptable, such as a monitor partition. Use the 'Router Levels' page in MRC to define the partitions. This example is typical for an NV8280:

Level	Physical Input Start	Physical Input End	Controller Source Start	Controller Source End	Physical Output Start	Physical Output End	Controller Destination Start	Controller Destination End	Signal Type
1	1	288	1	288	1	576	1	576	Digital Video
2	1	4608	1	4608	1	9216	1	9216	Synchronous Audio

Buttons: Update Control Card, Add Level, Delete Level...

Fig. 2-1: Router Partitions for an NV8280 Using DHP

[3] NV9000-SE Configuration

If you are adding DHP to a router, you will have to change your NV9000-SE Utilities settings to conform to what is discussed here.

DHP stands between the NV9000 control process and the router. The control process communicates with DHP as if it were the router. Therefore, in NV9000-SE Utilities, you must specify the IP address of the router as 127.0.0.1 (which is, in a sense, the address of DHP). If you are creating a new router definition, you will see a page similar to this:

Fig. 2-2: Router Details (NV8280 Shown)

Note: if your router has MADI cards, add 40,000 to the audio level size (i.e., to the 'Input End' field and the 'Output End' field).

(This IP address is called a "loopback address.")

Note that NV9000-SE Utilities will give you a warning message, because, under normal circumstances, 127.0.0.1 is an unusable address:

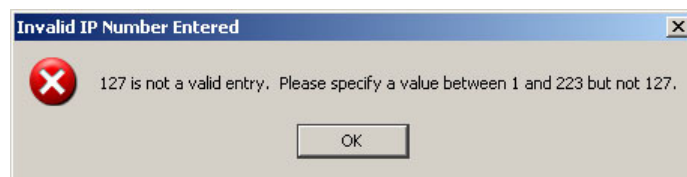

You can ignore this message, because the use of DHP is an exceptional circumstance.

Then, in the 'Control Points' table (under the 'Views' navigation pane), change the description field for the DHP proxy of the router: This is a sample control point table (for an NV8280):

Control Points Table ✕

Computer Name Filter:

ID	Computer Name	Parameters	Description
5	NVCONFIG	S,7,38400,N81	COM9 P4 NVCONFIG
6	NVCONFIG	S,8,38400,N81	COM10 P5 NVCONFIG
7	NVCONFIG	S,9,38400,N81	COM11 P6 NVCONFIG
8	NVCONFIG	S,10,38400,N81	COM12 P7 NVCONFIG
9	NVCONFIG	E,127.0.0.1	DHP Service for Primary Control Card
10	NVCONFIG	E,127.0.0.1	DHP Service for Secondary Control Card

Add Delete

Revert to Saved Save ?

Changing the description is not actually necessary, but very helpful.

If you are modifying an existing router definition, it is here that you would change its IP address to 127.0.0.1.

Then, update the parameters fields in the 'Router Controls' table:

Router Controls Table ✕

Router Filter: ControlPoint Filter:

	Router Name*	Control Point Description*	Protocol*	Parameters	Control Mode*
1	NV8280	DHP Service for Primary Control Card, ID: 9	NV Ethernet	E,192.168.1.9	Primary control card
2	NV8280	DHP Service for Secondary Control Card, ID: 10	NV Ethernet	E,192.168.1.10	Secondary control card

* Required column.

Revert to Saved Save ?

Define the parameters field as "E", comma, and the IP address of the router control card. Doing that lets the DHP service know the IP address of the router control card with which it is to communicate.

(If you are modifying an existing router definition, the values you enter in the parameters field here are what were in the parameters field of the control points table. These IP addresses will have been initially defined in MRC.)

When there are two control cards, one primary and one secondary, only one of those control cards is actively running. The other control card is in stand-by mode.

Similarly, when there are two control cards, the NV9000 will launch two DHP services at startup. One of the DHP services is active and the other is stand-by (running, but idle).

At this stage, the 'Control Points' table is not quite finished—you must specify the DHP ports.

DHP Ports

The DHP service relies on configuration parameters to build its internal view of the router correctly and to act as an address translator between the control system and the actual router.

You must specify two items in the 'Control Points' table of NV9000-SE Utilities:

- The IP address of the DHP service. As stated previously, that is always 127.0.0.1.
- Each DHP control point needs its own port. This is designated by 'HR: <port>' in the 'Control Points' table entry. You may select a port from a range of unassigned "well known ports":²

9451–9499

9630–9699

9701–9746

9803–9874

If the router has primary and secondary cards, the 'Control Points' table will have two entries. Append the port values to the control point parameters field(s). The entries will resemble these:

ID	Computer Name	Parameters	Description
9	NVCONFIG	E,127.0.0.1,HR:9476	DHP Service for Primary Control Card
10	NVCONFIG	E,127.0.0.1,HR:9477	DHP Service for Secondary Control Card

The DHP service also needs the IP addresses of the control cards with which it is communicating. These were specified in NV9000-SE Utilities' 'Router Controls' table:

Router Name*	Control Point Description*	Protocol*	Parameters	Control Mode*
NV8280	DHP Service for Primary Control Card, ID: 9	NV Ethernet	E,192.168.1.9,FS:143	Primary control card
NV8280	DHP Service for Secondary Control Card, ID: 10	NV Ethernet	E,192.168.1.10,FS:143	Secondary control card

At the end of the 'Parameters' field for each control point, specify the *free source* that DHP will use to free DHP ports. The free source is one of the router's video ports and it must be a disembedding port. The syntax of the free source specification is

,FS:<port number>

Note that the DHP configuration files also use the well-known port numbers in their names.

[4] Initialization—the Configuration Files

When the NV9000 starts up, this service creates internal maps based on configuration parameters from the NV9000 database, configuration files, and the hybrid router. This information is combined to build a very accurate internal model of the router for the purposes of managing its ports and channels.

After building its internal data structures, the DHP service opens a communication port with the hybrid router and waits for the NV9000 to contact it. From the NV9000's standpoint, the DHP service *is* the hybrid router.

The service **must** distinguish which cards are standard cards, which cards are disembedder or embedder cards, and which cards are MADI cards, and must know their locations within the frame. You must make this information available in initialization files. Place the initialization files in the folder C:\nv\i s i o n of the NV9000.

There are sample initialization files in that folder.

2. See www.iana.org/assignments/port-numbers

There are two different initialization files needed for the DHP service to operate.

- HybridCards_XXXX.cfg
- HybridPorts_XXXX.cfg

where XXXX is a “well-known port” for this router that you specified earlier in the NV9000’s ‘Control Points’ table.

- ▲ You must have one copy of these files for each port used. For instance, if you use ports 9476 and 9477, you will need 4 initialization files: HybridCards_9476.cfg, HybridCards_9477.cfg, HybridPorts_9476.cfg, HybridPorts_9477.cfg.

As a reminder, these are the unassigned “well known ports”:

9451–9499 9630–9699 9701–9746 9803–9874

The HybridCards_XXXX.cfg file lets the software know what cards are located in the slots of the hybrid router frame(s). The file contains commands that identify the type of card in specific slots. The file allows one command per line. The commands are very simple.

The HybridPorts_XXXX.cfg file tells DHP the locations of the designated *pairs* of disembedder ports and *pairs* of re-embedder ports. (The DHP service to be configured on a port-by-port basis.) The ports you list in the file belong to the “DHP core.”

‘HybridCards’ Files

A ‘HybridCards’ file tells DHP what types of cards are in which slots. This is the same information you specified in MRC in step 2-1. This information, however, resides in the NV9000 instead of the router control card.

There are 4 commands that you can write in the file.

F <frame type>	Acceptable ³ values for <frame type> are 8144 — NV8144 8280 — NV8280 8576 — NV8576 8577 — NV8576-Plus
S <section>	Acceptable values for <section> are IN or OUT.
C <slot> <type>	Acceptable values for <type> are Ø — standard card 1 — MADI card 2 — reserved for future use 3 — disembedder or embedder card Slot numbers must be in the range supported by the router.
END	Indicates the end of a section.

- ▲ Note: The numbers representing card types in a ‘HybridCards’ file do not necessarily match the numbering schemes for other software.

An F command must precede S or C commands.

An S command must precede C (card type) commands. Otherwise, DHP will not know whether the cards defined are input cards or output cards. An END command *must* follow the last C command of a section.

3. DHP does not (yet) support the NV8140. You cannot choose an NV8140 in the configuration file.

You can also think of the commands as hierarchical: A frame (F) contains sections (S) and sections contain cards (C).

The following is a small and simple example:

```
F 8144
S IN
C 1 0
C 2 0
C 3 3
C 4 1
END
S OUT
C 1 0
C 2 0
C 3 3
C 4 1
END
```

This example describes 4 input cards (in slots 1–4) and 4 output cards (in slots 1–4) in an NV8144. In the example, the cards in the first two *input* slots are standard cards. The third input slot has a disembedder card and the fourth input slot contains a MAD I card.

Similarly, the cards in the first two *output* slots are standard cards. The third input slot has an embedder card and the fourth output slot contains a MAD I card.

Actual configuration files, of course, would be larger than this example, but just as simple.

- ▲ If an NV8576-Plus has two frames, its configuration file(s) have 4 sections in order:

```
; Frame 1
F 8577
S IN
  cards
END
S OUT
  cards
END
;Frame 2
F 8577
S IN
  cards
END
S OUT
  cards
END
```

You **must** specify the cards in ascending order of the slots.

- ▲ Important: the slot ordering follows the slot labeling on the rear of the router, although some older routers might have different labels. See [Slot Numbers](#) on page 51.
- ▲ Note that if DHP does not recognize the content of a line in the file, the line is treated as a comment. You are free to intersperse comments throughout the configuration file. Comments typically start with a semicolon (;) or an asterisk (*).

'HybridPorts' Files

The 'HybridPorts' files serves 3 purposes:

- It identifies the ports that form the core and their connections.
There are IN and OUT commands for the core ports.
- It identifies the ports that have certain attributes that affect DHP.

These attributes are

- Input ports that have the "force embedder" attribute (EO command).
- Output ports for which DHP emits video only (VO command).
- Input and output ports that belong to tielines (TL command).

The commands that specify these attributes (EO, VO, and TL) must appear in the HybridPorts file *after* the core commands.

- It specified the maximum number of embedded audio channels in NV8500 router inputs.
Use the CHANNELS command. (The CHANNELS command can appear anywhere in the file.)

You can refer to the sample initialization files (located in the C:\nvision of the NV9000 system controller in which DHP resides) for further information.

Core Ports

There are two kinds of commands that you can (and must) write in the file.

```
IN <port-A> <type> <port-B>
```

```
OUT <port-B> <type> <port-A>
```

These commands must be paired. Port-A must be identical in both commands of the pair and port-B must be identical in both commands of the pair. If there is a mismatch, DHP will return an error report in its log file:

```
C:\nvision\envy\userlocal\logs\HybridSVC.log
```

If the error is severe, the DHP service will not run.

The ports are video port numbers in the range supported by the router. Please refer to the port enumeration drawings, RF0272 through RF0276.

The recognized values for <type> are

- 1— re-embedder
- 2— disembedder

An example:

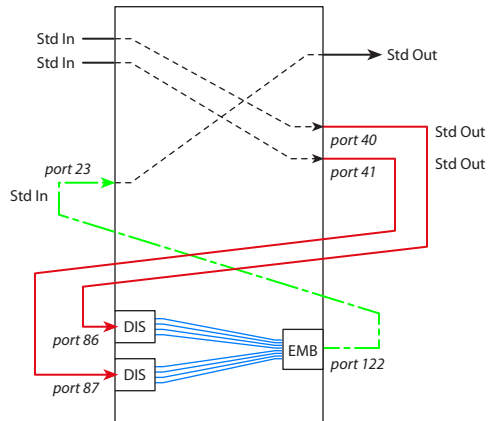

This illustration shows

- a One re-embedder path (green, dashed).

Each re-embedder pair describes a hybrid embedder card “tied to” a standard input card. The single path in the example requires two commands in the file:

```
OUT 122 1 23    Port 122 (hybrid out) is tied to port 23 (std in).
IN  23 1 122   "1" means a re-embedder connection.
```

- b Two disembedder paths (red, solid).

Each disembedder pair describes a standard output port “tied to” a hybrid disembedder input card. This example has two disembedder paths, requiring 4 commands in the file:

```
OUT 40 2 86    Port 40 (std out) is tied to port 86 (hybrid in).
IN  86 2 40    "2" means a disembedder connection.
OUT 41 2 87    Port 41 (std out) is tied to port 87 (hybrid in).
IN  87 2 41
```

- ▲ In general, there will be more disembedder paths than re-embedder paths.
- ▲ The order in which you write the commands does not matter as long as the pairs exist. You could group all the OUT commands together and all the IN commands together if it suits your purpose.
- ▲ Note that if DHP does not recognize the content of a line in the file, the line is treated as a comment. You are free to intersperse comments throughout the configuration file. We suggest you use comments that start with a semicolon (;).

CHANNELS Command

The syntax for the “Channels” command is

```
CHANNELS <number>           where 1 ≤ <number> ≤ 16
```

Use this command at the beginning of the ‘HybridPorts’ file to specify the maximum number of audio channels embedded in the signals your router receives.

Caution: embedder outputs always embed 16 audio channels. If your input signal has fewer than 16 channels, you will almost certainly want to provide generated silence for the remaining channels at output.

Specifying a channels value allows your NV9000-SE configuration to specify only those channels that are needed and lets DHP ignore the unspecified channels.

EO Command

This is the “Embedder Off” command. Its syntax is

```
EO IN <input-port>
```

Use this command to specify that for an input port, the output embedder is bypassed.

Caution: MRC lets you set a “force embedder ON” flag for any router input. For routers using DHP, all inputs should have this attribute turned off.

Note that the sense of the EO command in DHP (force embedder off) is the opposite of the sense in MRC (force embedder on).

For any ASI input ports, issue the EO command for the port in the HybridPorts file.

VO Command

This is the “Video Only” command. Its syntax is

```
VO OUT <output-port>
```

Use this command to specify that an *output* port does not embed any audio from the router’s audio crosspoint matrix, but emits only video (with its own embedded audio if it had any).

For any ASI output ports, issue the VO command for the port in the HybridPorts file.

TL command

This is the “Tieline” command. Its syntax is

```
TL <port-type> <port> where <port-type> is IN or OUT
```

Use this command to specify that a port (an input or an *output*) belongs to a tieline.

Software Interface

The DHP service communicates with the hybrid router (over Ethernet) using the NVISION Router Protocol, also known as protocol C. Its message syntax can be found in Grass Valley’s NP0016-00 protocol document.

The DHP service communicates with the NV9000 using NV9000 Ethernet Control Protocol, also known as protocol E. Its message syntax can be found in the NP0017-00 document.

All this is internal to the NV9000 and not germane to configuration or operation.

Note that no special cabling is required.

More in NV9000-SE Utilities

Whether you are adding DHP to an existing system or you are creating a new system that has DHP, you should observe these points in your NV9000 configuration.

[5] **Audio for Standard Inputs and Outputs**

You must explicitly specify the audio levels for each standard input and for each standard output. Each standard video input can have up to 16 embedded audio channels. The same is true for standard video output.

Define a level set that includes as many audio levels as you need. This is a typical example:

Level Set Details Table x

LevelSet Filter:	VirtualLevel Filter:	PhysLevel Filter:
All		

	Level Set*	Virtual Level*	Physical Level*	Index*	Free Source
1	All Levels	HD	NV8280_V	1	
2	All Levels	AUDIO 1	NV8280_A	2	
3	All Levels	AUDIO 2	NV8280_A	3	
4	All Levels	AUDIO 3	NV8280_A	4	
5	All Levels	AUDIO 4	NV8280_A	5	
6	All Levels	AUDIO 5	NV8280_A	6	
7	All Levels	AUDIO 6	NV8280_A	7	
8	All Levels	AUDIO 7	NV8280_A	8	
9	All Levels	AUDIO 8	NV8280_A	9	
10	All Levels	AUDIO 9	NV8280_A	10	
11	All Levels	AUDIO 10	NV8280_A	11	
12	All Levels	AUDIO 11	NV8280_A	12	
13	All Levels	AUDIO 12	NV8280_A	13	
14	All Levels	AUDIO 13	NV8280_A	14	
15	All Levels	AUDIO 14	NV8280_A	15	
16	All Levels	AUDIO 15	NV8280_A	16	
17	All Levels	AUDIO 16	NV8280_A	17	
18	All Levels	RS422	NV5256	18	

Add Delete

* Required column.

Revert to Saved Save ?

Typically, this level set would be the same level set you use for hybrid inputs and outputs.

[6] **MADI Port Numbering**

For a router that has DHP and MADI cards, you must add 40,000 to all MADI port numbers. Further, you must add 40,000 to the size of the router's audio matrix. You must do this in NV9000-SE Utilities, but *not* in MRC.

Go to the router's detail page to change the audio matrix size. Here is the an example for an NV8280:

Name	#	Input Start	Input End	Output Start	Output End
NV8280_V	1	1	288	1	576
NV8280_A	2	1	44608	1	49216

The audio matrix here was 4608 × 9216, and still is in reality.

- ▲ Adding 40,000 in NV9000-SE Utilities does not change the port numbers themselves. It just allows the MADl ports to be managed with all the non-MADl audio ports. In the example above, the matrix is still 4608 × 9216.
- ▲ Although the actual matrix is still moderate in size, NV9000-SE Utilities does in fact operate as if the matrix were 44,608 × 49,216. The result is a massive performance degradation. Fortunately, NV9000-SE Utilities is in use only for configuration and diagnostics. Neither the NV9000 itself nor DHP suffers any performance degradation.

Requirements for Adding DHP to a Router

If you are creating a new DHP router and not modifying an existing router, you may skip steps 7 and 8.

[7] Clear the Crosspoint Matrices

If you are adding DHP to a hybrid router, it is important to ensure that all inputs of the proposed DHP core, for either core embedders or core disembedders, have all destinations cleared. To do that, route another source, that is not part of the DHP core, to every destination port currently using a source from the proposed DHP core inputs. If you fail to do this, the functionality of DHP will be compromised and its resulting behavior will be unpredictable.

Use the 'Crosspoints' page of MRC to perform the needed routes: This is a sample of the page:

The screenshot shows the 'Crosspoints' configuration window. It has three tabs: 'Current', 'History', and 'Incrementing Takes'. The 'Current' tab is active, displaying a table with the following columns: Destination, Source, Locked, Protected, LID, and Status. The table contains 25 rows of data, all with Source set to 1 and LID set to 0. Below the table are controls for Output Filter (Min: , Max: , Clear), Level (1) Digital Video, and Tools (Refresh, Save, Print, etc.).

Destination	Source	Locked	Protected	LID	Status
538	1	<input type="checkbox"/>	<input type="checkbox"/>	0	
539	1	<input type="checkbox"/>	<input type="checkbox"/>	0	
540	1	<input type="checkbox"/>	<input type="checkbox"/>	0	
541	1	<input type="checkbox"/>	<input type="checkbox"/>	0	
542	1	<input type="checkbox"/>	<input type="checkbox"/>	0	
543	1	<input type="checkbox"/>	<input type="checkbox"/>	0	
544	1	<input type="checkbox"/>	<input type="checkbox"/>	0	
545	1	<input type="checkbox"/>	<input type="checkbox"/>	0	
546	1	<input type="checkbox"/>	<input type="checkbox"/>	0	
547	1	<input type="checkbox"/>	<input type="checkbox"/>	0	
548	1	<input type="checkbox"/>	<input type="checkbox"/>	0	
549	1	<input type="checkbox"/>	<input type="checkbox"/>	0	
550	1	<input type="checkbox"/>	<input type="checkbox"/>	0	
551	1	<input type="checkbox"/>	<input type="checkbox"/>	0	
552	1	<input type="checkbox"/>	<input type="checkbox"/>	0	
553	1	<input type="checkbox"/>	<input type="checkbox"/>	0	
554	1	<input type="checkbox"/>	<input type="checkbox"/>	0	
555	1	<input type="checkbox"/>	<input type="checkbox"/>	0	
556	1	<input type="checkbox"/>	<input type="checkbox"/>	0	
557	1	<input type="checkbox"/>	<input type="checkbox"/>	0	
558	1	<input type="checkbox"/>	<input type="checkbox"/>	0	
559	1	<input type="checkbox"/>	<input type="checkbox"/>	0	
560	1	<input type="checkbox"/>	<input type="checkbox"/>	0	
561	1	<input type="checkbox"/>	<input type="checkbox"/>	0	
562	1	<input type="checkbox"/>	<input type="checkbox"/>	0	

[8] NV9000 Configuration

If you are adding DHP to a hybrid router, your existing configuration might have sources and destinations occupying positions that will be used by the proposed DHP core.

You should remove or relocate those sources and destinations—or revise the proposed core—so that the existing sources and destinations do not intersect with the DHP core. NV9000 panel operators cannot use DHP core sources or destinations directly.

▲ The DHP core comprises I/O cards that you insert in the router frame (and the cabled connections that go with them). However, the DHP core is neither identified nor configured in NV9000-SE Utilities.

It is possible for you to build dummy sources and destinations that describe the core into your NV9000 configuration. Doing so might help you organize your NV9000 configuration and might help you remember what cards and ports form the core. But remember that you **will not** be able to manipulate core resources directly.

You should make sure that the dummy sources and destinations are not part of any category and that the dummy sources and destinations are not selectable at any NV9000 control panel.

[9] Start the System with DHP

Write the new configuration to the NV9000 and restart the NV9000.

Then start the DHP service. The DHP service runs independently of the NV9000 software. That is, you can start and stop the NV9000 software without effecting DHP, and vice versa. The DHP service must be set to 'Automatic'.

Setting the Service to Automatic

Follow these steps while logged into the NV9000:

- 1 Right-click the 'NVCONFIG CONTROLLER' icon on the desktop. (This is equivalent to 'My Computer' on a regular PC desktop.)
- 2 Choose 'Manage' from the context menu.
- 3 When the 'Computer Management' window appears, choose 'Services and Applications'.

4 Right-click NvHybridSVC_(DHP) in the list of services:

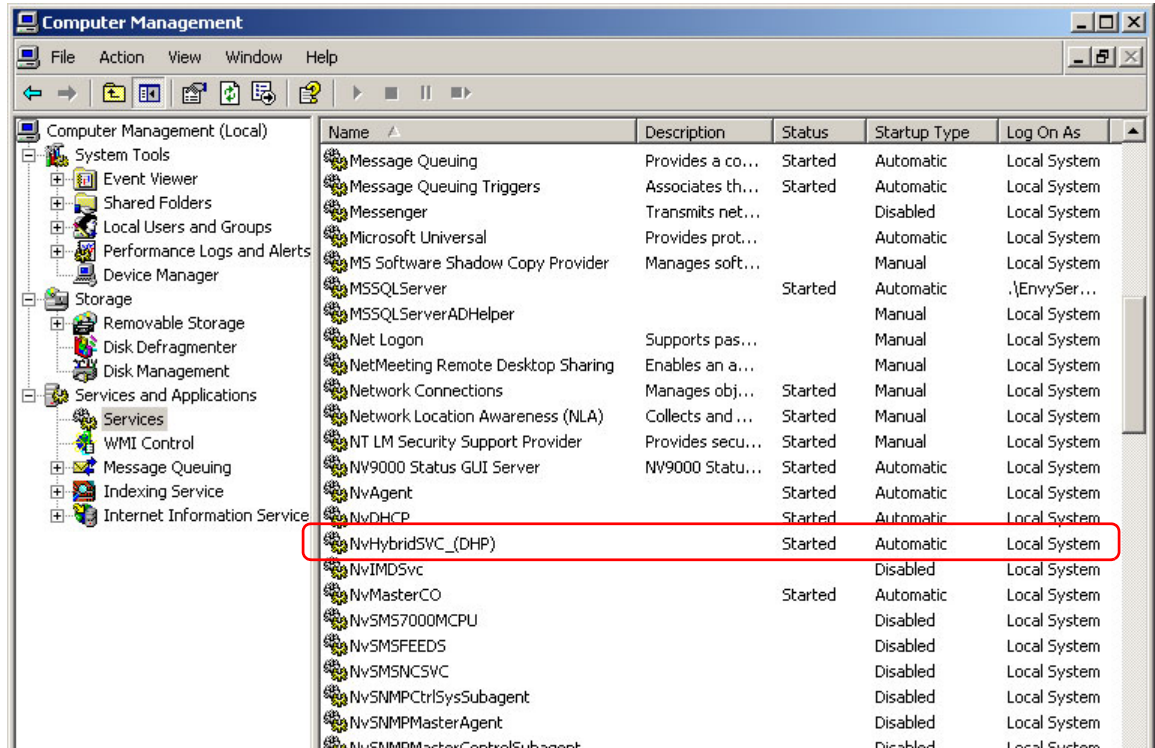

5 Select 'Properties' in the context menu. A dialog appears:

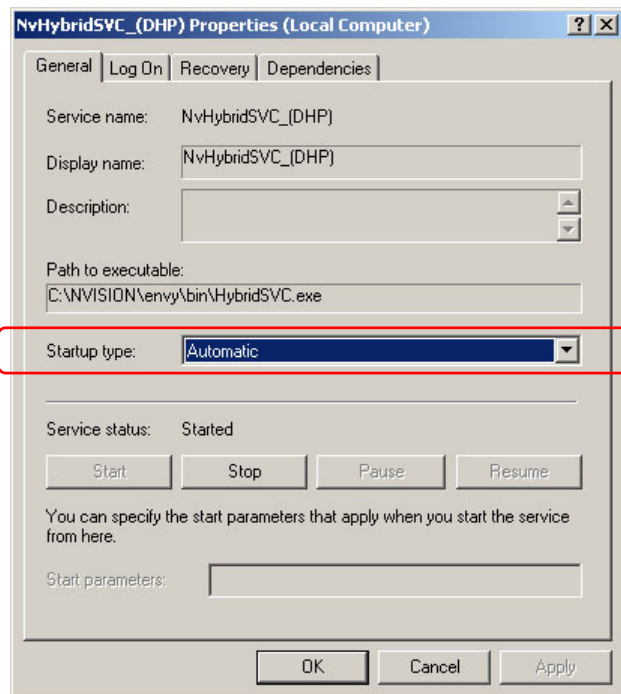

Choose 'Automatic' as the startup type.

Starting the Service

- 1 If necessary, navigate again to 'Services and Applications'.
- 2 Right-click NvHybridSVC_(DHP) in the list of services. Select 'Start' in the context menu:

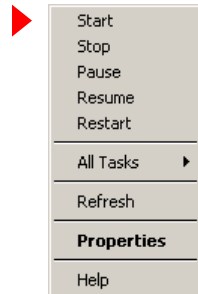

Verify

Test whether, in fact, you can take a standard source to a hybrid destination or vice versa. You can perform the take in MRC. To verify that takes are occurring properly, you will need video and audio monitors connected to the signals you are testing.

If the take does not occur, debugging will be required. Most likely, one of the DHP configuration files is wrong. (There is no feedback indicating DHP status.)

Correct any errors in the DHP configuration files and restart the NV9000 and restart DHP.

If DHP continues to fail, or for other failure symptoms, contact Grass Valley customer service.

DHP Features

Status

When the NV9000 requests crosspoint status, the status message from the router will actually be received by the DHP service. DHP will translate the addresses requested to the router's space and send the request to the router. After receiving a response, DHP will translate back into the NV9000's address space and reply to the NV9000. If the NV9000 tries to obtain the status of an area such as the embedded audio of a standard output port, it will receive what DHP "believes" to be routed there and not necessarily what is in the TDM matrix at that point.

Status also reports whether the source or destination is a hybrid-embedder card or a hybrid-disembedder card.

Takes

The service expects to receive grouped takes (meaning that all audio sources that are to be routed to the destination be included with the video.)

Standard or Embedder Output

If the take's destination is a standard port or an embedder port, and the service receives a take with (1) fewer than 16 audio sources or (2) no video source, the service uses the video and audio sources that are currently routed to the destination as the rest of the 16 audio levels and 1 video level. It will leave these levels untouched.

The service needs all 16 audio sources and a video source to determine whether it should route anything to a core disembedder or to a re-embedder.

If, during a take, a disembedder or re-embedder is needed and is not available, a status value will be sent back to the operator's control panel letting the operator(s) know that they have either no disembedders available or no re-embedders available.

MADI Output

MADI outputs are independent. Whatever is routed to one MADI output does not affect any other MADI output, even when the level set of the NV9000 destination includes multiple MADI outputs. MADI outputs that are unselected during a take remain unaffected.

Examples

There are 20 DHP scenarios, based on 4 kinds of input and 5 kinds of output. Many of the cases are similar. Some cases are very simple and some are not. In some cases (such as standard input to standard output) DHP actually does not use the DHP core, but simply passes the take commands through to the router.

The 20 cases are a cross-product of 4 input situations and 5 outputs, as follows:

Input Port(s)	Output Port(s)
A Standard	H Standard
B Disembedder	I Embedder
C MADI	J MADI
D Mixed (standard, disembedder, and MADI)	K Standard and MADI
	L Embedder and MADI

- ▲ Keep in mind that disembedder cards also emit (internally) the non-disembedded signal as well as the video and 16 disembedded audio channels. Similarly, embedder cards also accept video with embedded audio (in a "bypass" mode) and emits that video without further processing.
- ▲ The term MADI applies only to connectors and to external signals. Internally, the individual MADI signals are AES⁴ and are switched through a TDM "matrix."
- ▲ Signals processed through AES async cards cannot be part of DHP.
- ▲ The DHP core is required when audio shuffling is to be performed. Audio shuffling depends on the take, usually with breakaway, performed by the operator.

The following cases illustrate the different ways the DHP service handles routes.

4. The TDM matrix switches Dolby E, if it is present, as well as AES.

A-H, Case 1 **Standard to Standard**

In the simple case (no audio shuffling requested), the signal will pass straight through the router.

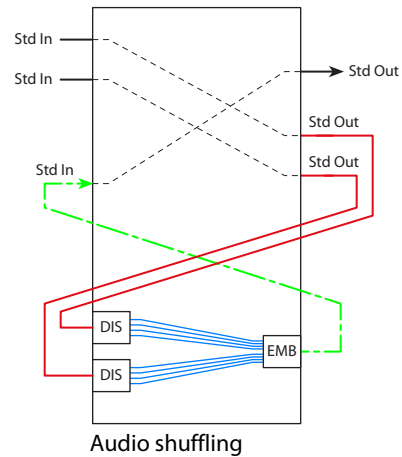
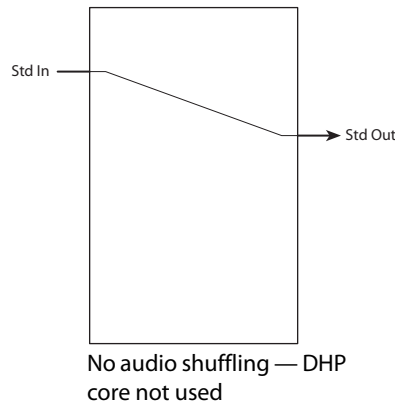

When audio signals are drawn from two (or more) sources, the audio must be disembedded, combined as the operator requested, and re-embedded.

A-I, Case 2 **Standard to Embedder**

In the simple case (no audio shuffling requested), the signal will pass straight through the router.

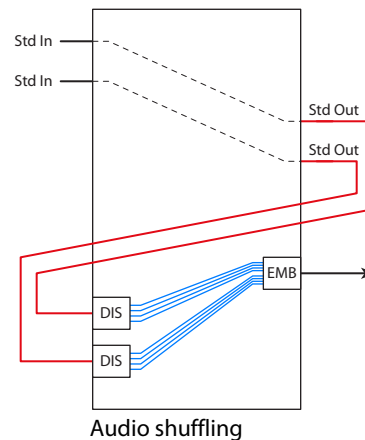
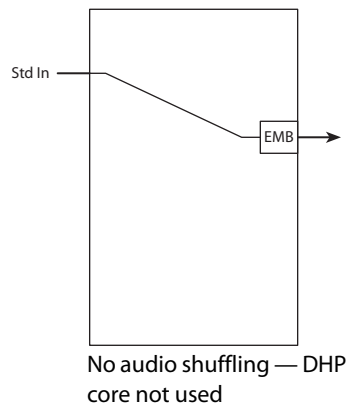

When audio signals are drawn from two (or more) sources, the audio must be disembedded, combined as the operator requested, and re-embedded.

The embedder port — chosen by the operator — is not part of the DHP core.

- ▲ The embedder port can accept video that already has embedded audio and output that video without further processing.

A-J, Case 3 **Standard to MADI**

A disembedder extracts the audio from the standard input. The audio is then distributed, through the TDM matrix, to the necessary MADI ports.

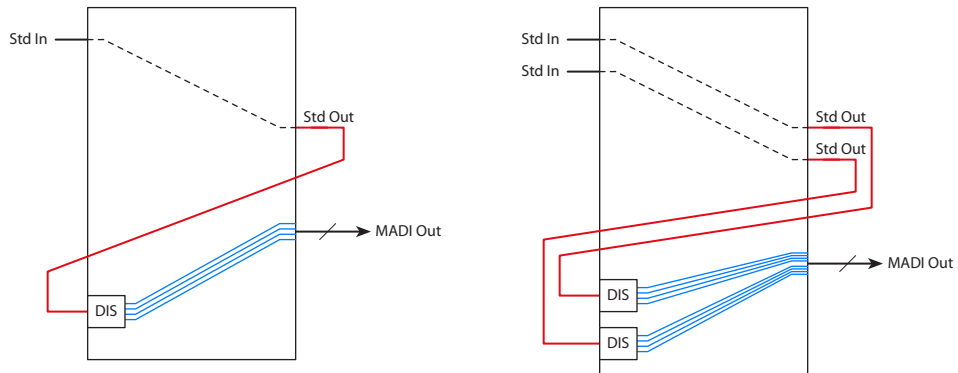

When audio signals are drawn from two (or more) sources, two (or more) disembedder ports are required.

Multiple MADI ports can be routed in a single take insofar as they are combined in the level set of the (audio) destination.

The video from the standard input(s) is ignored.

A-K, Case 4 **Standard to (Standard + MADI)**

A disembedder extracts the audio from the standard input. The audio is then distributed, through the TDM matrix, to the necessary MADI ports.

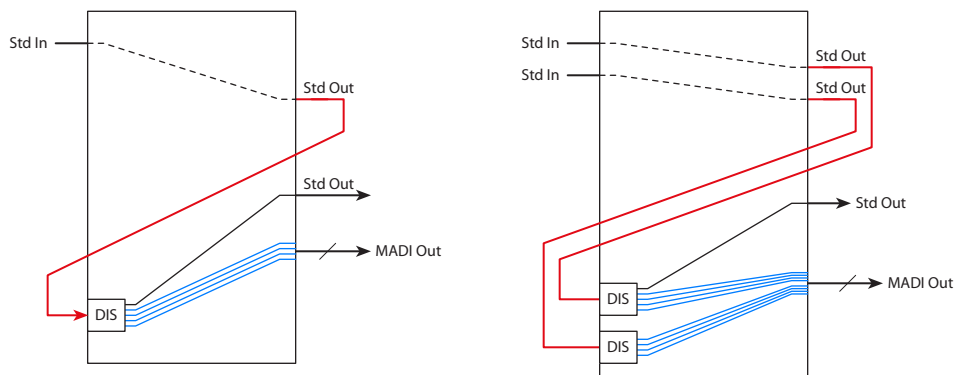

When audio signals are drawn from two (or more) sources, two (or more) disembedder ports are required.

The video signal (from one of the sources) is routed through the disembedder to the specified standard output.

It is possible for some of the audio to be sent to the standard output. After the audio is disembedded, it can be routed to any embedder output or MADI output:

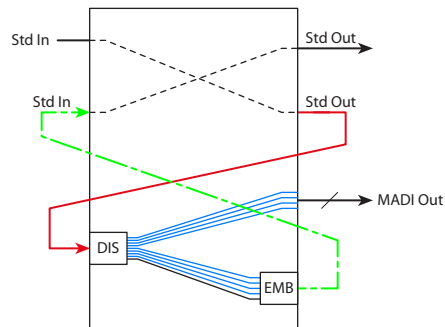

A-L, Case 5 **Standard to (Embedder + MADI)**

A disembedder extracts the audio from the standard input. The audio is then distributed, through the TDM matrix, to the necessary MADI ports.

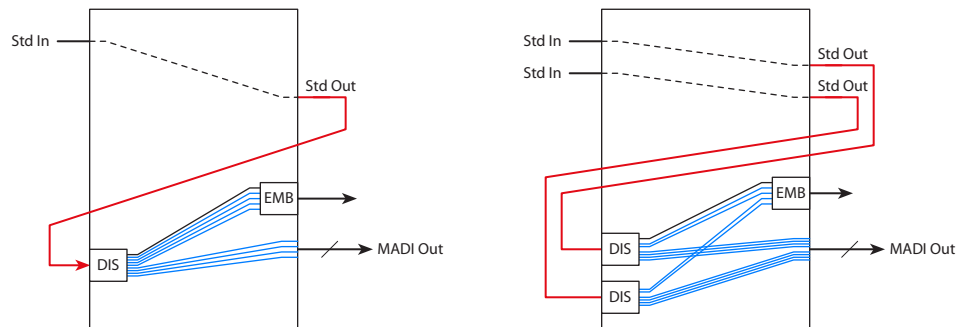

When audio signals are drawn from two (or more) sources, two (or more) disembedder ports are required.

The video signal (from one of the sources) is routed through the disembedder to an embedder output. The embedder port—chosen by the operator—is not part of the DHP core.

It is possible for some of the audio to be sent to the embedder output.

B-H, Case 6 **Disembedder to Standard**

In the simple case (no audio shuffling requested), the signal will pass straight through the router. The audio embedded in the input is passed, without processing, to the output. (In this situation, the DHP core is not required.)

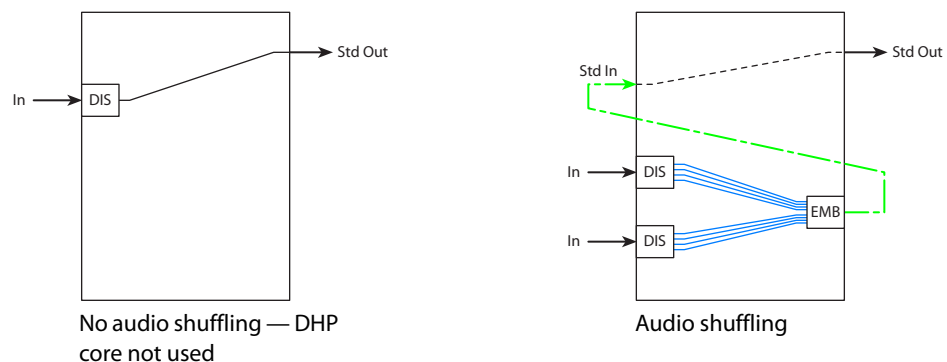

When audio signals are drawn from two (or more) sources, the audio must be disembedded, combined as the operator requested, and re-embedded.

B-I, Case 7 **Disembedder to Embedder**

In the simple case (no audio shuffling requested), the signal will pass straight through the router.

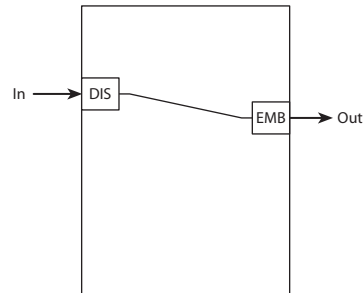

No audio shuffling — DHP core not used

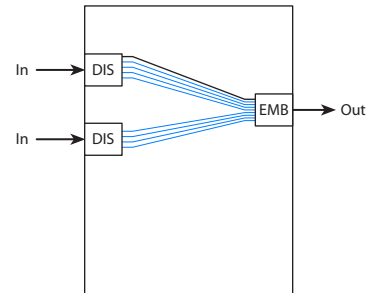

Audio shuffling

When audio signals are drawn from two (or more) sources, the audio must be disembedded, combined as the operator requested, and re-embedded.

The disembedder port(s) and the embedder port—chosen by the operator—are not part of the DHP core.

B-J, Case 8 **Disembedder to MAD I**

A disembedder extracts the audio from its own input. The audio is then distributed, through the TDM matrix, to the necessary MAD I ports.

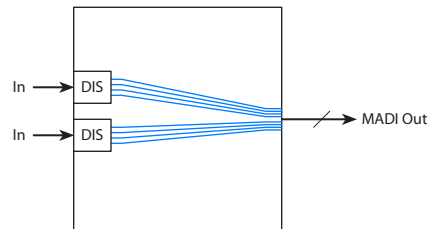
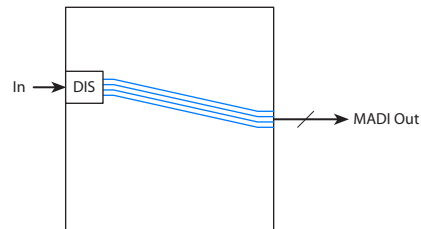

The audio signals can be drawn from two (or more) sources.

Multiple MAD I ports can be routed in a single take insofar as they are combined in the level set of the (audio) destination.

The video from the disembedder input(s) is ignored.

The disembedder port(s)—chosen by the operator—are not part of the DHP core.

B-K, Case 9 Disembedder to (Standard + MADI)

A disembedder extracts the audio from its own input. The audio is then distributed, through the TDM matrix, to the necessary MADI ports.

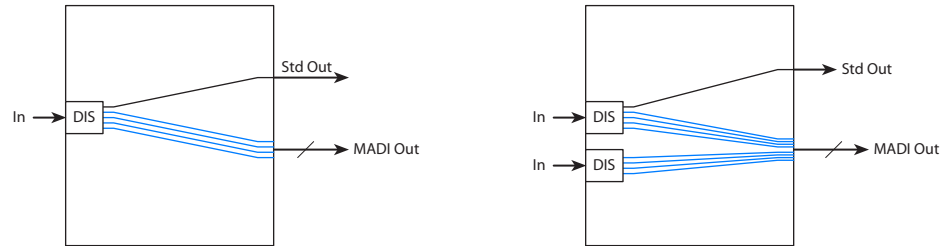

When audio signals are drawn from two (or more) sources, two (or more) disembedder ports are required.

The video signal (from the designated source) is directed to the designated standard output.

Multiple MADI ports can be routed in a single take insofar as they are combined in the level set of the (audio) destination.

The disembedder port(s) — chosen by the operator — are not part of the DHP core.

B-L, Case 10 Disembedder to (Embedder + MADI)

A disembedder extracts the audio from its own input. The audio is then distributed, through the TDM matrix, to the necessary MADI ports.

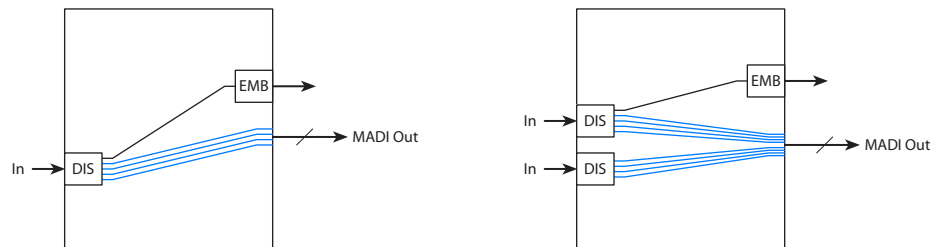

When audio signals are drawn from two (or more) sources, two (or more) disembedder ports are required.

The video signal (from the designated source) is directed to the designated embedder output.

The embedder port — chosen by the operator — is not part of the DHP core.

Multiple MADI ports can be routed in a single take insofar as they are combined in the level set of the (audio) destination.

The disembedder port(s) and embedder port — chosen by the operator — are not part of the DHP core.

C-H, Case 11 **MADI to Standard**

An embedder receives the audio from the designated MADI input port(s) through the TDM matrix. The embedded audio is then directed to the designated standard output.

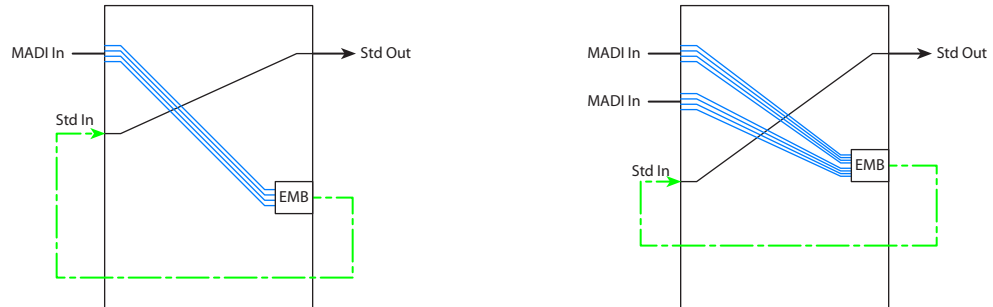

Audio signals can be drawn from two (or more) sources.
The video signal at the standard output is **not changed**.

C-I, Case 12 **MADI to Embedder**

The designated embedder port receives the audio from the designated MADI input port(s) through the TDM matrix.

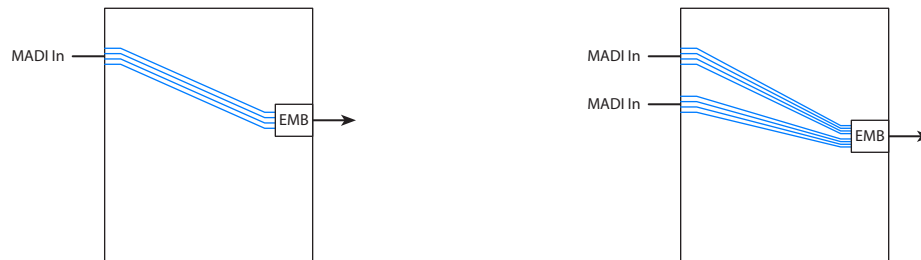

Audio signals can be drawn from two (or more) sources.
The video signal at the embedder output is **not changed**.
The embedder port — chosen by the operator — is not part of the DHP core.

C-J, Case 13 **MADI to MADI**

The MADI ports (identified by the level set of the take's destination) receive the audio from the designated MADI input port(s) through the TDM matrix.



Audio signals can be drawn from two (or more) sources.
No video signal is involved.

Multiple MADI ports can be routed in a single take insofar as they are combined in the level set of the (audio) destination.

C-K, Case 14 **MADI to (Standard + MADI)**

The destination can include a video port, one or more embedded audio channels, and one or more MADI ports. The embedded audio channels and the MADI ports (identified by the take's destination) receive the audio from the designated MADI input port(s) through the TDM matrix.

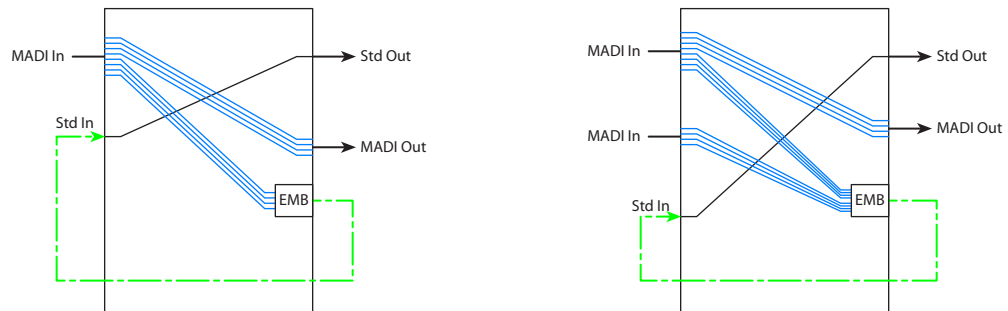

Audio signals can be drawn from two (or more) sources.

Some of the MADI inputs can be routed, through a DHP embedder, to a standard output.

The video signal at the standard output is **not changed**.

C-L, Case 15 **MADI to (Embedder + MADI)**

The destination can include a video port, one or more embedded audio channels, and one or more MADI ports. The embedded audio channels and the MADI ports (identified by the take's destination) receive the audio from the designated MADI input port(s) through the TDM matrix.

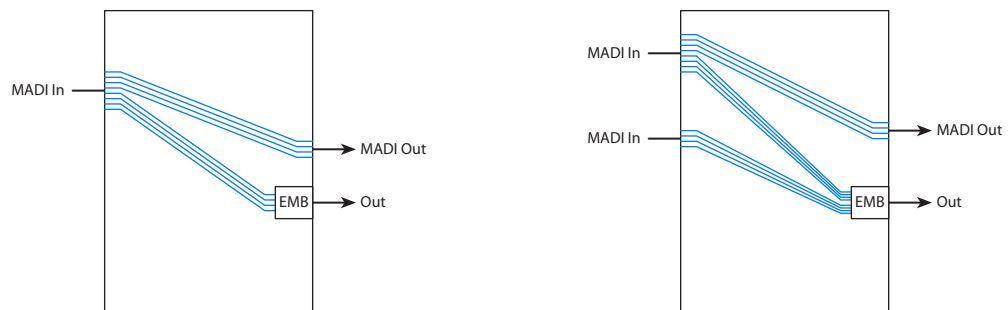

Audio signals can be drawn from two (or more) sources.

The video signal at the embedder port is **not changed**.

The embedder port — chosen by the operator — is not part of the DHP core.

D-H, Case 16 **Mixed to Standard**

In the case of mixed input (standard, disembedder, or MADI), audio is extracted from the various inputs according to the breakaway specified by the operator. If there are standard inputs among the mix, a disembedder in the DHP core is required to extract the audio from each one.

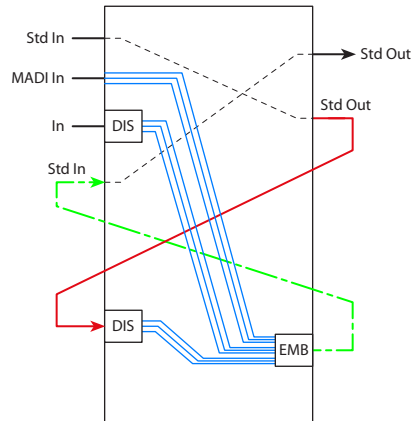

The audio from the various sources is re-embedded and sent to the designated standard output.

(Because the embedder card supports 16 audio channels, this scenario could potentially have up to 16 input sources of various kinds.)

D-I, Case 17 **Mixed to Embedder**

In the case of mixed input (standard, disembedder, or MADI), audio is extracted from the various inputs according to the breakaway specified by the operator. If there are standard inputs among the mix, a disembedder in the DHP core is required to extract the audio from each one.

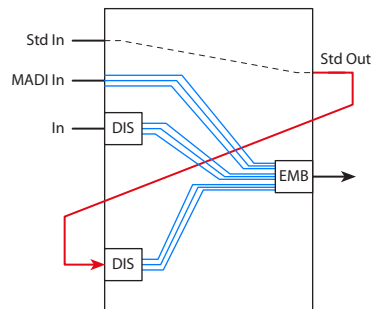

The audio from the various sources is re-embedded by the designated embedder output. The embedder port—chosen by the operator—is not part of the DHP core.

(Because the embedder card supports 16 audio channels, this scenario could potentially have up to 16 input sources of various kinds.)

D-J, Case 18 **Mixed to MAD I**

In the case of mixed input (standard, disembedder, or MAD I), audio is extracted from the various inputs according to the breakaway specified by the operator. If there are standard inputs among the mix, a disembedder in the DHP core is required to extract the audio from each one.

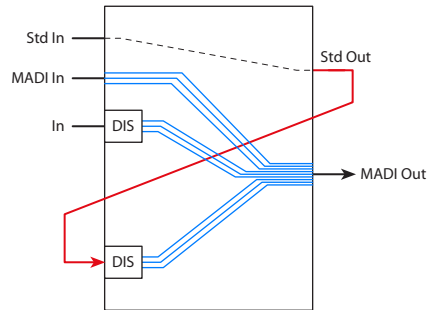

The audio from the various sources is routed through the TDM matrix to the MAD I ports designated by the operator.

(Because the embedder card supports 16 audio channels, this scenario could potentially have up to 16 input sources of various kinds.)

Multiple MAD I ports can be routed in a single take insofar as they are combined in the level set of the (audio) destination.

D-K, Case 19 **Mixed to (Standard + MAD I)**

In the case of mixed input (standard, disembedder, or MAD I), audio is extracted from the various inputs according to the breakaway specified by the operator. If there are standard inputs among the mix, a disembedder in the DHP core is required to extract the audio from each one.

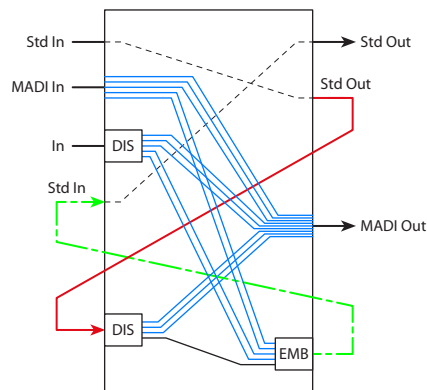

The audio from the various sources is routed through the TDM matrix to the ports designated by the operator. Some of the audio can be directed to MAD I output and some to the standard output, depending on the level set of the destination.

(Because the embedder card supports 16 audio channels, this scenario could potentially have up to 16 input sources of various kinds.)

Multiple MAD I ports can be routed in a single take insofar as they are combined in the level set of the (audio) destination.

The video signal can come from any standard input or disembedder input. It is the operator who designates the source of the video. The video is routed through an embedder port to the standard output chosen by the operator.

D-L, Case 20 **Mixed to (Embedder + MADI)**

In the case of mixed input (standard, disembedder, or MADI), audio is extracted from the various inputs according to the breakaway specified by the operator. If there are standard inputs among the mix, a disembedder in the DHP core is required to extract the audio from each one.

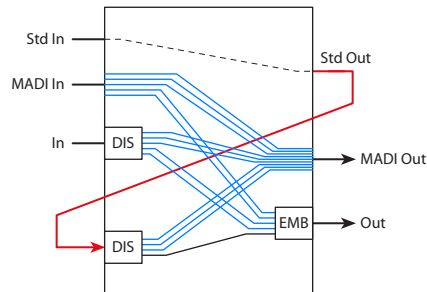

The audio from the various sources is routed through the TDM matrix to the ports designated by the operator. Some of the audio can be directed to MADI output and some to the embedder output, depending on the level set of the destination.

(Because the embedder card supports 16 audio channels, this scenario could potentially have up to 16 input sources of various kinds.)

The video signal can come from any standard input or disembedder input. It is the operator who designates the source of the video. The video is directed to the embedder port chosen by the operator. That port is not part of the DHP core.

Notes

Embedders and Disembedders

The DHP service keeps an internal list of which devices are already being disembedded so that it does not use up more than one disembedder for that device. It will not free the disembedder until **none** of its channels are being routed to destinations.

To clear a disembedder forcibly, an operator must route a new source to the disembedder's current destination(s). This action is tricky because there might be several destinations for each channel. (Clearing a disembedder might be hard for an operator to accomplish because it is not always obvious to what current destinations a disembedder is routed and the operator might not be able to tell where a particular disembedder source is routed). As long as one audio channel remains routed⁵ to a destination, the disembedder will **not** be free to use.

The web suite **does not have** commands that clear the disembedders and embedders used by the DHP core.

5. The channel is still listed in the disembedder data structures as having a destination

The DHP service also keeps an internal list of which devices are already being re-embedded so that if anyone would like to route that combination to another destination it will use the already assembled source.

To clear a re-embedder, route a new source to its ultimate destination.

If a disembedder is not available, or if a re-embedder is not available, the error status is returned in the router's response to the 'Take' command. The response goes back to the NV9000 and then, in some form, to the operator's panel.

Product Limitations

The DHP service currently does not understand what to do with AES asynchronous cards. (It is best to leave this area of the router as a blank in its configuration.)

The DHP service knows **only** of cards listed in `HybridCards_XXXX.cfg`. It will create a sparse internal matrix based on this information. If a card is removed or replaced with a different type, this file will need to be updated.

The `HybridPorts_XXXX.cfg` file is similar. DHP knows only of the port pairs defined in this file. If either of the configuration files has changed, the DHP service must be restarted. Follow these steps while logged into the NV9000:

- 1 Right-click the 'NVCONFIG CONTROLLER' icon on the desktop. (This is equivalent to 'My Computer' on a regular PC desktop.)
- 2 Choose 'Manage' from the context menu.
- 3 When the 'Computer Management' window appears, choose 'Services and Applications'.
- 4 Right-click `NvHybridSVC_(DHP)` in the list of services. Select 'Restart' in the context menu:

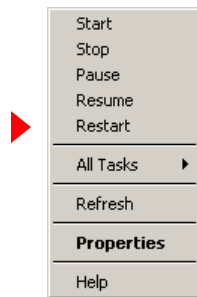

Be sure to update the configuration (i.e., initialization) files on both NV9000 system controllers if you have a redundant NV9000 system.

Architectural Defects

Even without DHP, it is possible for NV9000 panels to present false status. That is because the NV9000 gives status before it performs router operation such as a take. If the operation fails, the false status remains for a significant time (several seconds to a minute or more) before the NV9000 recognizes the true status of the router.

DHP was intended to be transparent. It is, perhaps, until a failure occurs. With DHP, take failures are possible, because DHP relies on a pool of resources that can become depleted.

3 NV9000 Web Suite

Chapter 3 provides detailed information about the DHP status portion of the NV9000 Web Suite.

Topics

Summary	37
DHP Pages	39
Sample NV9000 Data	46

Summary

The NV9000 Web Suite is a browser-based application that provides status for several NV9000 functions (DHP, trunks and crosspoints) and allows users to perform tasks, breakaway, level-mapping, locks, and protects.

Specifically applicable here are the web suite's pages for DHP status.

Note however that the web suite does not provide any control functions for DHP.

The web suite provides a relatively simple way to view the current state of the DHP core of an NV8500 series router. It provides data in both tabular and graphical formats.

The web suite is a browser application. Accessing the web suite depends on its location at your facility:

- If the web suite was installed on your PC, enter "localhost" in the URL field of your browser.
- If the web suite was installed on someone else's PC, enter the IP address of that person's PC. (Communicate with your system's administrator to obtain that IP address.)

If the web suite has been set up properly, it should immediately establish communication with a NV9000 system controller in your system. You might have to login to the web suite if you are not already logged in. Please refer to the *NV9000 Web Suite Users Guide* for details.

Note:

- ▲ The web suite requires a browser that supports HTML 5, such as Firefox or Chrome.¹ The web suite is also designed to operate well on hand-held devices such as iPads, ViewSonic tables, Motorola Zoom tables and others. (If your browser does not support HTML 5, the web suite will tell you.)
- ▲ At present, the web suite provides status for only one router using DHP. The NV9000 system controller you are monitoring must have only one DHP service running.
- ▲ To use the web suite, you must have been assigned a user name and (optionally) a password. Either you or your system's administrator will have configured the web suite for a number of users and for access to a specific NV9000 family system controller.
- ▲ The DHP service can communicate with only one instance of the web suite. However, multiple users can use the same instance.

1. Internet Explorer v10 supports HTML 5.

After you have accessed the web suite and have chosen its DHP tab (or one of its DHP tabs if it has more than one) you will see a window similar to the following:

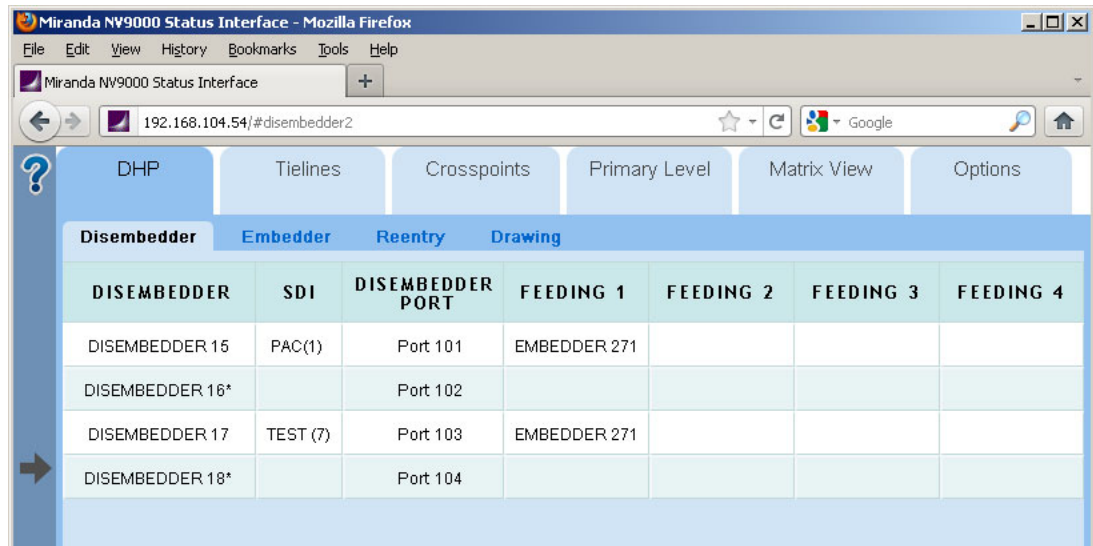

Fig. 3-1: DHP Tab of the Web Suite

Within the web suite window, there are two tiers of tabbed pages. You will see two rows of “tabs.”

The upper row of tabs selects a function within the web suite. Presently there are 5 functions in the upper row and a sixth tab in which you can configure the web suite itself:

- DHP
The DHP pages present tables and diagrams of DHP usage. This of course is of primary concern to DHP users.
 - ▲ You might see the term “DHP Management.” Note however that the DHP pages are simply status pages.
- Tielines
The tielines pages present tables and diagrams of tieline usage. In general, this tab important if your system uses tielines, and might or might not be of interest to DHP users.
- Multi-Level
The multi-level tab presents a detailed table of “crosspoint” data. Although the data are important, they do not have a direct bearing on the use of DHP pages.
- Primary Level
The primary level presents a less detailed table of “crosspoint” data. Although the data are important, they do not have a direct bearing on the use of DHP pages.
- Matrix View
The matrix view can be of some use to DHP users. It displays your system’s “crosspoint” data in a grid and indicates where connections are locked and where breakaway or level-mapping occurs.
In this view, you can perform takes, locks, and protects in the matrix view and you can release locks and protects.

- Options

The 'Options' tab allows users (with admin privilege) to configure the web suite's interfaces. Those users may also create additional tabs that show different views of NV9000 data. It also provides logging data for Grass Valley service technicians.

The second row of tabs belongs to whatever category you have selected in the upper row. For DHP, there are 4 tabbed pages:

DHP disembedder	DHP embedder
DHP re-entry	DHP drawing

For information about other tabs and pages, please refer to the *NV9000 Web Suite Users Guide*.

DHP Pages

The four DHP pages show information about the current state of the DHP core of a single NV8500 series router (NV8144, NV8280, NV8576, or NV8576-Plus).

▲ DHP does not (yet) support the NV8140.

Three of its pages present *tables* of DHP core data. The fourth page presents the data as a drawing. The drawing page is a "schematic" view of the current core. The table data present either a subset of the signal detail of the DHP core or all of it, depending on configuration of the web suite.

The following sections describe the pages.

The examples shown in this section refer to a demonstration system. The configuration data for that system are listed in the [Sample NV9000 Data](#) on page 46.

Example

Figure 3-2 shows an DHP routing example for the 4 tabbed pages described in the following sections:

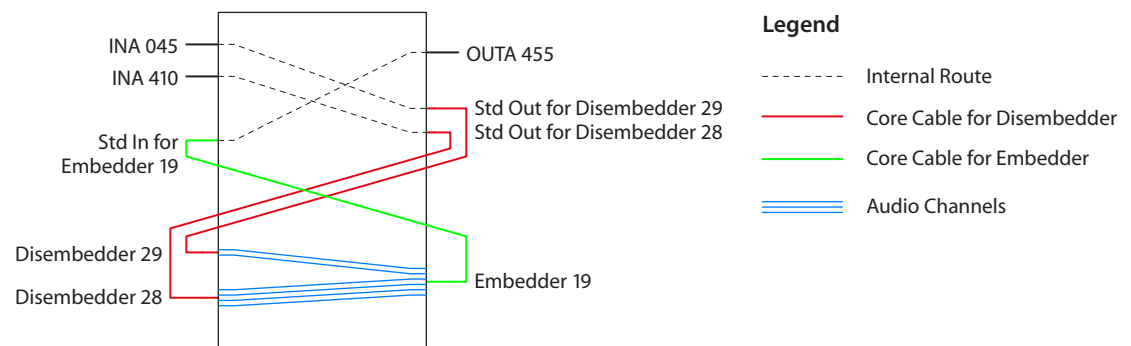
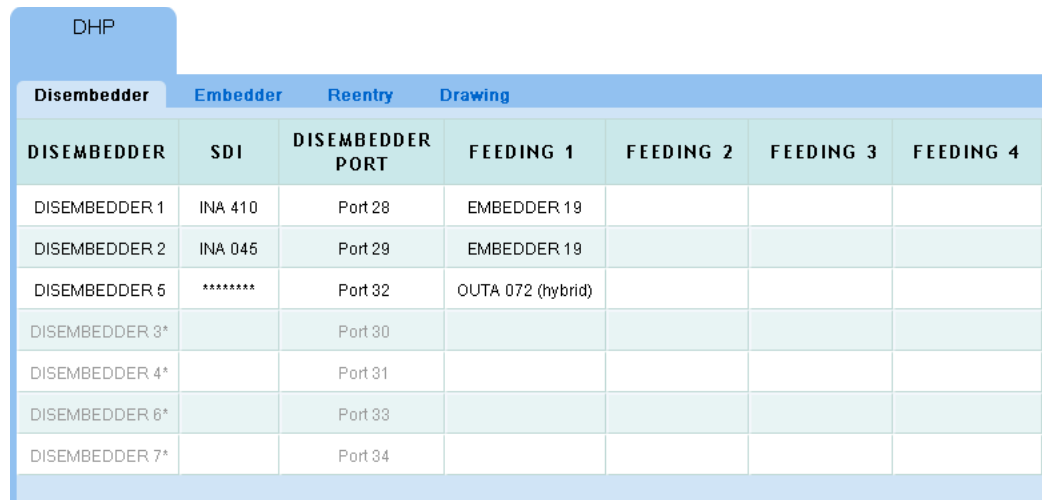

Fig. 3-2: Sample DHP Route

In this example, standard source INA 410 is taken to standard destination OUTA 455 on all levels but two. The remaining two levels (levels 3 and 4) are taken from standard source INA 045. Except for the breakaway involved, DHP would not be required. Because a breakaway occurred, the DHP software routed INA 410 through DHP disembedder port 28 and INA 045 through DHP disembedder port 29. The audio from these two ports are recombined in DHP embedder port 19 and forwarded, with the original video from INA 410 to standard output OUTA 455.

DHP Disembedder

The 'DHP Disembedder' page shows details of the DHP core's *disembedders*:



DHP						
Disembedder	Embedder	Reentry	Drawing			
DISEMBEDDER	SDI	DISEMBEDDER PORT	FEEDING 1	FEEDING 2	FEEDING 3	FEEDING 4
DISEMBEDDER 1	INA 410	Port 28	EMBEDDER 19			
DISEMBEDDER 2	INA 045	Port 29	EMBEDDER 19			
DISEMBEDDER 5	*****	Port 32	OUTA 072 (hybrid)			
DISEMBEDDER 3*		Port 30				
DISEMBEDDER 4*		Port 31				
DISEMBEDDER 6*		Port 33				
DISEMBEDDER 7*		Port 34				

Fig. 3-3: DHP Disembedder Page

The page displays a table of disembedder ports in the DHP core, one row for each port. The disembedder ports are identified in column 1. If a disembedder is not in use, its table row is dimmed.

Entries in the column labeled 'SDI' show the name and port number of the standard video input port connected to the disembedder port.

The entries in the columns labeled 'Feeding 1', 'Feeding 2', and so on, show output ports that are fed by the disembedder port. (The number of "Feeding" columns is a DHP page preference.)

DHP Embedder

The 'DHP Embedder' page shows details of the DHP core's *embedders*. The page displays a table of embedder ports in the DHP core, one row for each port. The embedder ports are identified in column 1. If an embedder is not in use, its table row is dimmed.

The table always has 16 audio columns because each audio channel of the embedder port receives audio from some source (even if it is only silence). However, as a page preference, you can specify the columns (levels) that are displayed. Figure 3-4 shows the left portion of the page:

DHP										
Disembedder	Embedder	Reentry	Drawing							
EMBEDDER	SDI	AUDIO 1	AUDIO 2	AUDIO 3	AUDIO 4	AUDIO 5	AUDIO 6	AUDIO 7	AUDIO 8	AUDIO 9
EMBEDDER 19	INA 410	INA 410	INA 410	INA 045	INA 045	INA 410	INA 410	INA 410	INA 410	INA 410
EMBEDDER 20*										
EMBEDDER 21*										
EMBEDDER 22*										
EMBEDDER 23*										
EMBEDDER 24*										
EMBEDDER 25*										
EMBEDDER 26*										

Fig. 3-4: DHP Embedder Page, Left Portion

Entries in the column labeled 'SDI' show the name and port number of the standard input port connected to the disembedder port that feeds the video to the embedder port.

The entries in the columns labeled 'Audio 1', 'Audio 2', and so on, show the audio channels that are fed to the embedder port. The audio signals can come from any disembedder in the DHP core.

The audio channels are identified by the video port names and audio port numbers assigned to them in NV9000-SE Utilities.

DHP Re-Entry

The 'DHP Re-Entry' page shows which standard video input and standard video outputs are connected to each embedder port:

DHP						
Disembedder	Embedder	Reentry	Drawing			
EMBEDDER	SDI SRC	REENTRY	DEST 1	DEST 2	DEST 3	DEST 4
EMBEDDER 19	INA 410	Source Port 1	OUTA 455			
EMBEDDER 20*		Source Port 2				
EMBEDDER 21*		Source Port 3				
EMBEDDER 22*		Source Port 4				
EMBEDDER 23*		Source Port 5				
EMBEDDER 24*		Source Port 6				
EMBEDDER 25*		Source Port 7				

Fig. 3-5: DHP Re-Entry Page

Another way you can think of this is that the table shows the standard video connections that use the DHP core, and which embedder card is used for each connection. The table does not show any other information.

The page displays a table of all the embedder ports in the DHP core, one row for each port. The embedder ports are identified in column 1. If an embedder is not in use, its table row is empty (except for column 1).

Entries in the column labeled 'SDI SRC' show the name and port number of the standard input port connected (indirectly) to the embedder port. It represents the video signal at the standard input.

The entries in the columns labeled 'Dest 1', 'Dest 2', and so on, show output ports that are fed by the embedder port. (As a page preference, you can specify the number of "Dest" columns to display.) The DHP service detects when a route using the core has exactly the same sources, video and audio, as another route through the core. It then connects the multiple outputs to the same standard input card of the core as shown in the example following.

If the embedder card connects to more than 8 outputs, the display changes to increase the height of the table row for that embedder and the additional outputs "wrap" around to the column labeled 'Dest 1' and so on. The height of the table row will adjust to accommodate all the destinations corresponding to that embedder port.

DHP Drawing

The 'DHP Drawing' page gives you a graphic, i.e., schematic, view of the DHP core and the signals currently connected to the core.

It has the additional advantage of showing MADI, disembedder, and embedder connections that are not part of the core.

This image is a sample showing some connections of the small demonstration system:

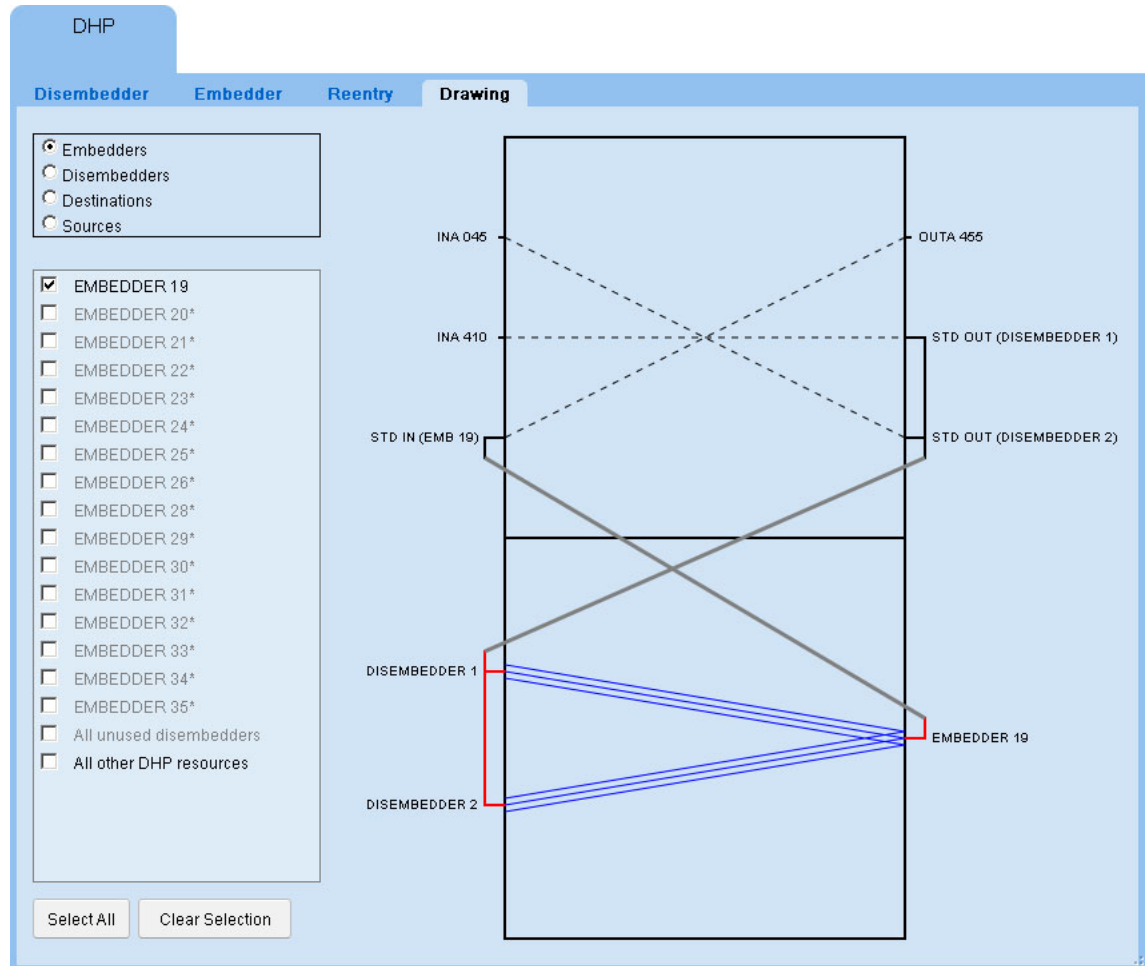

Fig. 3-6: DHP Drawing Page

Central to the page is a rectangle representing the router connected to the DHP service.

The top half of the rectangle represents *standard* input and output ports, some of which are part of the DHP core.

The bottom half of the rectangle represents hybrid inputs and outputs. Hybrid I/O includes disembedder ports, embedder ports, and MAD I input or output connections.

Signal Paths

Dashed lines represent standard inputs and outputs connected to the core. For instance, in the illustration, INA 045 is a standard input and OUTA 455 is a standard output. See the [Sample NV9000 Data](#), following.

Solid lines represent paths within the DHP core. Single black lines represent video with or without embedded audio. Blue 3-line groups represent audio disembedding and re-embedding. The 3-line groups represent any number of audio channels (from 1 to 16), not just 3.

Short red lines represent connections to the disembedders and embedders of the core.

Usage

At the left side of the page are two regions:

- Radio buttons.

The 4 radio buttons allow you to select what appears in the check boxes in the second region. For instance, if you select the 'Embedders' radio button, a list of the embedders appears in the second region.

- Check boxes.

When you check a box in this region, the drawing shows all DHP elements that relate to what you have checked. For example, Figure 3-6, on page 43, has disembedder 19 checked. The drawing shows the embedders, standard inputs, and standard outputs that connect to disembedder 19.

Depending on which radio button you chose, the check box list will include special check boxes: 'All unused disembedders', 'All unused embedders', or 'All other DHP resources'. Checking one of these boxes will result in the display of the named items.

Also at the left side of the page are two buttons:

- Select All.

This is a shortcut that checks all the check boxes in the list and causes the drawing to show all the items corresponding to all the check boxes.

- Clear Selection.

This shortcut clears all the check boxes in the list. The result is that the drawing shows nothing (except the rectangle representing the router).

When you select many or all items in the check box list, the drawing shows many connections:

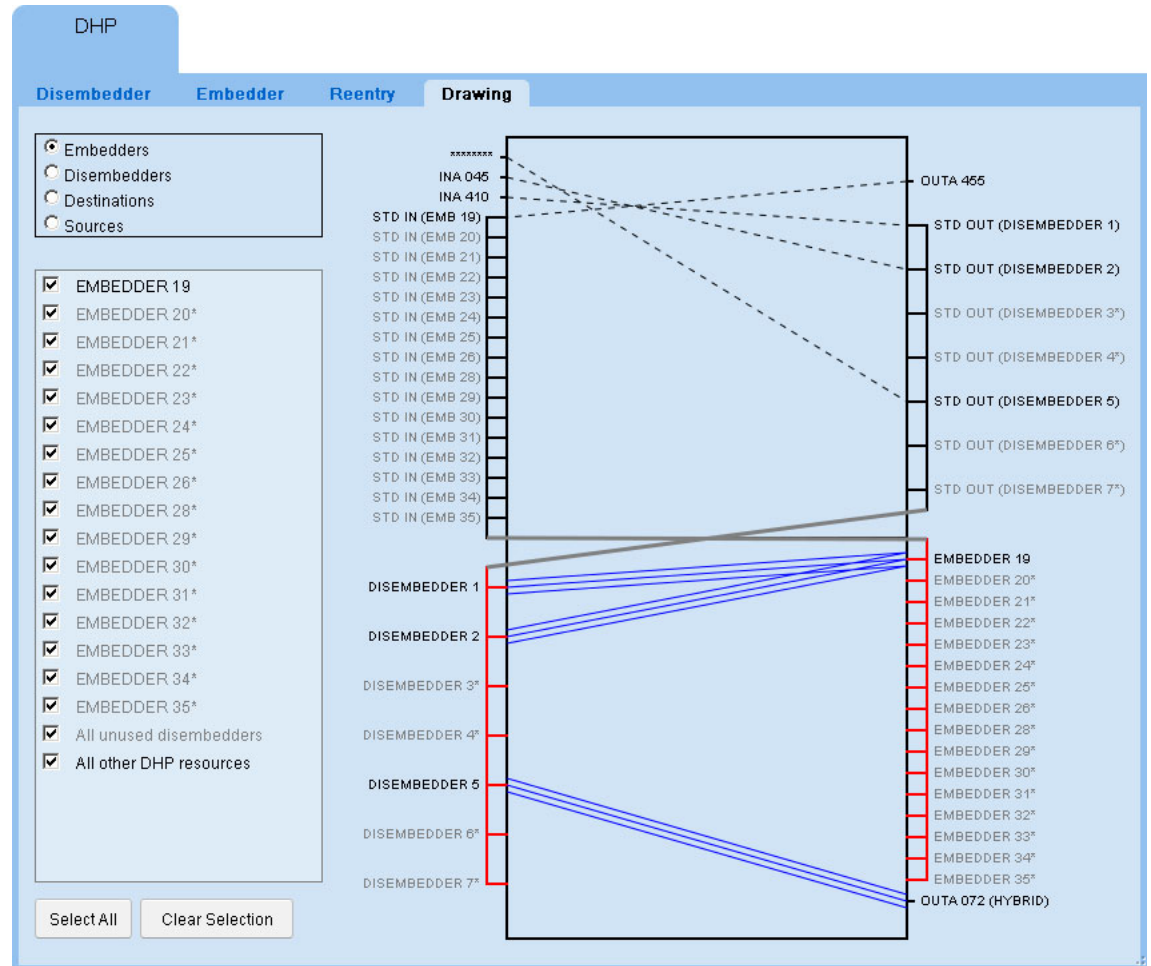

This kind of view has its uses, but also obscures individual connection details.

Preferences

Each of the DHP pages has several user-selectable preferences, available in the sidebar of the web suite. Refer to the NV9000 Web Suite Users Guide for details on DHP display preferences and DHP page configuration options.

Sample NV9000 Data

These are the data of the NV9000 configuration from which the DHP example was taken.

Non-Core Ports

These are the ports — *not in the DHP core* — that are used in the examples. These were configured in NV9000-SE Utilities.

Input

These are all standard inputs, each having video and 16 audio channels.

Device	HD Port	Audio Ports
INA 37	37	577–592
through		
INA 576	576	9201–9216

There are also MAD I ports 1–64 from input card 1

Output

These are all standard outputs, each having video and 16 audio channels.

Device	HD Port	Audio Ports
OUTA 37	37	577–592
through		
OUTA 576	576	9201–9216

There are also MAD I ports 1–64 on output card 1.

DHP Core Ports

These are the ports of the DHP core, as configured in the `HybridPorts_XXXX` file (one of the two DHP configuration files).

Re-embedders tied to Standard Inputs

Embedder Port	Standard Input Port
19	1
20	2
21	3
22	4
23	5
24	6
25	7
26	8
28	10
29	11
30	12
31	13
32	14
33	15
34	16
35	17

(These embedder outputs are all on output card 2. Note that the ports that would be numbered 27 and 36 do not exist.)

Disembedders tied to Standard Outputs

Disembedder Port	Standard Output Port
28	1
29	2
30	3
31	4
32	5
33	6
34	7

4

Misc. Topics

Chapter 4 provides additional information.

Topics

<i>Parts</i>	49
<i>Slot Numbers</i>	51

Parts

I/O Cards

Order Code	Description
8144-3GIG-IN-COAX	Standard 9-input card, 3Gig, HD, or SD, for use with coax connectors <i>for the NV8144.</i>
8144-3GIG-OUT-COAX	Standard 18-output card, 3Gig, HD, or SD, for use with coax connectors <i>for the NV8144.</i>
8144-HD-IN-COAX	Standard 9-input card, HD or SD, for use with coax connectors <i>for the NV8144.</i>
8144-HD-OUT-COAX	Standard 18-output card, HD or SD, for use with coax connectors <i>for the NV8144.</i>
8500-3GIG-IN-COAX	Standard 9-input card, 3Gig, HD, or SD, for use with coax connectors.
8500-3GIG-IN-FIBER	Standard 9-input card, 3Gig, HD, or SD, for use with SFP connectors.
8500-3GIG-OUT-COAX	Standard 18-output card, 3Gig, HD, or SD, for use with coax connectors.
8500-3GIG-OUT-COAX-EXP	Standard 8-output expansion card, 3Gig, HD, or SD, for use with coax connectors.
8500-3GIG-OUT-FIBER	Standard 18-output card, 3Gig, HD, or SD, for use with SFP connectors.
8500-3GIG-OUT-FIBER-EXP	Standard 8-output expansion card, 3Gig, HD, or SD, for use with SFP connectors.
8500-AES-ASYNC-IN	Standard 9-input card, AES async, for use with coax connectors.
8500-AES-ASYNC-OUT	Standard 18-output card, AES async, for use with coax connectors.
8500-AES-ASYNC-OUT-EXP	Standard 8-output expansion card, AES async, for use with coax connectors.
8500-HD-IN-COAX	Standard 9-input card, HD or SD, for use with coax connectors.
8500-HD-OUT-COAX	Standard 18-input card (HD or SD) for use with coax connectors.
8500-HD-OUT-COAX-EXP	Standard 9-output expansion card (HD or SD) for use with coax connectors.

Order Code	Description
8500H-IP-3G-DEM-CX	Hybrid 8-input disembedder card (3Gig, HD, or SD) for use with coax connectors.
8500H-IP-3G-FBR	Hybrid 8-input disembedder card (3Gig, HD, or SD) for use with SFP connectors.
8500H-IP-3G-TDM-CX	Hybrid MADI input card, 8 video inputs (3Gig, HD, or SD) and 1 MADI input, for use with coax connectors.
8500H-OP-3G-EMB-CX	Hybrid 16-output embedder card (3Gig, HD, or SD) for use with coax connectors.
8500H-OP-3G-FBR	Hybrid 16-output embedder card (3Gig, HD, or SD) for use with SFP connectors.
8500H-OP-3G-TDM-CX	Hybrid MADI card, 16 video outputs (3Gig, HD, or SD) and 2 MADI outputs, for use with coax connectors.
8500H-OPX-3G-EMB-CX	Hybrid embedder expansion output card, 8 outputs (3Gig, HD, or SD) for use with coax connectors.
8500H-OPX-3G-FBR	Hybrid embedder expansion output card, 8 outputs (3Gig, HD, or SD) for use with SFP connectors.
8500H-OPX-3G-TDM-CX	Hybrid MADI expansion output card, 8 video outputs (3Gig, HD, or SD) and 1 MADI output, for use with coax connectors.

I/O Backplane Connector Modules

Order Code	Description
I08500-3GIG-IN-COAX	8500 9IN 3GIG COAX Rear
I08500-3GIG-IN-FIBER	8500 9IN 3GIG FIBER Rear
I08500-3GIG-IN-SFP	8500 2IN Optical SFP Module
I08500-3GIG-OUT-COAX	8500 18OUT 3GIG COAX Rear
I08500-3GIG-OUT-COAX-EXP	8500 9OUT W/EXP 3GIG COAX Rear
I08500-3GIG-OUT-FIBER	8500 18OUT 3GIG FIBER Rear
I08500-3GIG-OUT-FIBER-EXP	8500 9OUT W/EXP FIBER Rear
I08500-3GIG-OUT-SFP	8500 2OUT Optical SFP Module
I08500-AES-IN-BAL	8500 9in AES BAL Rear
I08500-AES-OUT-BAL	8500 18out AES BAL Rear
I08500-AES-OUT-BAL-EXP	8500 9out w/EXP AES BAL rear
I08500-IP-3G-CWDM-SFP	8500 2IN CWDM SFP
I08500-OP-3G-CWDM-SFP-27/29	8500 2OUT 1271/1291nm, SFP
I08500-OP-3G-CWDM-SFP-31/33	8500 2OUT 1311/1331nm,SFP
I08500-OP-3G-CWDM-SFP-35/37	8500 2OUT 1351/1371nm, SFP
I08500-OP-3G-CWDM-SFP-39/41	8500 2OUT 1391/1411nm, SFP
I08500-OP-3G-CWDM-SFP-43/45	8500 2OUT 1431/1451nm, SFP
I08500-OP-3G-CWDM-SFP-47/49	8500 2OUT 1471/1491nm, SFP
I08500-OP-3G-CWDM-SFP-51/53	8500 2OUT 1511/1531nm, SFP

Order Code	Description
I08500-0P-3G-CWDM-SFP-55/57	8500 2OUT 1551/1571nm,SFP
I08500-0P-3G-CWDM-SFP-59/61	8500 2OUT 1591/1611nm, SFP
I08500-SD-HD-IN-COAX	8500 9IN SD/HD COAX Rear
I08500-SD-HD-OUT-COAX	8500 18OUT SD/HD COAX Rear
I08500-SD-HD-OUT-COAX-EXP	8500 9OUT W/EXP HD COAX REAR

These are the hybrid disembedder and embedder cards:

8500H-IP-3G-DEM-CX	(Disembedding)
8500H-OP-3G-EMB-CX	(Embedding)
8500H-OPX-3G-EMB-CX	(Embedding, expansion)

These are the hybrid MADI cards:

8500H-IP-3G-TDM-CX	Input
8500H-OP-3G-TDM-CX	Output
8500H-OPX-3G-TDM-CX	Output, expansion

There are no fiber hybrid cards at this time.

Slot Numbers

It is important use the correct slot numbers when preparing DHP's Hybrid cards_XXXX.cfg files.

Port numbering for any of the NV8500 family routers follows the labeled slot numbers.¹

NV8144, NV8140, or NV8280

For the NV8144, the slot numbering is very simple:

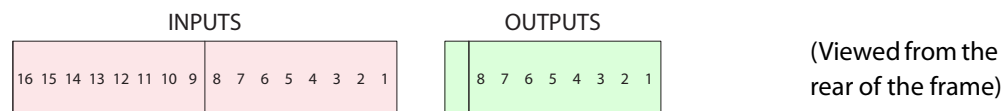

For the NV8140, the slot numbering is very simple:

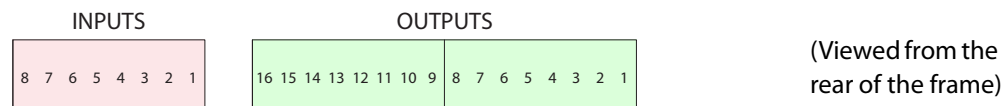

For the NV8280, there are 32 output slots and 32 input slots.

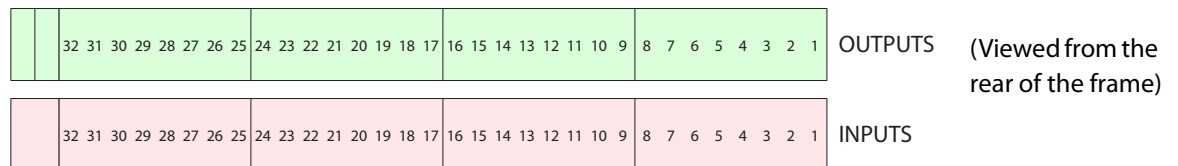

1. Older NV8500 routers in the field might have different slot labeling.

NV8576

For the NV8576, there are 64 output slots and 64 input slots:

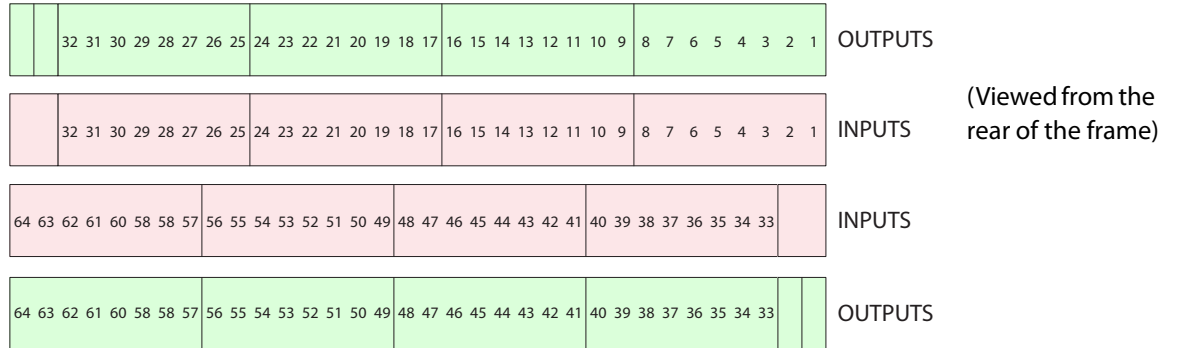

NV8576-Plus

For the NV8576, there are 64 output slots and 64 input slots, numbered 1–64, in each frame:

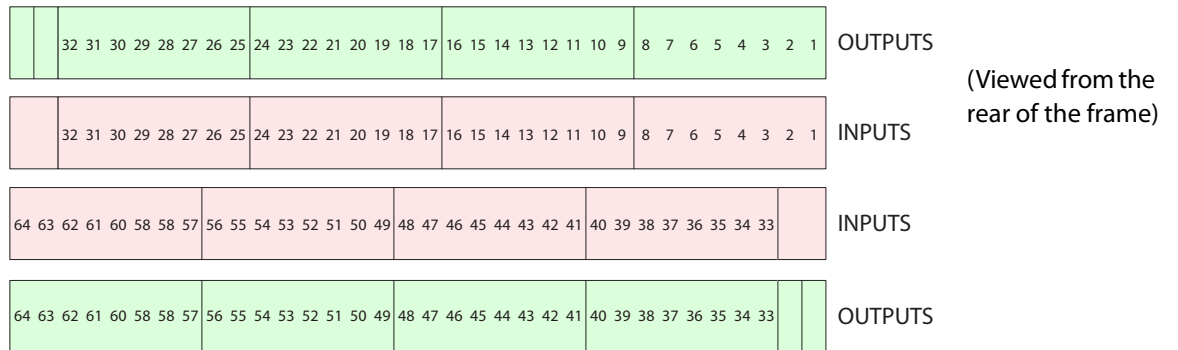

Fig. 4-1: NV8576-Plus Slot Order (for Each Frame)

Index

0–9

3Gig video	1, 8
8144-3GIG-IN-COAX	8
8144-3GIG-OUT-COAX	8
8144-HD-IN-COAX	8
8144-HD-OUT-COAX	8
8500-3GIG-IN-COAX	8
8500-3GIG-IN-FIBER	8
8500-3GIG-OUT-COAX	8
8500-3GIG-OUT-COAX-EXP	8
8500-3GIG-OUT-FIBER	8
8500-3GIG-OUT-FIBER-EXP	8
8500-HD-IN-COAX	8
8500-HD-OUT-COAX	8
8500-HD-OUT-COAX-EXP	8
8500H-IP-3G-DEM-CX	6, 51
8500H-IP-3G-TDM-CX	51
8500H-IP-TDM-CX	8
8500H-OP-3G-EMB-CX	6, 8, 51
8500H-OP-3G-TDM-CX	8, 51
8500H-OPX-3G-EMB-CX	6, 8, 51
8500H-OPX-3G-TDM-CX	8, 51

A

Activation	4, 7
AES, asynchronous	1, 24, 35
Africa, contact	57
Agreement, license	iii
Americas, contact	57
ASI signals	6
Asia, contact	57
Asynchronous AES	1, 24, 35
Audio levels in standard I/O	19
Audio shuffling	8, 24–25

B

Backplane connector modules	2, 10, 50
-----------------------------	-----------

C

Card locations	13–14
----------------	-------

Card types	9
Cards, control	1
Cards, crosspoint	1
Cards, disembedder	1, 3, 8, 13, 16–17, 23–24, 34, 51
Cards, embedder	1, 3, 13, 16–17, 23–24, 34, 51
Cards, expansion output	3–4
Cards, MAD1	1, 3, 8, 13, 24, 51
Cautions	vi
CD, NV9000 control system	7
CE	iii
Change history	iii
CHANNELS command	16–17
Chapters	
1, Introduction	1
2, DHP	7
3, NV9000 Web Suite	37
4, Misc. Topics	49
China, contact	57
Clearing a disembedder	34
Clearing an embedder	35
Coax connectors	2
Commands	
CHANNELS	16–17
END	14
EO	16, 18
frame type	14
IN	16
OUT	16
section	14
slot type	14
TL	16, 18
VO	16, 18
Comments, configuration file	15
Configuration	9–10, 21
Configuration files	9
Configuration files, DHP	7
Connectors, coax	2
Connectors, fiber optic	2
Connectors, quick-release	2
Connectors, WECO	2
Contact Miranda	57
Control cards	1
Control points table	12–13
Core, DHP	5, 9–10, 14, 24, 34, 39, 46
Corporate office, contact	57
Crosspoint cards	1
Crosspoint matrices	20
Customer support	57

D

Declaration of Conformance	iii
DHP (dynamic hybrid pathfinding)	4
DHP activation file	7
DHP analysis	5
DHP configuration	9–10
DHP configuration files	7, 9
DHP core	5, 9–10, 14, 24, 34, 39, 46
DHP disembedder (page)	40
DHP drawing (page)	42
DHP embedder (page)	41
DHP features	23
DHP initialization files	6
DHP license	4, 7
DHP links	5
DHP ports	9, 12–13
DHP re-entry (page)	42
DHP scenarios	5, 24
DHP tab	38
DHP, restarting	21, 35
DIN 1.0/2.3	2
DIP switch, MADI	1
Disembedder cards	1, 3, 8, 10, 13, 16–17, 23–24, 34, 51
Disembedder input	24, 27–29
Disembedder port	4–5, 14, 16, 40
Disembedder ports	47
Disembedder preferences	45
Document revision	iii
Dynamic hybrid pathfinding (see DHP)	

E

EC9540 (license)	4, 7
E-mail address	57
Embedder cards	1, 3, 10, 13, 16–17, 23–24, 34, 51
Embedder output	23–25, 27–32, 34
Embedder port	4–5, 14, 16, 41
Embedder ports	46
END command	14
Enumeration drawings	16
envyadmin	7
EO command	6, 16, 18
Europe, contact	57
Expansion cabling	3
Expansion output cards	1, 3–4

F

Fax number	57
FCC statement	iii
Features, DHP	23
Fiber optic connectors	2

Files, initialization	13
Force embedder off	6, 8, 16
Force embedder on	9
Frame type (command)	14
France, contact	57
Free source	13

H

Hardware symbols	v
Hazardous substance	iv
HD video	1, 8
Hours of operation	57
Hybrid I/O	1, 5, 8
HybridCards file	14
HybridCards_xxxx.cfg	14, 35, 51
HybridPorts file	16–17
HybridPorts_xxxx file	46
HybridPorts_xxxx.cfg	14, 35
HybridSVC.log	16

I

I/O cards	2, 49
IANA	8
IN command	16
Initialization files	13
Input port	16
Input, disembedder	27–29
Input, MADI	30–31
Input, mixed	32–34
Internet assigned numbers authority (see IANA)	

L

License	iii, 4, 7
---------	-----------

M

MADI cards	1, 3, 8, 11, 13, 24, 51
MADI input	24, 30–31
MADI input rate	8
MADI output	24, 26–31, 33–34
MADI output rate	8
MADI ports	10, 19
MADI, DIP switch	1
Middle East, contact	57
Miranda, contact	57
Mixed input	32–34
MRC	9–10, 19–20
Multi-level tab	38

N

NP0016-00	18
NP0017-00	18
Numbering, slots	15, 51–52
NV8140	1
NV8144	1–2, 39, 51
NV8280	1–2, 39, 51
NV8500 family routers	1, 4, 37, 39, 51
NV8576	1–2, 39, 52
NV8576-Plus	1–3, 39, 52
NV9000	4, 7, 13, 18, 23
NV9000 configuration	21
NV9000 Control System CD	7
NV9000 restart	21
NV9000 web suite	34, 37
NV9000, restarting	9
NV9000-SE Utilities	9–11, 13, 18–19, 46
NvHybridSVC_(DHP)	22–23, 35

O

Office hours	57
Options tab	39
Ordering, slots	15, 51–52
OUT command	16
Output port	16
Output, embedder	25, 27–32, 34
Output, MADI	26–31, 33–34

P

Pages	
DHP disembedder	40
DHP drawing	42
DHP embedder	41
DHP re-entry	42
Partitions	10
password	7, 37
Phone numbers	57
Port enumeration drawings	16
Ports, DHP	9
Ports, well-known	8, 13–14
Preferences	
disembedder	45
Primary level tab	38
Product limitations	35

R

Restarting DHP	21, 35
Restarting the NV9000	9, 21

Restrictions	iv
Revision, document	iii
RF0272–RF0276	16
RoHS	iv
Router controls table	12–13
Router levels	10
Router status	23

S

Safeguards	iv
Safety notices	iv
Sample initialization files	13, 16
Sample NV9000 configuration	43
Sample NV9000 data	39, 46
Scenarios	5, 24
SD video	1, 8
Section (command)	14
Shuffling, audio	8, 24–25
Slot numbering	15, 51–52
Slot ordering	15, 51–52
Slot type command	14
Software license	iii
Standard I/O	1, 5, 8, 13, 25–27, 29–33
Standard input	4–5, 19, 24
Standard inputs	46–47
Standard output	4–5, 19, 23–24
Stand-by mode	12
Status, router	23
Status, take	24, 35
Support, contact	57
SV0240-00	7
Symbols, meaning	v

T

Tabbed pages	38
Table, router controls	13
Tabs	
DHP	38
multi-level	38
options	39
primary level	38
tielines	38
Take status	24, 35
Takes	23
Technical support	57
Tielines	6, 9, 16
Tielines tab	38
TL command	16, 18

U

United Kingdom, contact 57
Username 7, 37

V

Video, 3Gig 1, 8
Video, HD 1, 8
Video, SD 1, 8
VO command 16, 18

W

Warnings 9
Warnings, hardware v
Warranty iii
Web site 57
Web Suite 37
Web suite 34
WECO quick-release connectors 2
Well-known ports 8, 13–14



Grass Valley Technical Support

For technical assistance, please contact the Grass Valley Technical Support center nearest you:

Americas

Office hours: 9:00 a.m. – 9:00 p.m. (EST)
Telephone: +1-800-547-8949
 +1 530 478 4148
Fax: +1-514-335-1614
E-mail: support@grass valley.com

Europe, Middle East, Africa, UK

Office hours: 9:00 a.m. – 6:00 p.m. (GMT)
Telephone: +44 118 952 3444
Fax: +44 118 952 3401
E-mail: eurotech@grass valley.com

Playout Automation — Europe, Middle East, Africa, UK

Office hours: 9:00 a.m. – 5:30 p.m. (GMT)
Telephone: +44 870 500 4350
Fax: +44 870 500 4333
automationsupport@grassvalley.com

France

Office hours: 9:00 a.m. – 5:00 p.m. (GMT+1)
Telephone: +33 1 55 86 87 88
Fax: +33 1 55 86 00 29
E-mail: eurotech@grass valley.com

Corporate Head Office

Grass Valley
3499 Douglas-B.-Floreni
St-Laurent, Quebec H4S 2C6
Canada
Telephone: +1 514 333 1772
Fax: +1 514 333 9828
Web: www.grass valley.com

Asia

Office hours: 9:30 a.m. – 6:00 p.m. (GMT+8)
Telephone: +852 2539 6987
Fax: +852 2539 0804
E-mail: asiotech@grass valley.com

China

Office hours: 9:30 a.m. – 6:00 p.m. (GMT+8)
Telephone: +86 10 5873 1814
E-mail: asiotech@grass valley.com

Malaysia

Telephone: +60 3 2247 1808
E-mail: asiotech@grass valley.com

EMERGENCY after hours (global)

Toll free: 1-800-547-8949 (US and Canada)
Telephone: +1 514 333 1772
 +1 530 478 4148

