

NV8900 Series

MADI Interfaces

User's Guide

UG0056-01

18 Apr 2012



www.miranda.com

Copyright © 2012 by Miranda Technologies

All rights reserved. No part of this manual may be reproduced in any form by photocopy, microfilm, xerography or any other means, or incorporated into any information retrieval system, electronic or mechanical, without the written permission of Miranda Technologies, Inc..

- Document Revision: 1.1
- Document Part Number: UG0056-01
- Software Version: -na-

Change History

Rev.	Date	ECO	Description	Approved
1.0	03 Feb 11	—	Initial release.	D.Cox
1.1	13 Apr 12	18179	Minor corrections. Added the two analog audio models. Format change.	D.Cox

Notice

Due to continued product development, the accuracy of the information in this document may change without notice. The information and intellectual property contained herein is confidential between Miranda and the client and remains the exclusive property of Miranda. If you find any problems in the documentation, please report them to us in writing. Miranda does not warrant that this document is error-free.

FC FCC Statement

This equipment has been tested and found to comply with the limits for a Class A digital device, pursuant to part 15 of the FCC Rules. These limits are designed to provide reasonable protection against harmful interference when the equipment is operated in a commercial environment. This equipment generates, uses, and can radiate radio frequency energy and, if not installed and used in accordance with the instruction manual, may cause harmful interference to radio communications. Operation of this equipment in a residential area is likely to cause harmful interference in which case the user will be required to correct the interference at his own expense.

CE Declaration of Conformance (CE)

All of the equipment described in this manual has been designed to conform with the required safety and emissions standards of the European Community. Products tested and verified to meet these standards are marked as required by law with the CE mark.

When shipped into member countries of the European Community, this equipment is accompanied by authentic copies of original Declarations of Conformance on file in Miranda USA offices in Grass Valley, California USA.

Trademarks

Miranda is a registered trademark of Miranda Technologies, Inc.

Brand and product names mentioned in this manual may be trademarks, registered trademarks or copyrights of their respective holders. All brand and product names mentioned in this manual serve as comments or examples and are not to be understood as advertising for the products or their manufactures.

Software License Agreement and Warranty Information

Contact Miranda for details on the software license agreement and product warranty.

Important Safeguards and Notices

This section provides important safety guidelines for operators and service personnel. Specific warnings and cautions appear throughout the manual where they apply. Please read and follow this important information, especially those instructions related to the risk of electric shock or injury to persons.

WARNING

Any instructions in this manual that require opening the equipment cover or enclosure are for use by qualified service personnel only. To reduce the risk of electric shock, do not perform any service other than that contained in the operating instructions unless you are qualified to do so.

Restriction on Hazardous Substances (RoHs)

Miranda is in compliance with EU Directive RoHS 2002/95/EC governing the restricted use of certain hazardous substances and materials in products and in our manufacturing processes.

Miranda has a substantial program in place for RoHS compliance that includes significant investment in our manufacturing process, and a migration of Miranda product electronic components and structural materials to RoHS compliance.

It is our objective at Miranda GVD to maintain compliance with all relevant environmental and product regulatory requirements. Detailed information on specific products or on the RoHS program at Miranda is available from Miranda Customer Support at

1-800-719-1900 (toll-free) or
1-530-265-1000 (outside the U.S.).

Symbols and Their Meanings



The lightning flash with arrowhead symbol within an equilateral triangle alerts the user to the presence of dangerous voltages within the product's enclosure that may be of sufficient magnitude to constitute a risk of electric shock to persons.



The exclamation point within an equilateral triangle alerts the user to the presence of important operating and maintenance/service instructions.



The ground symbol represents a protective grounding terminal. Such a terminal must be connected to earth ground prior to making any other connections to the equipment.



The fuse symbol indicates that the fuse referenced in the text must be replaced with one having the ratings indicated.



The presence of this symbol in or on Miranda equipment means that it has been designed, tested and certified as complying with applicable Underwriter's Laboratory (USA) regulations and recommendations.



The presence of this symbol in or on Miranda equipment means that it has been designed, tested and certified as essentially complying with all applicable European Union (CE) regulations and recommendations.

General Warnings

A warning indicates a possible hazard to personnel which may cause injury or death. Observe the following general warnings when using or working on this equipment:

- Heed all warnings on the unit and in the operating instructions.
- Do not use this equipment in or near water.
- This equipment is grounded through the grounding conductor of the power cord. To avoid electrical shock, plug the power cord into a properly wired receptacle before connecting the equipment inputs or outputs.
- Route power cords and other cables so they are not likely to be damaged.
- Disconnect power before cleaning the equipment. Do not use liquid or aerosol cleaners; use only a damp cloth.
- Dangerous voltages may exist at several points in this equipment. To avoid injury, do not touch exposed connections and components while power is on.
- Do not wear rings or wristwatches when troubleshooting high current circuits such as the power supplies.
- To avoid fire hazard, use only the specified fuse(s) with the correct type number, voltage and current ratings as referenced in the appropriate locations in the service instructions or on the equipment. Always refer fuse replacements to qualified service personnel.
- To avoid explosion, do not operate this equipment in an explosive atmosphere.
- Have qualified service personnel perform safety checks after any service.

General Cautions

A caution indicates a possible hazard to equipment that could result in equipment damage. Observe the following cautions when operating or working on this equipment:

- When installing this equipment, do not attach the power cord to building surfaces.
- To prevent damage to equipment when replacing fuses, locate and correct the problem that caused the fuse to blow before re-applying power.
- Use only the specified replacement parts.
- Follow static precautions at all times when handling this equipment.
- This product should only be powered as described in the manual. To prevent equipment damage, select the proper line voltage on the power supply(ies) as described in the installation documentation.
- To prevent damage to the equipment, read the instructions in the equipment manual for proper input voltage range selection.
- Some products include a backup battery. There is a risk of explosion if the battery is replaced by a battery of an incorrect type. Dispose of batteries according to instructions.
- Products that have (1) no on/off switch and (2) use an external power supply must be installed in proximity to a main power output that is easily accessible.

toc

Table of Contents

1 Preface	1
Chapter Structure	1
The PDF Document	1
Terms, Conventions and Abbreviations	2
2 NV8900	3
AES Interfaces	3
Functions	4
Rates	4
Configuration	4
Operation	4
Analog Audio Interfaces	5
Analog Audio to MADl Interface	6
Function	6
Other LEDs	6
Signal Connectors	7
DIP Switches	7
MADl to Analog Audio Interface	8
Function	8
Other LEDs	8
Connectors	9
DIP Switches	9
Installation	10
AES Interfaces	10
Analog Audio Interfaces	10
3 Misc. Topics	11
Package Contents	11
Installation	11
Obtaining Software and Documentation	13
Maintenance	13
Channel Numbering	13
Audio Rates	13
4 Specifications	15
Power Specifications	15
Reference Specifications	16
Physical Specifications	17
Environmental Specifications	18
Audio Specifications	18
Connectors	19
Serial Connector	19
Balanced AES Connectors	20
Analog Audio Connectors	20

Table of Contents

Power Cord Retention 20
Drawings 21

Index 29

1

Preface

Chapter 1 provides an introduction to the NV8900 Series User's Guide.

Topics

Chapter Structure	1
The PDF Document	1
Terms, Conventions and Abbreviations	2

Chapter Structure

The following chapters provide information regarding the NV8900 MADI Interface:

- Chapter 1, [Preface](#), (this chapter) tells you how to use this guide.
- Chapter 2, [NV8900](#), describes the NV8900, from a user's standpoint and from a technical standpoint.
- Chapter 3, [Misc. Topics](#), provides a connection, maintenance, and other information.
- Chapter 4, [Specifications](#), presents the electrical, mechanical, and other specifications for the NV8900.

An [Index](#) is also available for your reference.

The PDF Document

This guide is provided in PDF format, allowing you to use Acrobat's "bookmarks" to navigate to any desired location. You can also easily print a hardcopy. Please note:

- Use the Table of Contents or the bookmarks page to jump to any desired section.
- Many hyperlinks are provided within the chapters.
- Use the Index to jump to specific topics within a chapter. Each page number in the index is a hyperlink.
- Use Acrobat's 'Go to Previous View' and 'Go to Next View' buttons to retrace your complete navigational path.

Use the 'First Page', 'Previous Page', and 'Next Page', and 'Last Page' buttons to go to the first, previous, next, or last page within a PDF file.

Note

To display the navigation buttons, right-click the Tool Bar area, and check 'Navigation'.

- Use Acrobat's extensive search capabilities, such as the 'Find' tool and 'Search' tool to perform comprehensive searches as required.

Terms, Conventions and Abbreviations

The following conventions are used throughout this guide:

- The symbol ▲ denotes either an example or a special message.
- Entries enclosed in single quotes denote the names of control panel buttons and knobs, or menu items.

Choose 'Aux' to ...

Press 'Keyer 2' button ...

Chapter 2 provides a functional description of the NV8900 Series interfaces.

Topics

AES Interfaces	3
Analog Audio Interfaces	5
Installation	10

The NV8900 product family includes 6 MADI interfaces:

- MADI to AES, unbalanced
- MADI to AES, balanced
- MADI to analog audio
- AES to MADI, unbalanced
- AES to MADI, balanced
- Analog audio to MADI

▲ By AES we mean AES-3 and by MADI we mean “multi-channel audio digital interface,” governed by standard AES10-2003.

The two analog audio interfaces are quite different from the AES interfaces and are discussed under [Analog Audio Interfaces](#) on page 5.

AES Interfaces

The two MADI-to-AES interfaces are demultiplexers that have one MADI input and 32 AES outputs. The unbalanced outputs use 75Ω BNCs; the balanced outputs use 110Ω shielded twisted pairs on DB25 connectors.

The two AES-to-MADI interfaces are multiplexers that have 32 AES inputs and one MADI output. The unbalanced inputs use 75Ω BNCs; the balanced inputs use 110Ω shielded twisted pairs on DB25 connectors.

The MADI inputs and outputs are 75Ω BNCs.

The AES-to-MADI interfaces accept up to 64 audio channels. The MADI-to-AES interfaces produce 64 audio channels. The individual MADI channels are paired on the AES inputs or outputs. AES connector 1 corresponds to MADI channels 0 and 1; AES connector 2 corresponds to MADI channels 2 and 3, and so on. AES connector 32 corresponds to MADI channels 62 and 63.

The AES interfaces are 1RU and about 2” in depth. The following photographs are representative:

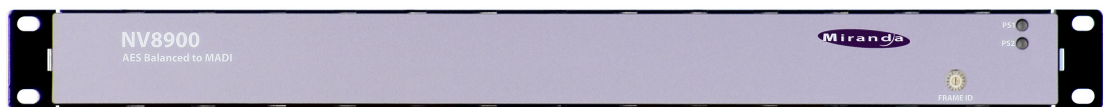

This is a front view of the AES (balanced) to MADI interface. The other AES units resemble this one, where the difference between the models is the legend.

This is a rear view of the AES (balanced) to MADl interface:



It has 4 DB25 connectors supporting the AES inputs. The MADl to AES (balanced) interface is similar, except for the legend.

This is a rear view of the AES (coax) to MADl interface:



Here, there are 32 BNC connectors supporting the AES inputs. Here, too, the MADl to AES (coax) interface is similar, except for the legend.

Functions

The AES models convert discrete AES signal pairs to MADl format or vice versa.

The MADl-to-AES interfaces interpret the incoming framing data and preserve VUCP data.

The AES-to-MADl interfaces preserve VUCP and also generate the framing data (in the first 4 bits of each MADl subframe).

Each interface has a video reference input (loop-through). Each interface has a serial port (DE9) that is reserved for future use. Each interface has an Ethernet port (RJ-45) for a connection to MRC (the Miranda Router Configurator).

Each interface has two power connectors (for PS0001 power supply) and a grounding terminal.

Rates

The MADl interfaces send and receive AES at exactly 48.0kHz (samples per second).

Configuration

You can use MRC (Miranda Router Configurator) to change an NV8900's IP address and also to upload firmware.

The NV8900 has a 16-position rotary switch (Frame ID) on the front. This switch exists so that different NV8900 frames can be distinguished (by MRC) on a network. The switch is not required for operation.

Operation

The NV8900 AES interfaces function on their own and do not require an operator.

It is sufficient to rack-mount the devices and connect cables to your inputs and outputs.

Analog Audio Interfaces

The NV8900 analog audio interfaces are larger, and more complex than, the AES interfaces and provide a number of status LEDs:



The MADI-to-analog-audio interface is a demultiplexer that has two MADI inputs and 64 analog audio outputs (32 pairs). The outputs use 110 Ω shielded twisted pairs on DB25 connectors.

The MADI-to-analog-audio interface interprets the incoming framing data and preserve VUCP data.

The analog-audio-to-MADI interface is a multiplexer that has 64 analog audio inputs (32 pairs) and two MADI outputs. The inputs use 110 Ω shielded twisted pairs on DB25 connectors.

The analog-audio-to-MADI interfaces preserve VUCP and also generate the framing data (in the first 4 bits of each MADI subframe).

The MADI inputs and outputs are 75 Ω BNCs.

The analog-audio-to-MADI interface accepts 64 audio channels. The MADI-to-analog-audio interface produces 64 audio channels. The MADI channels are paired on the AES inputs or outputs. AES connector 1 corresponds to MADI channels 0 and 1; AES connector 2 corresponds to MADI channels 2 and 3, and so on. AES connector 32 corresponds to MADI channels 62 and 63.

Each unit has a video reference input (loop-through). Each interface has a serial port (DE9) that is reserved for future use. Each interface has an Ethernet port (RJ-45) for a connection to MRC (the Miranda Router Configurator).

Each unit has two power connectors (for PS0001 power supply) and a grounding terminal.

Each unit is 1RU and 17" in depth.

Analog Audio to MADI Interface

This is a front view of the analog-audio-to-MADI interface:

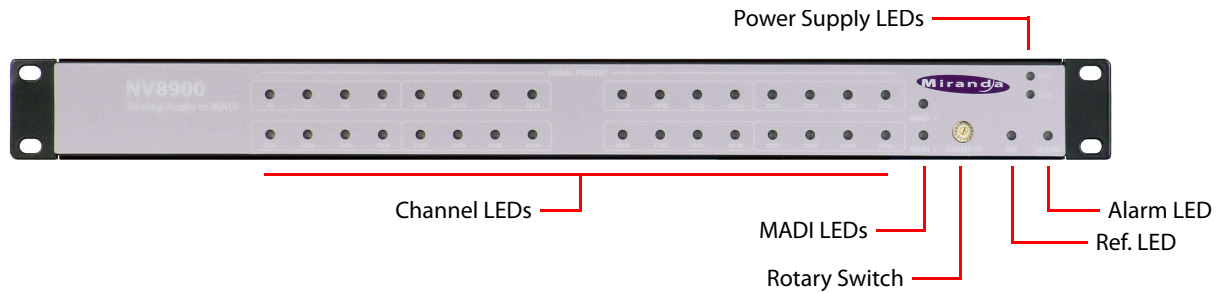

This is a rear view of the analog-audio-to-MADI interface:

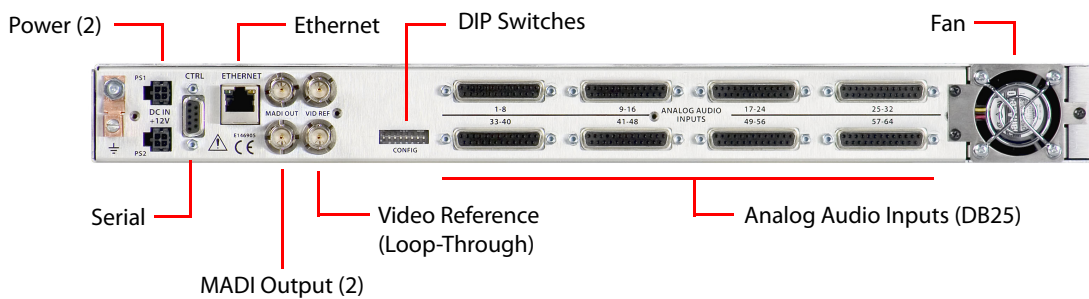

Function

The AA-to-MADI interface receives 64 analog audio inputs and produces two MADI outputs, both identical. The second output is for redundancy.

The 64 inputs are paired internally and are represented by 32 LEDs at the front of the panel, one for each pair. Each of these LEDs acts as a primitive level meter for the pair, according to the following scale:

LED state	Audio Level Range
Off	< -50 dBfs
Green	-50 to -4 dBfs
Red	> -4 dBfs to 0 dBfs

The unit accepts video reference. It derives its internal clocks from the video reference. It can free-run, but it is advisable to use an external reference, especially when used with an NV8500 hybrid router.

Other LEDs

Each MADI output is represented by an LED at the front of the unit. The LED is green when the MADI output is good. Otherwise, the LED is off.

The reference signal is represented by an LED. This LED is green when the reference is good and red when it is not.

An alarm LED is off under normal operation but turns red for the following conditions:

- Overtemperature
- MADI output failure
- Reference is bad or missing

Signal Connectors

At the rear of the AA-to-MADI interface are signal connectors. There are 2 MADI outputs (BNCs), two video reference connectors (BNC, loop-through), and 8 DB25s for analog audio input.

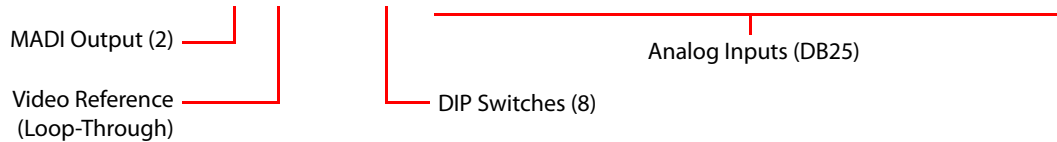
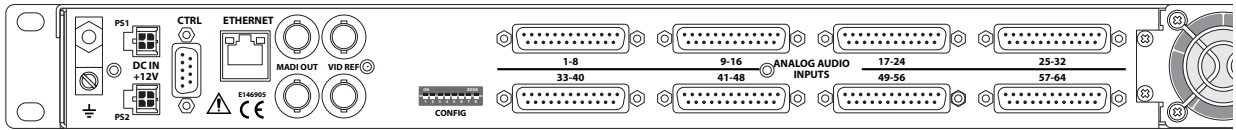

Each DB25 supports 8 analog audio inputs. The 8 inputs on a connector correspond to an enclosed section of the labeling on the front of the unit. For instance, first DB25 connector is for inputs 1 through 8 and the corresponding markings on the front of the unit are pair 1/2, 3/4, 5/6, and 7/8.

The power connectors, serial port, and Ethernet port are described under [Installation](#) on page 11.

Each power connection is represented by an LED at the front of the unit. When the LED is green, its power supply circuit is good. If the LED is off, the power supply is bad.

The MADI outputs are identical.

The video reference connectors are “loop-through” allowing you to “daisy-chain” a reference signal to multiple devices. See [Reference Specifications](#) on page 16.

DIP Switches

There are 8 DIP switches in a recess at the rear of the unit:

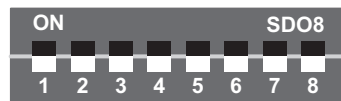

CONFIG

The first 3 switches control the overall audio level of the unit:

Switch				Switch			
3	2	1	Level	3	2	1	Level
0	0	0	+24 dBu	1	0	0	+16 dBu
0	0	1	+22 dBu	1	0	1	+14 dBu
0	1	0	+20 dBu	1	1	0	+12 dBu
0	1	1	+18 dBu	1	1	1	+10 dBu

Switches 4–7 are reserved for future use.

Switch 8 is for factory testing. Leave it off.

MADI to Analog Audio Interface

This is a front view of the MADI-to-analog-audio interface:

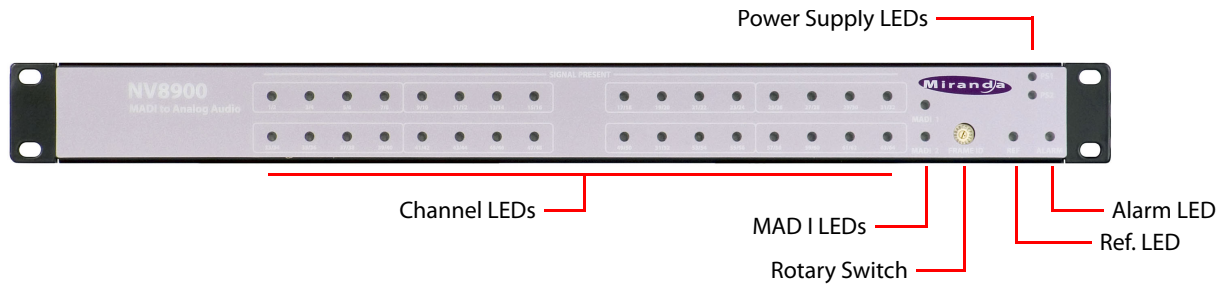

This is a rear view of the MADI-analog-audio interface:

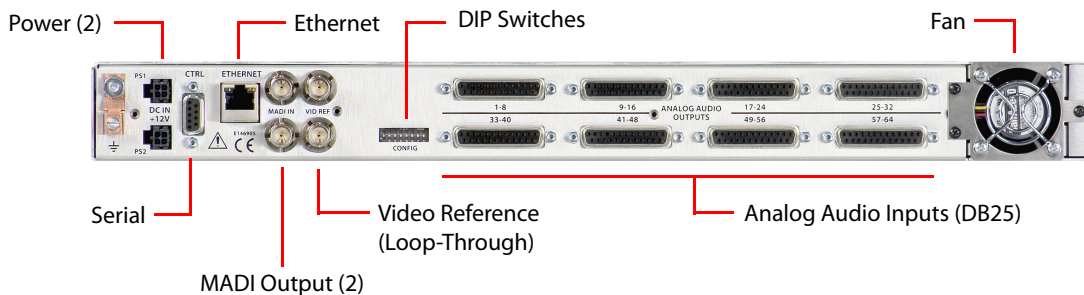

Function

The MADI-to-AA interface accepts one or two MADI input streams. If it receives two MADI signals (for redundancy), they should be identical. Only one of the MADI streams is active. The other if it is present, is stand-by. The stand-by input becomes active if the active input fails.

- ▲ A failure occurs when there 1 or more bit errors per second for 3 or more seconds.

The unit extracts 64 audio channels From the active MADI stream.

The 64 outputs are paired internally and are represented by 32 LEDs at the front of the panel, one for each pair. Each of these LEDs acts as a primitive level meter for the pair, according to the following scale:

LED state	Audio Level Range
Off	< -50 dBfs
Green	-50 to -4 dBfs
Red	> -4 dBfs to 0 dBfs

The unit accepts video reference. It derives its internal clocks from the video reference. It can free-run, but it is advisable to use an external reference, especially when used with an NV8500 hybrid router.

Other LEDs

Each MADI input is represented by an LED at the front of the unit. The color of the LED represents the state of the MADI input:

- Green — the MADI input is good and active.
 - Amber (or orange) — the MADI input is good and stand-by (inactive).
 - Red — the MADI input is bad.
- ▲ These LEDs behave differently from those of the AA-to-MADI interface.

The reference signal is represented by an LED. This LED is green when the reference is good and red when it is not.

An alarm LED is off under normal operation but turns red for the following conditions:

- Overtemperature
- MADI output failure
- Reference is bad or missing

Connectors

At the rear of the MADI-to-AA interface are signal connectors. There are 2 MADI outputs (BNCs), two video reference connectors (BNC, loop-through), and 8 DB25s for analog audio input.

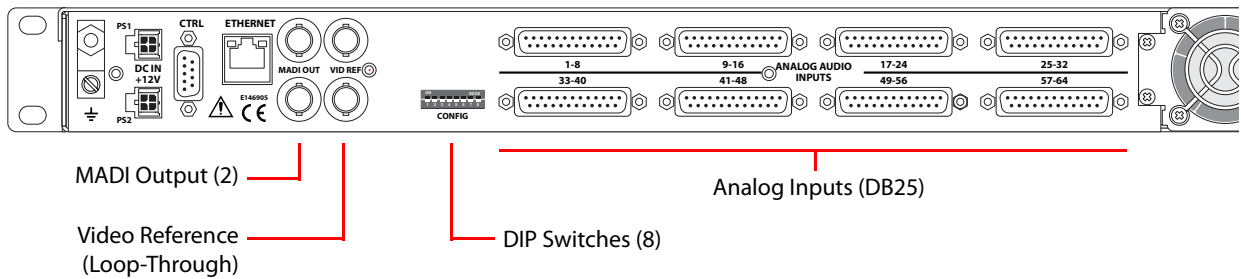

Each DB25 supports 8 analog audio outputs. The 8 outputs of a connector correspond to an enclosed section of the labeling on the front of the unit. For instance, first DB25 connector is for outputs 1–8 and the corresponding markings on the front of the unit are pair 1/2, 3/4, 5/6, and 7/8.

The power connectors, serial port, and Ethernet port are described under [Installation](#) on page 11.

Each power connection is represented by an LED at the front of the unit. When the LED is green, its power supply circuit is good, and when the LED is off, the power supply circuit is bad.

The MADI inputs are identical.

The video reference connectors are “loop-through” allowing you to “daisy-chain” a reference signal to multiple devices. See [Reference Specifications](#) on page 16.

DIP Switches

There are 8 DIP switches in a recess at the rear of the unit:

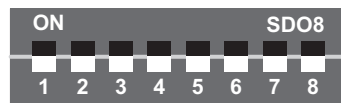

CONFIG

The first 3 switches control the overall audio level of the unit:

Switch				Switch			
3	2	1	Level	3	2	1	Level
0	0	0	+24 dBu	1	0	0	+16 dBu
0	0	1	+22 dBu	1	0	1	+14 dBu
0	1	0	+20 dBu	1	1	0	+12 dBu
0	1	1	+18 dBu	1	1	1	+10 dBu

Switches 4–7 are reserved for future use.
Switch 8 is for factory testing. Leave it off.

Installation

AES Interfaces

The AES interfaces are small and lightweight. It is sufficient to mount them in a 19" rack with suitable screws.

Analog Audio Interfaces

The analog audio interfaces are large and somewhat heavy and require special hardware that attaches to, and supports, the rear of the units. There are two metal pieces for each side of the NV8900:

- ME1714-xx—an 8" extension plate, with screw holes, that attaches to the side of the NV8900.
- ME1745-xx—a small (1.72") metal plate that attaches to the rear frame posts.

The extension plates fit in the slots of the small plate, and the small plate supports the weight of the NV8900, as shown:

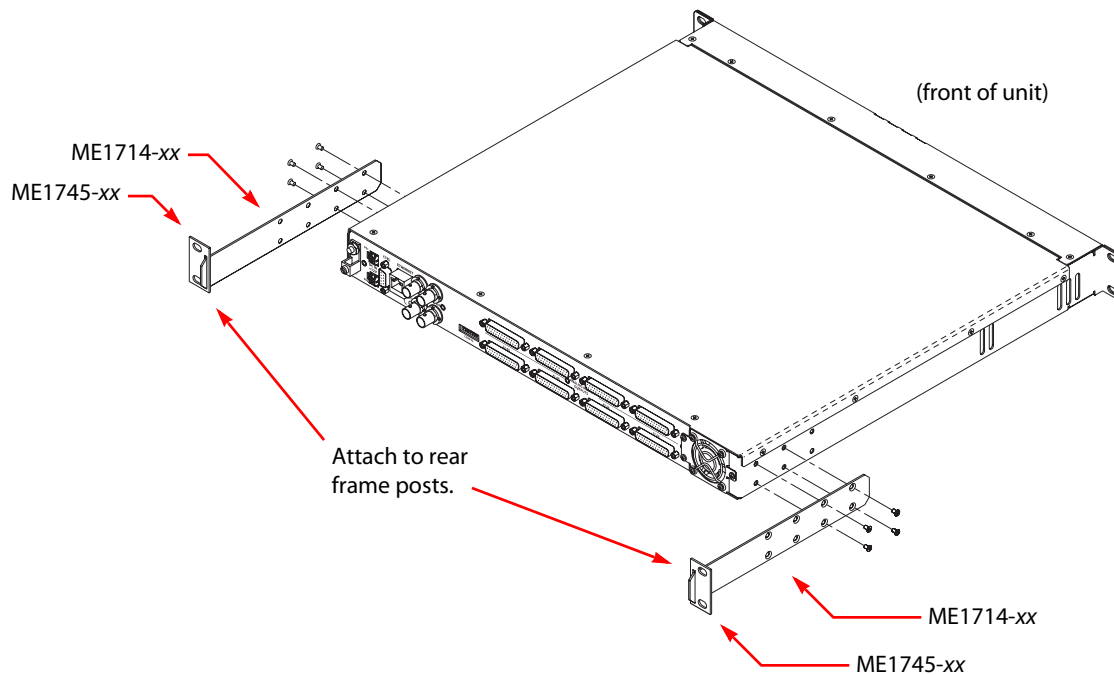

The (4) metal plates, and screws, are attached to the NV8900 during shipment. Keep them in a safe place until you are ready to install the NV8900.

The extension plates provide an additional 6.3" of depth, for a total extension of 22.64". You can adjust the position of the plate if your rack has less depth.

If your rack does not have rear posts, or if your rack is deeper than 22.64", consider mounting the NV8900 just above another device in the rack (say, a router). The other device then supports the NV8900. Place a non-metal spacer (0.03") between the NV8900 and the other device.

3

Misc. Topics

Chapter 3 provides the following:

Topics

<i>Package Contents</i>	11
<i>Installation</i>	11
<i>Obtaining Software and Documentation</i>	13
<i>Maintenance</i>	13
<i>Channel Numbering</i>	13
<i>Audio Rates</i>	13

Package Contents

If you have ordered one or more NV8900 products from Miranda, inspect the shipping container for damage. If you find any container damage, unpack and inspect the contents. If the contents are damaged, notify the carrier immediately.

As you unpack the shipping container, look for the packing slip and compare it against the contents to verify that you received everything as ordered. If anything is missing (or if you find equipment damage unrelated to shipping), please contact technical support. Refer to [Technical Support Contact Information](#) on page iii.

Depending on your order, the NV8900 items that can ship include:

- One or more NV8900 devices.
- One or more power supplies (PS0001) with power cord retention straps.

The package does not contain network cables, serial cables, or mounting screws.

You do not need to take any special precautions regarding ESD.

This document does not address the shipment or installation of any other equipment or software that can be used in conjunction with the NV8900 (including the NV9000 system controller, NV915 system controller, and configuration programs such as MRC or NV9000-SE Utilities).

This document does briefly address the use of MRC as it pertains to setting the interfaces' IP addresses.

Installation

The NV8900 interface(s) are designed to mount in a standard 19" equipment rack. This is not a requirement, but we assume a 19" rack for the sake of simplicity.

Follow these steps to install an NV8900 interface:

- 1 Set the position of the 16-position rotary switch on the front of the interface.
Set the switch to any *non-zero* position.

Although the switch is not used at present, in the future MRC will use the switch position to distinguish multiple NV8900s on an Ethernet LAN.

Use a small screwdriver to turn the rotary switch.

- ▲ In a network, all devices must have unique IP addresses. An IP address is determined (at least initially) by the rotary switch at the front of the MADi interface. The rotary switches must (at least initially) be distinct.

2 Mount, and secure, the MADi interface in the rack.

For the 1RU interfaces, the mounting holes are spaced 1.25" (31 mm) vertically and allow approximately 1/8" (3 mm) of movement horizontally.

For the 2RU interfaces, the 3 mounting holes on each side are spaced 1.25" (31 mm) and 1.75" (44 mm) (3", 76 mm, overall) vertically and allow approximately 1/8" (3 mm) of play horizontally.

- ▲ You might not have enough space to reach behind the MADi interface and make connections. In that case, leave this step until last.

3 If you are using the MADi interface on a network (for MRC), connect an Ethernet cable (RJ-45) from the network switch to the Ethernet port of the MADi interface. Also connect an Ethernet cable from your PC running MRC to the Ethernet switch.

4 Connect your video reference.

Each MADi interface has two video reference BNC connectors. You can connect a reference source to either one. You can "daisy chain" the output of one reference connector to the input of another. The output of the last connector in the series should be terminated with a 75Ω BNC terminator.

Your MADi interfaces must use the same video reference as your router (especially an NV8500 family hybrid router).

5 Optionally connect the ground lug to earth ground. Use copper wire from 14 to 6 AWG. Grounding decisions are left to you or your facilities manager. Failure to connect the ground will not affect normal operation, but connecting the ground will protect you and your equipment in a power anomaly such as a lightning strike.

6 Connect one or both power supplies. First connect the 4-pin connector to PS1 or PS2 on the rear of the router. The connectors are keyed and snap into place. There is only one way they fit. Do not force them. Then connect the power supply to AC power.



The second power connection is for redundancy only (protection against failure) and is not a requirement for operation.

7 Connect input devices and output devices. No particular order or combination is required.

Some of the MADi interfaces use standard 75Ω BNC connectors.

Some of the MADi interfaces use DB25 connectors. You can obtain DB25 breakout cables from Miranda or build your own cables. (The Miranda part number is WC0053.)

Obtaining Software and Documentation

This document is available through the Miranda web site.

Maintenance

The NV8900 requires no maintenance.

Channel Numbering

The MAD I interfaces support 64 audio channels, 0–63. The MAD I channels are paired on the AES inputs or outputs:

MAD I channel m corresponds to AES port p thus:

$$\begin{aligned} p &= \lfloor m/2 \rfloor + 1 & 0 \leq m \leq 63. \\ m_1 &= p \times 2 - 2 & 1 \leq p \leq 32. \\ m_2 &= p \times 2 - 1 \end{aligned}$$

▲ The MAD I channels are numbered 1–64 in NV9000-SE Utilities.

Audio Rates

According to the MAD I specification, MAD I receivers and drivers operate at 125 MHz which supports 100M bits per second under 4B5B encoding. The receivers expect and the drivers produce 64 audio channels at exactly 48 kHz. The 64 channels consume 98,304,000 bps with a 1.7% margin for sync symbols and padding.

At least one sync symbol must accompany every MAD I frame. The minimal number of sync symbols is 48,000 per second. At 10 bits per symbol, that is 480,000 bits out of 2,120,000 spare bits.

The AES10-2003 specification's tolerance on the transmission rate is 100 ppm (10^{-4}). Thus the rate must be $125 \text{ MHz} \pm 12,500 \text{ kHz}$.

▲ Our MAD I interfaces send and receive AES at 48.0kHz exactly. The data rate is, of course, affected by the actual transmission rate. The effect on a 48 kHz data rate is a variance of $\pm 4.8 \text{ Hz}$.

4 Specifications

Chapter 4 provides an introduction to the NV8900 Series User's Guide.

Topics

<i>Power Specifications</i>	15
<i>Reference Specifications</i>	16
<i>Environmental Specifications</i>	18
<i>Physical Specifications</i>	17
<i>Audio Specifications</i>	18
<i>Connectors</i>	19
<i>Power Cord Retention</i>	20
<i>Drawings</i>	21

Power Specifications

NV8900 AES Power Specifications

These specifications are applicable to the 4 AES models:

- AES-to-MADI, balanced
- AES-to-MADI, coax
- MADI-to-AES, balanced
- MADI-to-AES, coax

Specification	Detail
DC power	External power supply: 12VDC \pm 10%, 5A.
Power consumption	Each device consumes less than 10 Watts.
Regulatory	UL listed and CE compliant.

NV8900 Analog Audio to MADI Power Specifications

Specification	Detail
DC power	External power supply: 12VDC \pm 10%, 5A.
Power consumption	Each device consumes less than 30 Watts.
Regulatory	UL listed and CE compliant.

NV8900 MADI to Analog Audio Power Specifications

This rating is subject to driving loads of 10 k Ω or more.

Specification	Detail
DC power	External power supply: 12VDC \pm 10%, 5A.
Power consumption	Each device consumes less than 45 Watts.
Regulatory	UL listed and CE compliant.

Power Supply Specifications

Specification	Detail
AC power	90–264 VAC (127–300VDC), 47–447 Hz. Inrush current < 50 A at 230VAC, cold start, at 25°C, Input current < 2.0 A rms at 115VAC; < 1.0 A at 230 VAC.
DC power	≤ 60W, 12VDC, 5 A (5.4 A peak), Regulation ± 2%. Ripple ≤ 120 mV.
Efficiency	Efficiency > 80% at full load typical, 115 VAC.
Weight	1.06 lb (0.48 kg).
Regulatory	UL Listed and CE Compliant.

The power supply is an Miranda PS0001-00:

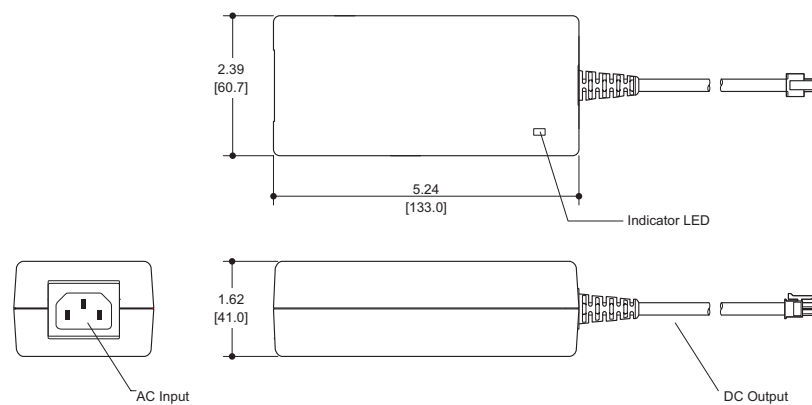

The power output has Molex 4-pin plug. See [Power Cord Retention](#) on page 20.

Reference Specifications

NV8900 Video Reference Specifications.

Detail		
Connectors: 2 BNC (1 pair, loop-through), non-terminating, 75Ω characteristic impedance.		
Acceptable video reference rates:		
NTSC	(30/1.001) Hz frame rate	525 lines/frame
PAL	25 Hz frame rate	625 lines/frame
HD Trilevel	(24/1.001) Hz frame rate	1080p
	24 Hz frame rate	1080p
	25 Hz frame rate	1080i
	(30/1.001) Hz frame rate	1080i
	30 Hz frame rate	1080i
	50 Hz frame rate	1080p, 720p
	(60/1.001) Hz frame rate	1080p, 720p
	60 Hz frame rate	1080p, 720p
Input level range: 500 mV p-p to 2 V p-p		
Input return loss: > 40 dB, to 6 MHz		

Physical Specifications

Specifications for AES Interfaces

Specification	Detail
Dimensions	Height: 1.72" (43.7 mm), fits EIA 1 RU (1.75" or 44.5 mm). Width: 19.0" (482.6 mm). Depth: 1.53 ± 0.01" (38.7 mm), enclosure; 2.19" (55.6 mm) overall, including connectors.
Weight	MADI to AES, balanced: 1.65 lb (0.748 kg) MADI to AES, coax: 2.15 lb (0.977 kg) AES to MADI, balanced: 1.65 lb (0.748 kg) AES to MADI, coax: 2.15 lb (0.977 kg)
Connectors	Power: 2 connectors, Molex 4-pin, keyed. Ethernet: 1 connector, 10/100BaseT, RJ-45 jack. RS-422: 1 connector, 9-pin D type, usage determined by software, SMPTE 207M. Video reference: 2 connectors, BNC, 75Ω. Coax: 35 BNC, 75Ω, connectors. Balanced: 4 DB25, 110Ω, and 3 BNC, 75Ω
Grounding terminal	Copper, accepts 14–6 AWG.

Specifications for Analog Audio Interfaces

Specification	Detail
Dimensions	Height: 1.72" (43.7 mm), fits EIA 1 RU (1.75" or 44.5 mm). Width: 19.0" (482.6 mm). Depth: 1.53 ± 0.01" (38.7 mm), enclosure; 2.19" (55.6 mm) overall, including connectors.
Weight	(Both units) 2.93 kg (6.46 lb)
Connectors	Power: 2 connectors, Molex 4-pin, keyed. Ethernet: 1 connector, 10/100BaseT, RJ-45 jack. RS-422: 1 connector, 9-pin D type, usage determined by software, SMPTE 207M. Video reference: 2 connectors, BNC, 75Ω. MADI: 2 connectors, BNC, 75Ω. Analog audio: 8 DB25, 110Ω
Grounding terminal	Copper, accepts 14–6 AWG.

Environmental Specifications

NV8900 Environmental Specifications.

Specification	Detail
Operating temperature	0–40°C, ambient.
Relative humidity	0 to 90%, non-condensing.
Cooling	No fan required

Audio Specifications

NV8900 AES Coax Specifications.

Specification	Detail
Signal inputs	Signal type: AES-3id (2 “mono” channels per input). Sample rate: 48 kHz. Input level: 1V p-p \pm 20% into 75 Ω . Input range: 320 mVp-p to 1Vp-p into 75 Ω . Input return loss: < –15 dB, from 100 kHz to 6 MHz. Input connectors: BNC, 75 Ω .
Signal outputs	Signal type: AES-3id (2 “mono” channels per input). Sample rate: 48 kHz. Output level: 1 V p-p \pm 20% into 75 Ω . Output return loss: < –15 dB, from 100 kHz to 6 MHz. Output connectors: BNC, 75 Ω .

NV8900 AES Balanced Specifications.

Specification	Detail
Signal inputs	Signal type: AES-3 (2 “mono” channels per input). Sample rate: 48 kHz. Input level: 1Vp-p nominal into 110 Ω . Input range: 200 mVp-p to 10Vp-p into 110 Ω . Input connectors: DB25, 110 Ω .
Signal outputs	Signal type: AES-3 (2 “mono” channels per input). Sample rate: 48 kHz. Output level: 2–7Vp-p into 75 Ω . Output return loss: < –25 dB, from 100 kHz to 6 MHz. Output connectors: BNC, 75 Ω .

NV8900 Analog Audio Specifications **TBD**

Specification	Detail
Signal inputs	Input level: Up to 24dBu. Input impedance: > 20k Ω . Input CMRR: > 75 dBu. Input connectors: DB25.
Signal outputs	Output level: Up to 24dBu (unity gain). Input to output level variations: \pm 1dB, nominal. Frequency response: < \pm 0.05 dB from 20Hz to 100kHz. Output impedance: 50 Ω , nominal. THD and noise: < 0.002%. Crosstalk: > 85 dB, worst case. SNR: > 100dB, relative to +24 dBu (20Hz to 20kHz). Output connectors: DB25.

NV8900 MADI Specifications.

Specification	Detail
Connector	BNC
Impedance	75 Ω
Input level	150 mV to 600 mV
Output level	600 mV

Connectors

Serial Connector

The serial connector for all NV8900 MADI Interfaces has this pinout:

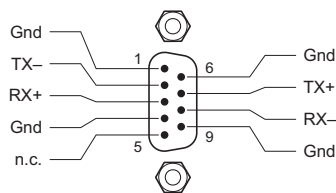

The connector is RS-485, but can be used as RS-422.

However, the port is unused and reserved for future expansion.

Balanced AES Connectors

Balanced AES inputs and outputs use 110Ω DB25 connectors. Each connector supports 8 inputs (or outputs):

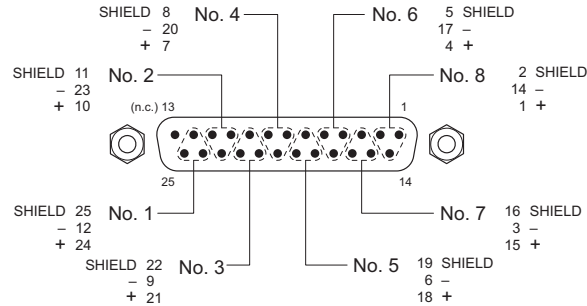

Analog Audio Connectors

Analog audio inputs and outputs use 110Ω DB25 connectors. Each connector supports 8 inputs (or outputs):

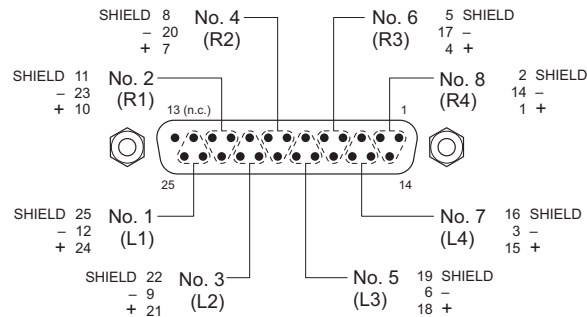

The inputs are paired consecutively:

- (L1,R1) = ports 1 and 2
- (L2,R2) = ports 3 and 4
- (L3,R3) = ports 5 and 6
- (L4,R4) = ports 7 and 8

Power Cord Retention

Use the supplied retention strap to keep the AC power cord firmly connected to the power supply. Follow these steps to use the strap:

- 1 Firmly insert the AC power cord into the power supply. Examine the last figure in this section to see how the strap should be applied.

- 2 Placed the Velcro retention strap, fuzzy side up, on top of the power supply with the buckle loop approximately 1 inch from the AC input side and the remaining strap around the cord end and down:



- 3 Holding the buckle in place, lift the strap up and around the cord end so the strap overlaps itself:



- 4 Holding the buckle loop in place, route the strap around the back of the supply diagonally across so that it sticks out on the left below the output cord:



- 5 Continue the strap around toward the buckle loop and through the loop. Cinch the strap tightly. While keeping tension, place the 2 inch strap end (with Velcro loops) down on the fuzzy part to complete the process:



- 6 Examine the strap though its path around the cord and power supply. Be sure that no slack exists and that it is tight the full length of the strap. If necessary, adjust and cinch it more tightly.

Drawings

Drawings follow on the next few pages.

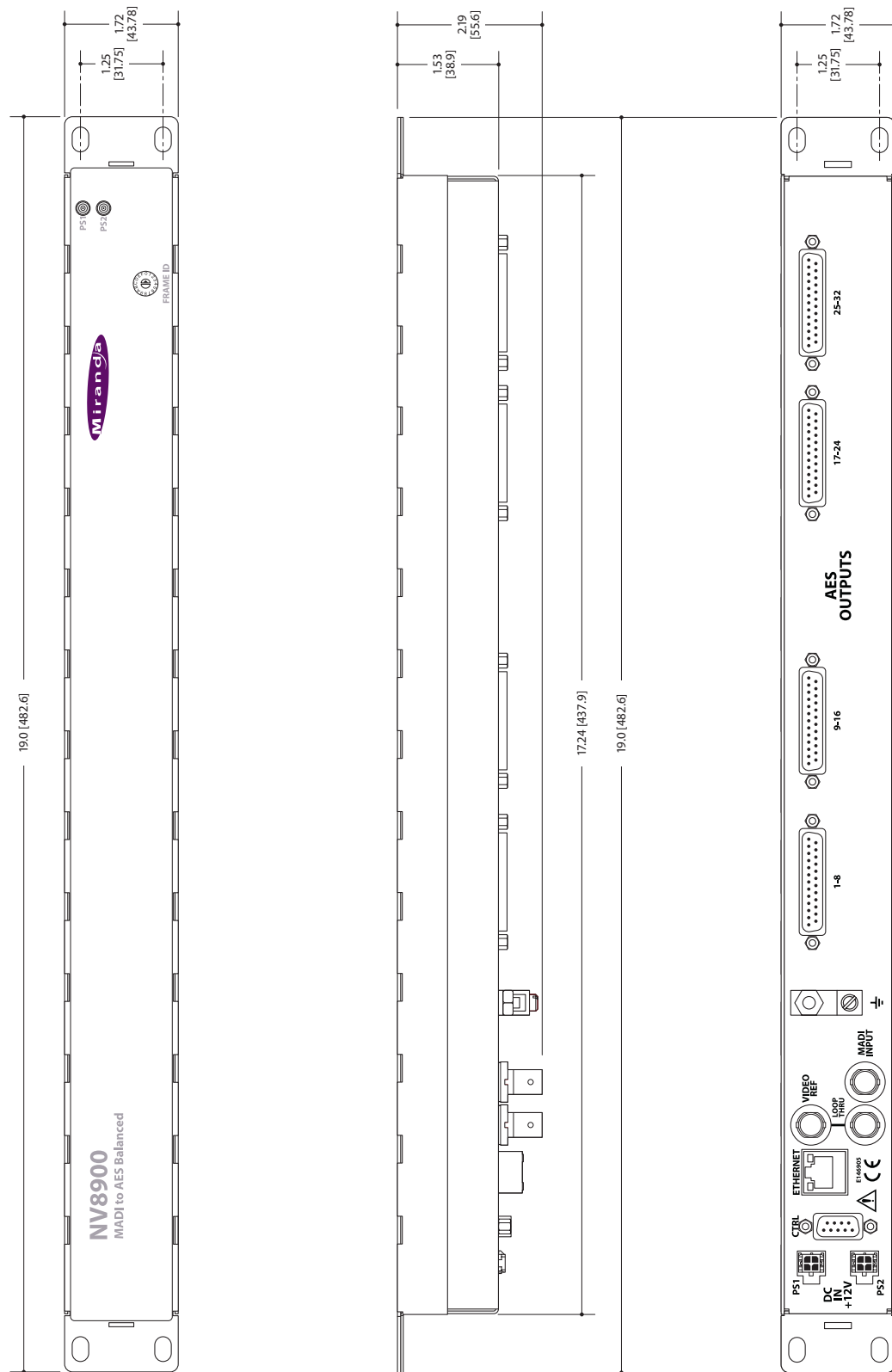

Fig. 4-1: Front, Top, and Rear Views of the Balanced MADI to AES Interface

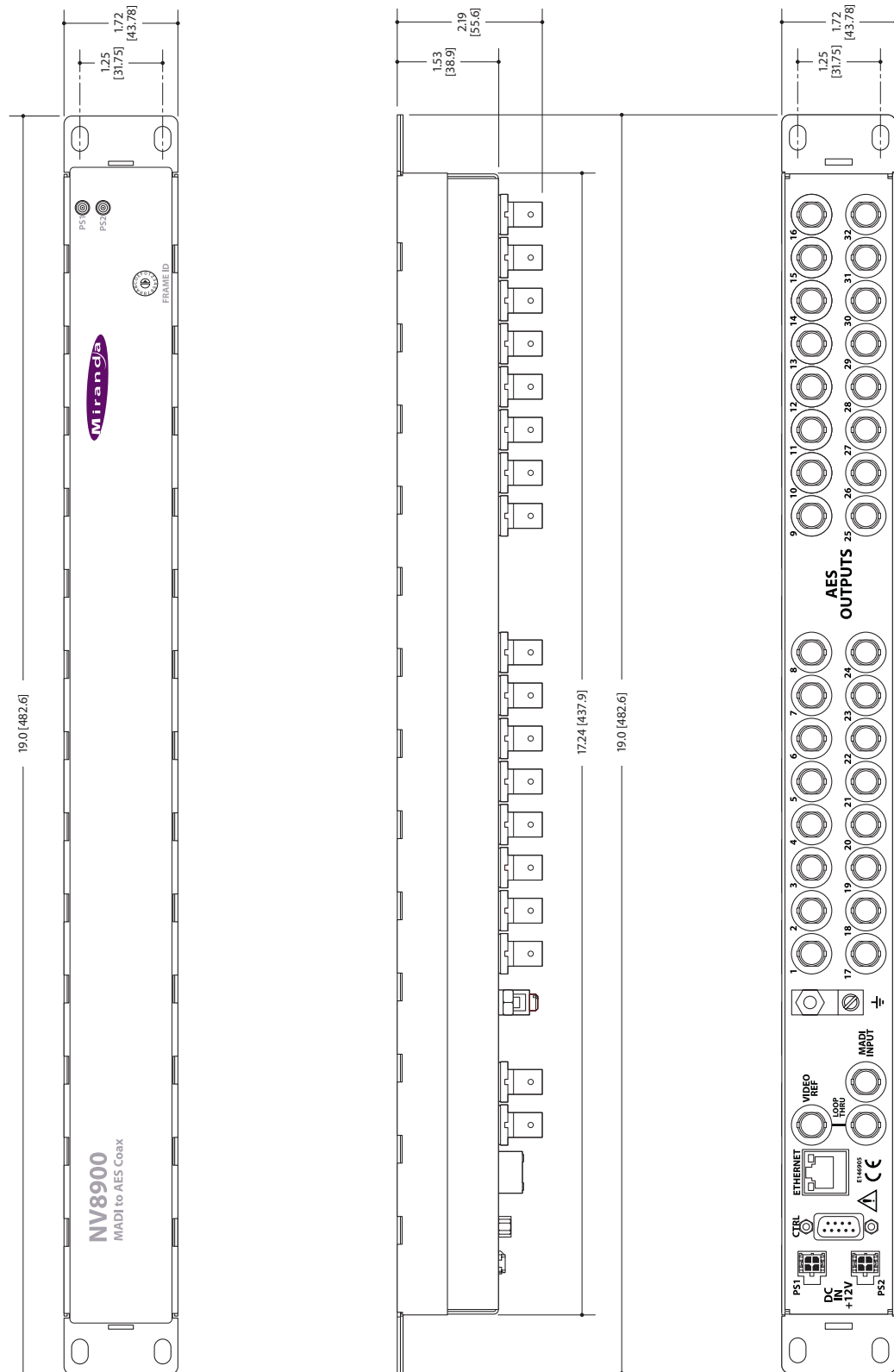

Fig. 4-2: Front, Top, and Rear Views of the Coax MADI to AES Interface

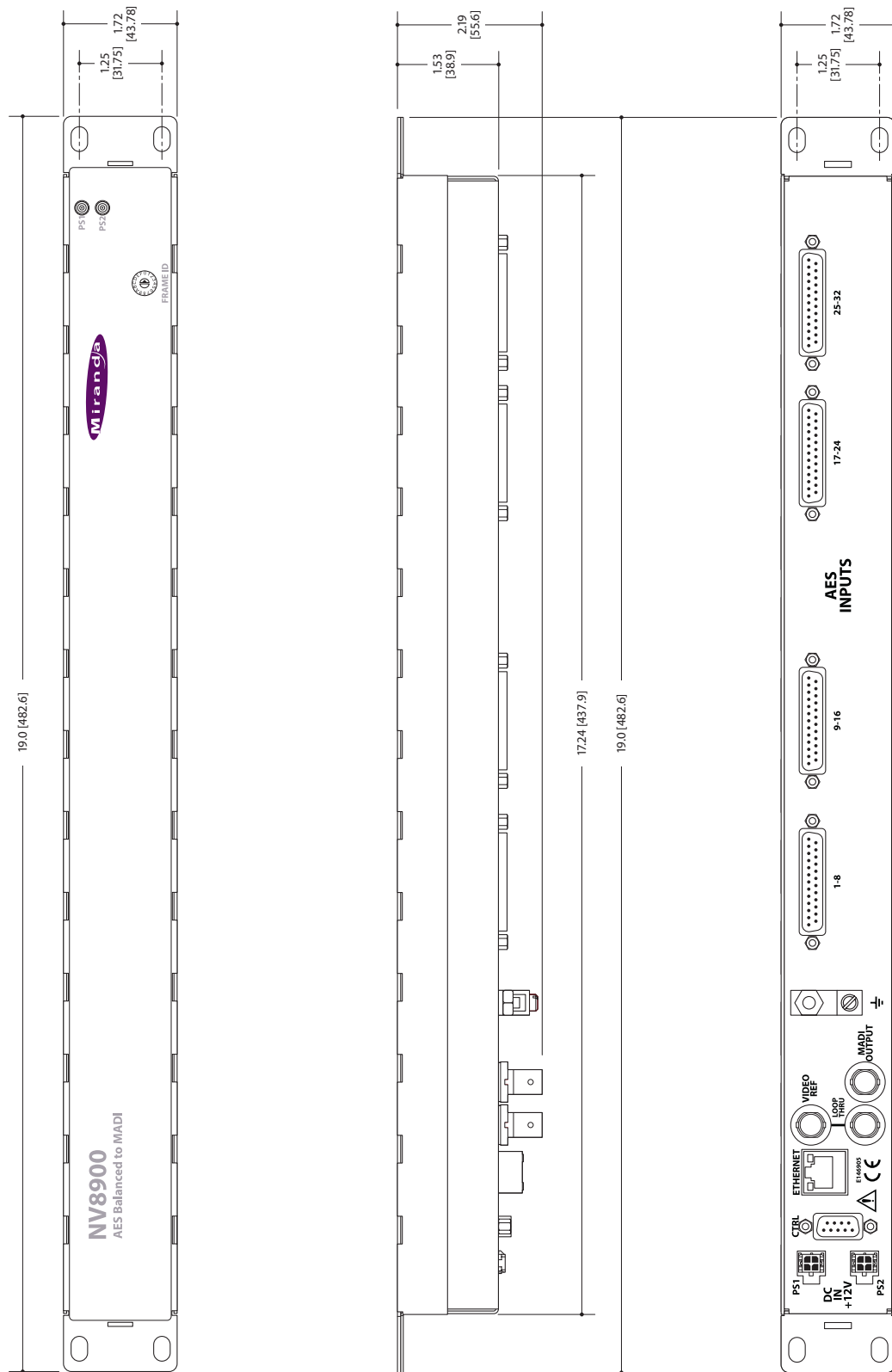

Fig. 4-3: Front, Top, and Rear Views of the Balanced AES to MADI Interface

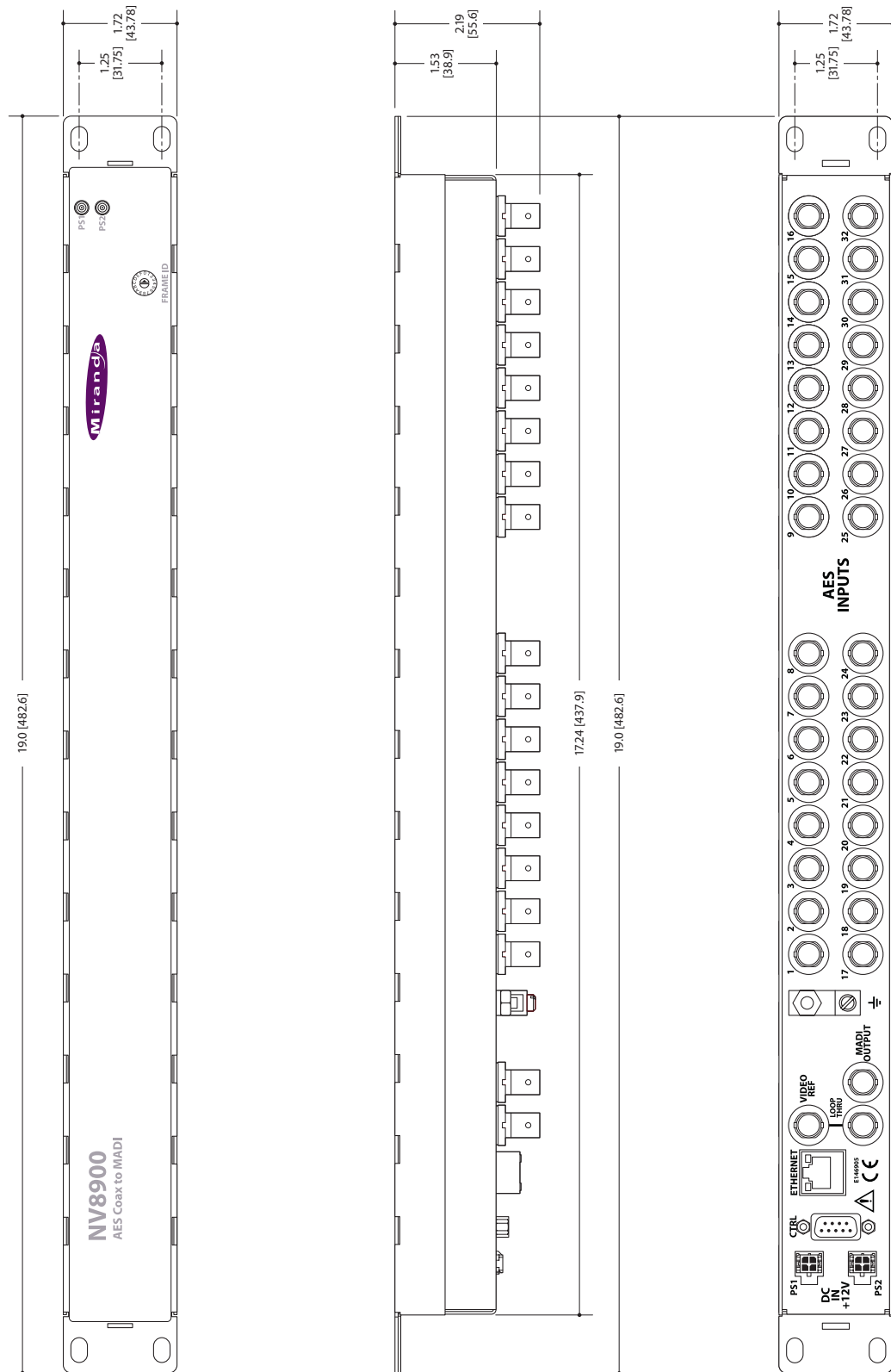

Fig. 4-4: Front, Top, and Rear Views of the Coax AES to MADI Interface

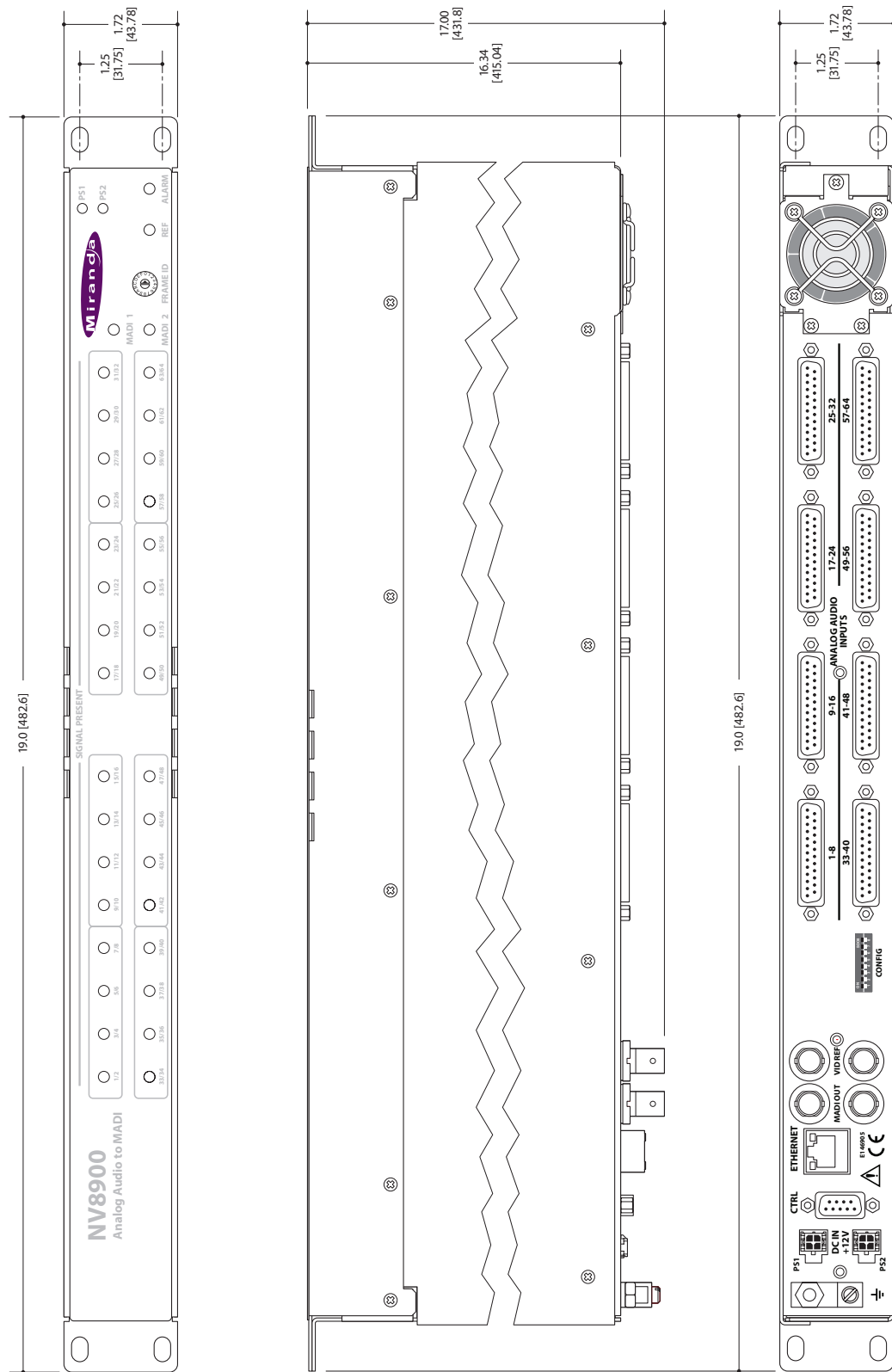

Fig. 4-5: Front, Top, and Rear Views of the Analog Audio to MADI Interface

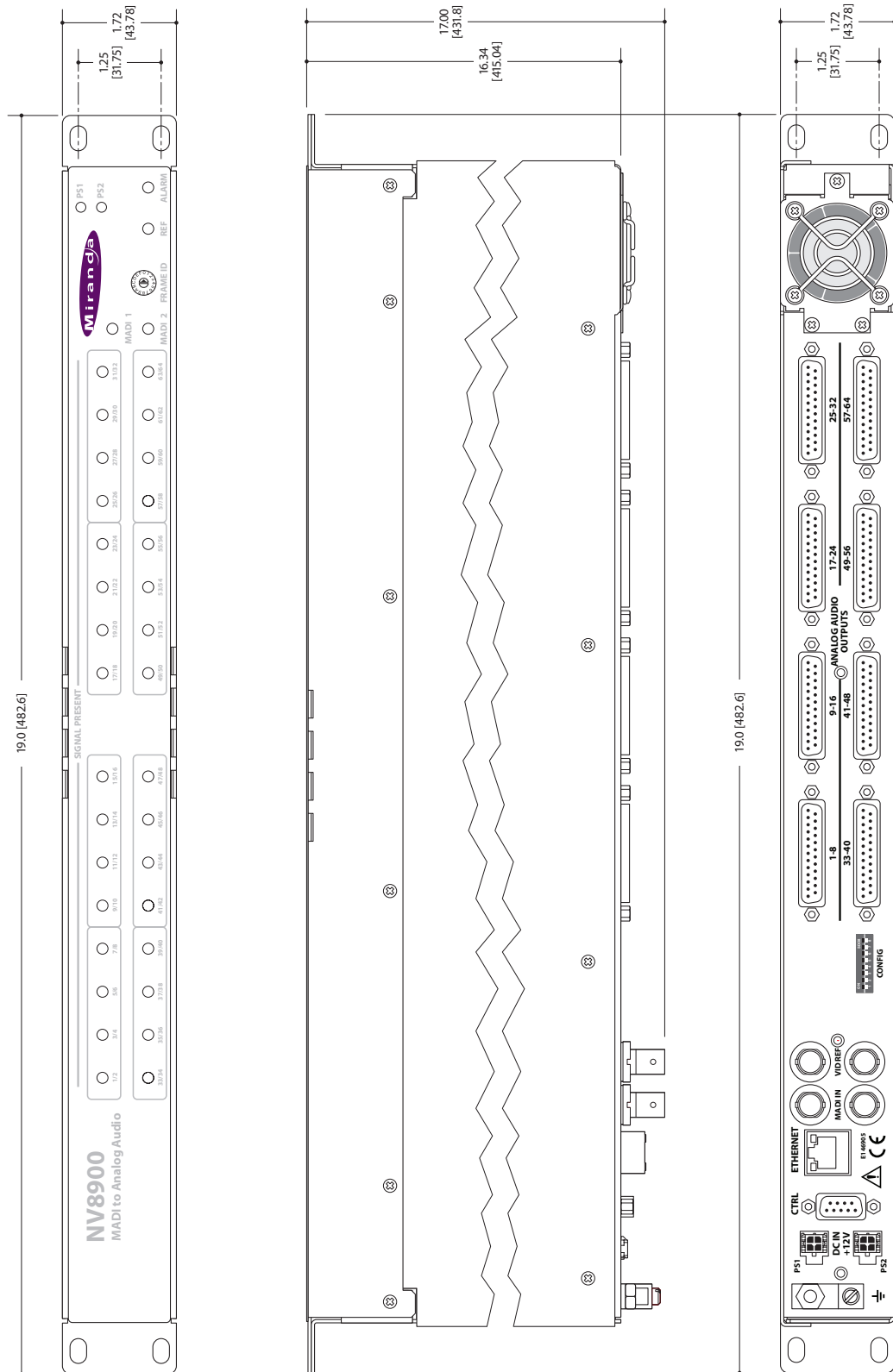

Fig. 4-6: Front, Top, and Rear Views of the MADI to Analog Audio Interface

Index

A

Abbreviations	2
Acrobat usage	1
bookmarks	1
hyperlinks	1
navigating and searching	1
Africa, contact	33
agreement, license	iii
Americas, contact	33
Analog	
audio specifications	19
Asia, contact	33
Audio	
specifications, analog	19
specifications, digital	18
Automation connector	19

B

Balanced AES to MADI mux	24
Balanced MADI to AES demux	22
BNC connectors	12
Bookmarks, Acrobat	1
Breakout cable, WC0053	12

C

Cable	
Ethernet	12
cautions	v
CE	ii
change history	ii
Channel numbering	13
Chapter structure	1
Chapters	
1, Preface	1, 3, 11, 15
China, contact	33
Coax AES to MADI mux	25–27
Coax MADI to AES demux	23
Compact router	11, 19
Configuration	4
Connectors	
automation	19
BNC	12

DB25	12
DE9	19
power	12
contact Miranda	33
Control panel	11
Conventions	2
corporate office, contact	33
CR Series	19
customer support	33

D

DB25 connectors	12
DE9 connectors	19
Declaration of Conformance	ii
Digital audio	
specifications	18
document	
notice of use	ii
part number	ii
revision	ii
Documentation	13
abbreviations	2
conventions	2
symbols	2
terms	2
Drawings	
balanced AES to MADI mux	24
balanced MADI to AES demux	22
coax AES to MADI mux	25–27
coax MADI to AES demux	23

E

Electrical specifications	
power supply	16
Electrostatic discharge	11
e-mail address	33
Environmental specifications	18
ESD	11
Ethernet	
cable	12
Europe, contact	33
Examples, symbol for	2

F

Fan 18
 fax number 33
 FCC statement ii
 Figures
 balanced AES to MADI mux 24
 balanced MADI to AES demux 22
 coax AES to MADI mux 25–27
 coax MADI to AES demux 23
 Find, Acrobat 1
 First Page, Acrobat 1
 France, contact 33
 Functions 4

G

General specifications, NV5500 17
 Go to Next View, Acrobat 1
 Go to Previous View, Acrobat 1
 Grounding terminal 12

H

hardware symbolsiv
 hazardous substance iii
 HD sync 16
 hours of operation 33
 How to
 install the router 11
 How to use this guide 1
 Hyperlinks, Acrobat 1

I

Inputs, connecting 12
 Installation
 NV9605 control panel 11
 package contents 11
 receiving and unpacking 11
 Installing a compact router 11

L

Last Page, Acrobat 1
 license iii

M

MADI
 specifications19
 Maintenance13
 Middle East, contact33
 Miranda, contact33

N

Next Page, Acrobat 1
 notice, use ii
 NTSC16
 NV5500
 general specifications17
 performance21
 NV9000
 system controller11
 NV9000-SE Utilities11
 NV915, system controller11
 NV960511

O

office hours33
 Operating temperature18
 Operation4

P

Package contents11
 PAL16
 Panels, control11
 part number, document ii
 PDF documents
 navigating and searching 1
 PDF file
 usage 1
 Performance, NV550021
 phone numbers33
 Photos
 power cord retention21
 Physical specifications
 analog video router17
 digital audio router17
 digital video routers17
 Power connectors12
 Power cord retention 11, 20
 Power specifications15
 power supply16
 Power supply 16, 20
 Previous Page, Acrobat 1

PS0001 (power supply) 16
PS1, PS2 12

R

Rack mount 11
Receiving and unpacking shipments 11
Reference video 12
 termination 12
restrictions iii
revision, document ii
RJ-45 12
RoHS iii
Rotary switch 11
Router
 inputs, connecting 12
RS-422 19
RS-485 19

S

safeguards iii
safety notices iii
Search, Acrobat 1
Software 13
 software license iii
Special messages, symbol for 2
Specifications
 analog audio 19
 digital audio 18
 environmental 18
 MADI 19
 performance 21
 physical, router 17
 power 15
 power supply 16
 video reference 16
Static 11
Strap, power cord retention 11, 20
support, contact 33
Switch, rotary 11
Symbols 2
 for examples 2
 for special messages 2

symbols, meaning iv
System controller
 NV9000 11
 NV915 11

T

Tables
 analog audio specifications 19
 digital audio specifications 18
 environmental specifications 18
 MADI specifications 19
 physical specifications, router 17
 power specifications, power supply 16
 video reference specifications 16
technical support 33
Temperature, operating 18
Termination
 video reference 12
trademarks iii

U

United Kingdom, contact 33
User's guide, chapter structure 1

V

Velcro strap 11, 20
Video
 reference 12
 reference, specifications 16
 reference, termination 12

W

warnings, hardware iv
warranty iii
WC0053 breakout cable 12
web site 33



Miranda Technical Support

For technical assistance, please contact the Miranda Technical Support center nearest you:

Americas

Office hours: 9:00 a.m. – 9:00 p.m. (EST)
Telephone: +1-800-224-7882
Fax: +1-514-335-1614
E-mail: techsupp@miranda.com

Asia

Office hours: 9:00 a.m. – 5:00 p.m. (GMT+8)
Telephone: +852-2539-6987
Fax: +852-2539-0804
E-mail: asiotech@miranda.com

Europe, Middle East, Africa, UK

Office hours: 9:00 a.m. – 6:00 p.m. (GMT)
Telephone: +44 118 952 3444
Fax: +44 118 952 3401
E-mail: eurotech@miranda.com

China

Telephone: +86-10-5873-1814
E-mail: asiotech@miranda.com

France

Office hours: 9:00 a.m. – 5:00 p.m. (GMT+1)
Telephone: +33 1 55 86 87 88
Fax: +33 1 55 86 00 29
E-mail: eurotech@miranda.com

Corporate Head Office

Miranda Technologies Inc.

3499 Douglas-B.-Floreani, St-Laurent, Quebec, Canada H4S 2C6

Telephone: 514-333-1772
Fax: 514-333-9828
Web: www.miranda.com



www.miranda.com