



NV960 Control System and Accessories

NV960 Product Summary

Your Grass Valley shipment contains an NV960 system controller, a rack-mounting rail kit, power cords, and this Quick Start guide. Depending on you order options, the shipment might also include cables and peripheral devices. See Figure 1.

An NV9000 router control system allows you to configure and operate routers, control panels, and other connected equipment. The NV9000 control system includes several parts that work together:

- NV960 system controller.
- NV9000-SE Utilities configuration software.
- PCs running configuration or control software.
- Routers.
- Control panels (physical or virtual).
- Optionally, master control components.
- Optionally, automation, UMD, and other subsystems.

System Controllers

The system controller is a device that (1) receives commands from control panel operators or from third-party systems, (2) dispatches instructions to routers, and (3) returns status information to the control panels or to automation. A system controller can be a stand-alone unit (an NV960). The NV965 comprises two controllers that are paired to make a redundant system. See *System Controller Redundancy* on page 2. (The NV967 is the same as the NV965 but adds an NV9700 panel and an EC9420 serial card.)

Located at the rear of the system controller are six Ethernet ports, two COM ports, and other ports. See Figure 2 on page 2. (Older NV960s had a slightly different set of ports. See Figure 4 on page 10.)

- *Control Net*
Provides communication between two system controllers being used as a redundant pair.
- *House Net*
Allows the system controller to communicate with your facility's computer network and with PCs running NV9000-SE Utilities, GUIs, and other software.
- *Panel and Router Nets 1 and 2*
Connect to routers and control panels. Any command initiated by an operator through a control panel is sent to the system controller, which interprets the command, and then sends appropriate instructions (such as "take") to the appropriate router(s).
- *NV9000 System Net*
Connects to other NV9000 systems.

Figure 1. Package Contents

One or Two System Controllers



(Front View)



(Rear View)



Rail Kit (s)



Power cords

QuickStart Guide (this document)

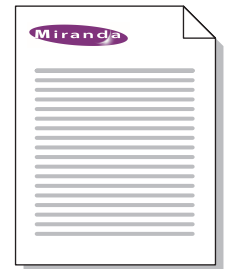

Optional Peripherals and Cables



- *Master Control Net*

Allows the system controller to communicate with a master control subsystem.

The front of the system controller features a removable perforated plate. Located behind the plate, in the middle and close together, are two LEDs and two small buttons. Each performs a function, as follows:

Location	Item	Function	Description
Leftmost	Blue LED	Warning	Lights when the system controller is not functioning properly.
Second from left	Blue LED	Power	Lights when power is on. An alarm sounds if redundant power is absent or degraded.
Second from right	Button	On	Press to turn the system controller on.
Rightmost	Button	Reset	Press to reset the system controller.

This QuickStart Guide

The purpose of this document is to guide you through the physical installation of the system controller, the installation of configuration software, and the initial setup of the software so that you can build configurations and read from and write to your system controller(s).

NV9000-SE Utilities is the primary tool for configuration.

NV9000-SE Utilities

NV9000-SE Utilities is software that is required for the configuration and management of the NV9000 control system. It is available on the SB0033 CD in this shipment.

After you have obtained NV9000-SE Utilities, you can install it on any PC. (NV9000-SE Utilities comes pre-loaded on the system controller.)

Control Panels

Control panels allow operators to setup and execute “takes” (routes) between source devices and destination devices.

Physical control panels are separate hardware units that connect to the system controller. *Virtual* control panels are software applications that emulate physical control panels and run on any PC (or Mac) connected to the system controller.

For more information on control panels, obtain the appropriate control panel user’s guide from the Grass Valley website or contact Grass Valley customer service for assistance.

Master Control

Master Control is a name given to an optional subsystem that allows operators to transition program output from one source to another with real-time effects such as cross-fades, keyer and logo overlays, squeezeback, and audio overs.

For more information, contact Grass Valley customer service or visit the Grass Valley website.

System Controller Redundancy

A redundant system comprises 2 system controllers connected together for reliability. If one system controller fails, the control system immediately switches to the other.

The two system controllers communicate with each other through their control network ports and their serial ports.

No other equipment should be connected to the ‘Control Net’ or to the serial port.

The active system controller is considered the *primary* controller. The other is the *secondary* (or *redundant* or *stand-by*) controller. The secondary controller queries the primary (active) system controller frequently through the control network. If the query and response mechanism fails, the secondary controller presumes that the primary controller is no longer functioning properly and takes over the role of primary controller.

Expansion Slot Options

The controller frame has a PCI expansion slot. Expansion options include:

- EC9412 A 10/100baseT PCI card that adds one Ethernet port.
- EC9414 A 10/100/1000baseT PCI card that adds two Ethernet ports.
- EC9420 An 8-port RS-232/422/485 PCI card with DE9 breakout box.
- EC9421 An external 1RU Ethernet-to-serial converter that has 16 RS-232/422/485 ports.
- EC9422 A serial “Y” cable for use with an EC9420 card in a redundant NV9000 system. One cable is required for each serial port.
- EC9423 An external 1RU Ethernet-to-serial converter that has 32 RS-232/422/485 ports.
- EC9424 A serial “Y” cable for use with an EC9421 or EC9423 converter in a redundant NV9000 system. One cable is required for each serial port.

Installation

Setting up the NV9000 control system requires several steps:

- Part 1 Mount the system controller in a rack and connect power.
- Part 2 Make physical network and I/O connections.
- Part 3 Install NV9000-SE Utilities software.
- Part 4 Perform initial setup of NV9000-SE Utilities.

Figure 2. System Controller (Rear View)

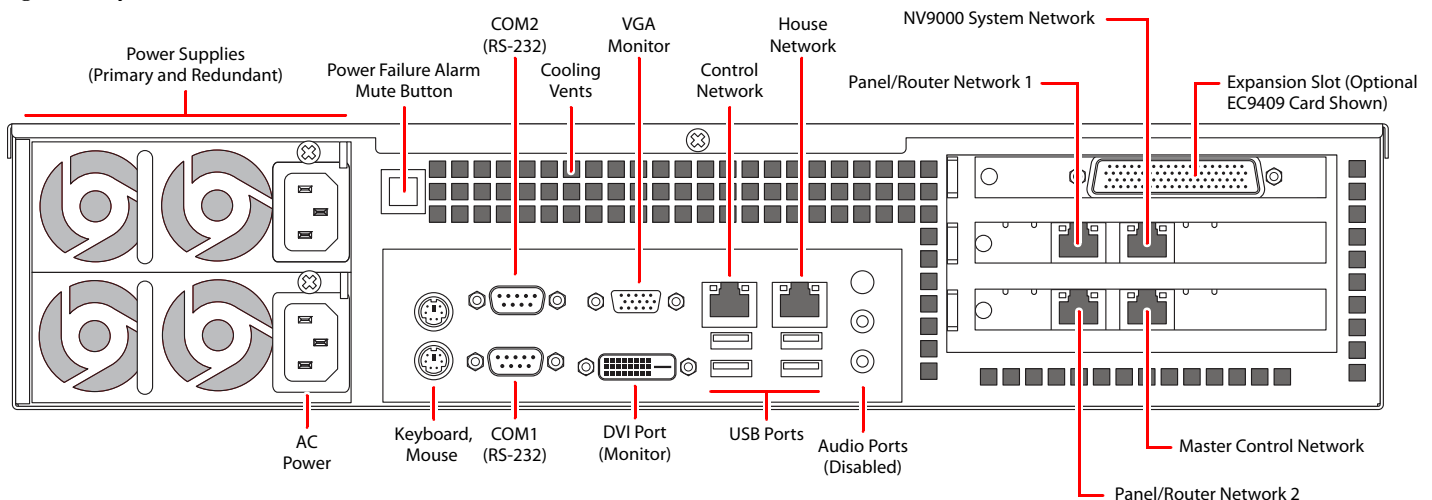

Networks require an Ethernet switch and CAT5 Ethernet cable. (The NVISION series' EC9415 — a 24-port Ethernet switch — is suitable.)

Part 1: Mount the Controller and Connect Power

The 2RU system controllers fit in a standard 19" (482.6 mm) rack. When placing the system controller in your facility, keep in mind that the controller needs a minimum of 6" (15 cm) of unrestricted air flow at the front and rear for cooling.

The NV960 occupies 2 rack units; the NV965 (two controllers) occupies 4 rack units. Each optional EC9413 breakout panel (RS-422) takes 1 RU if you install it in a rack.

Follow these steps to mount the controller(s):

1) Locate the packaged rail kit(s) and the system controller(s). Follow the directions in the rail kit package to install the rails in the rack. Then slide the system controller frame onto the rails. Repeat this step for the secondary controller if you have one.

2) Use the supplied power cords to connect power. The controller's power supplies accept 90–130/180–230 VAC, 50–60 Hz.

UL caution: *to reduce the risk of electric shock, plug each power supply cord into separate branch circuits employing separate service grounds. Redundant power connections, of course, provides additional protection against failure.*

3) Press the power button located on the front of the system controller. To access the button, turn the knurled screws and remove the perforated front plate on the system controller. It is the second button from the right.

If you disconnect power without first using the Windows 'Shutdown' command, you risk corrupting system data.

Part 2: Make Connections to the System Controller

The additional units that compose the NV9000 control system — PCs, control panels, routers — communicate through the system controller. The system controller uses Ethernet to connect to system components.

Each port has a unique IP address, fixed internally. The IP addresses depend on whether the system controller is stand-alone or redundant:

Port	Standalone Controller	Redundant Controller 1	Redundant Controller 2
Control net	172.16.1.1	172.16.1.1	172.16.1.2
Panel and router net 1	192.168.1.1	192.168.1.1	192.168.1.2
Panel and router net 2	192.168.2.1	192.168.2.1	192.168.2.2
House net	192.168.20.1	192.168.20.1	192.168.20.2
Master control net	192.168.7.201	192.168.7.201	192.168.7.202
NV9000 system net	192.168.3.1	192.168.3.1	192.168.3.2

- ▲ You may change the house net address to match your facility's house net.
- ▲ If your controller has an expansion slot card installed, it might have additional Ethernet ports or if slot has a serial card, your controller will have additional COM ports.
- ▲ The second panel and router network can be used for another purpose if you do not need it for panels or routers. The panel and router networks use DHCP.

Figure 3 (next page) diagrams a redundant system. If your system has a single system controller, please disregard the secondary controller and any connections to it.

Referring to Figure 3, follow these steps to make system controller connections:

1) Connect routers to the system controller.

Connect an Ethernet switch to either or both panel and router network ports on the primary controller. Do the same for the secondary controller if you have one.

A router might have both a primary and secondary control card for redundancy. Either or both may connect to the panel and router network.

For each router, connect the router's *primary* Ethernet port to the Ethernet switch on a panel and router network of the *primary* controller. If the router has a secondary control card, connect the *secondary* Ethernet port to the Ethernet switch on a panel and router network.

Note that the Ethernet switches are cross-connected in a redundant system:

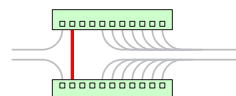

The cross-connection allows either controller to communicate with any panel and router network. In a non-redundant system, the cross-connection is not necessary.

A router's IP address(es) belong to its control card(s).

2) Connect physical control panels to the system controller. (Software control panels are treated separately.)

Connect an Ethernet switch to one of the panel and router network ports on the system controller.

Connect the Ethernet port on each of your control panels to the Ethernet switch.

Again, note that the Ethernet switches are cross-connected in a redundant system.

The NV9000 uses DHCP to assign a panel's IP address.

Each physical control panel must have a unique panel ID. You must set the panel IDs. The method is different for each physical panel. Refer to panel documentation or call Grass Valley customer support. (Note that a *panel ID* is not an IP address.)

Virtual control panels (a separately purchased option) can be installed on your PCs. Each virtual panel also has a

Figure 3. Connections in a Redundant System

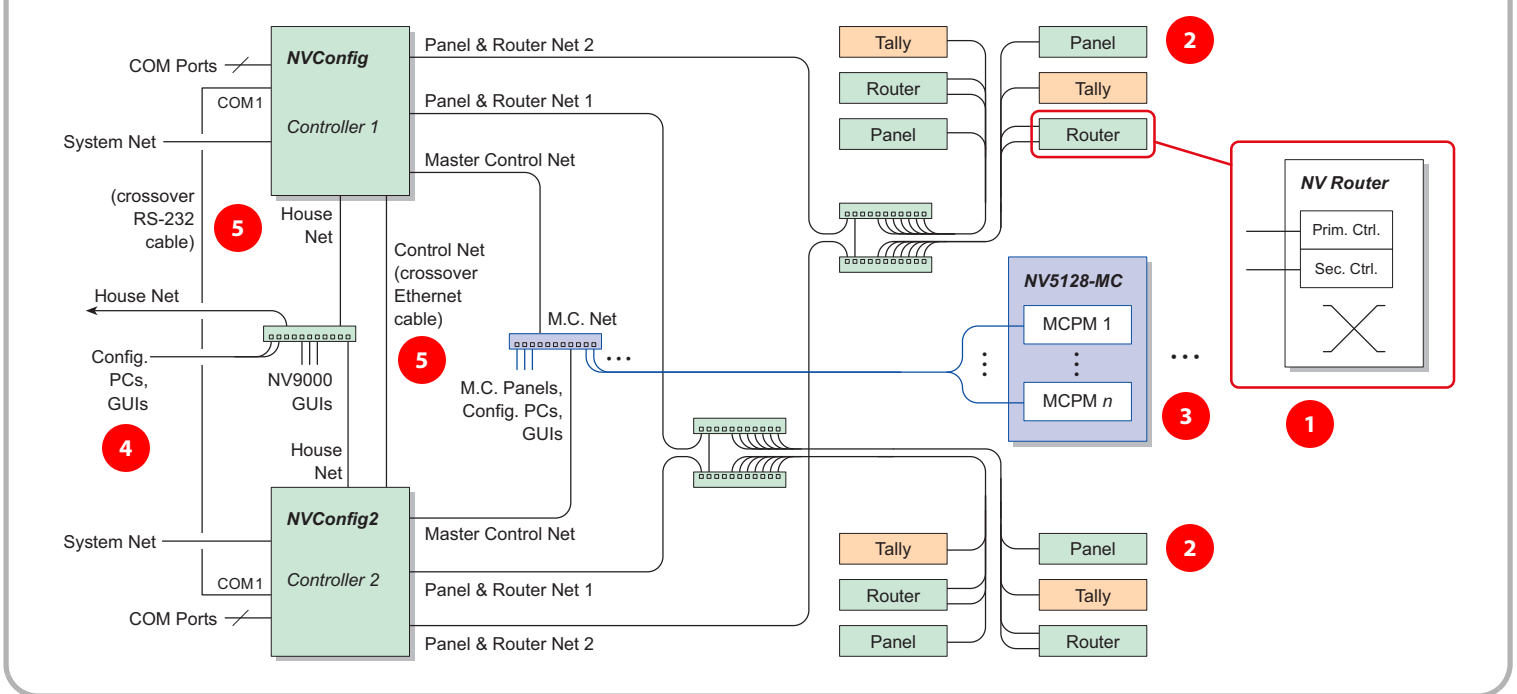

panel ID. The installation method is the same for all virtual panel types. Refer to the virtual panel documentation.

Panel IDs are important in the configuration software.

- 3) If your system includes a master control subsystem, connect the master control network port of the system controller to the Ethernet switch of the master control network.

(Each MCPM in the NV5128-MC frame connects to the master control network.)

This guide does not address master control planning and setup. Consult Grass Valley customer support or obtain master control documentation from the Grass Valley website if you need a master control system.

- 4) Connect one or more PCs to the system controller.

Each NV9000 user at your facility might wish to have a set of virtual panels, or to use the EC9700 or EC9710 GUIs. These software control panels allow remote or distributed control of the NV9000 system. One or more persons will use NV9000-SE Utilities to configure the system.

Regarding NV9000-SE Utilities, you have a choice:

- Install NV9000-SE Utilities directly on the system controller.
- Install NV9000-SE Utilities on one or more PCs connected to the system controller.
- Do both.

Connect any PCs you want connected to the controller to a switch on the 'House Net'. Set the PC's IP address to a fixed, unique value on the house network. The default

house network is 192.168.20.xxx with a subnet mask of 255.255.255.0. Use any value for xxx from 3 to 254.

- 5) If you have a redundant NV9000 system, make cross-connections between the two system controllers.

Connect the COM1 ports (DE9) on the two controllers using an RS-232 crossover cable. See Figure 2 for the location of COM1.

Connect the control net ports on the two controllers using an Ethernet crossover cable.

Part 3: Install NV9000-SE Utilities

NV9000-SE Utilities is a software application to create complete NV9000 configurations. It allows you to configure routers and control panels, and to perform system maintenance.

(A configuration must be uploaded to the system controller and the system controller must be restarted for the configuration to take effect.)

NV9000-SE Utilities can run directly on the system controller or it can run on any PC connected to the 'House Net' of the system controller.

NV9000-SE Utilities can also be used "offline" to create NV9000 configurations that you can transport and use at different locations.

Installing NV9000-SE Utilities on a PC

The PC on which NV9000-SE Utilities is installed must have the following:

- Windows XP Professional, Vista, or Windows 7.
- Late-model Pentium-class processor.

- 256 MB (or more) RAM.
- At least one 10/100baseT Ethernet port

Ensure that the PC's network connection has a fixed IP address on the system controller's house network. You do not need the network connection to install the software, or even to run the software, but you will need it to write configurations to the controller.

Installation Steps

Whether you are installing NV9000-SE Utilities on the system controller or on a PC, follow these steps:

- 1) Load the SB0033 CD in your PC's CD ROM drive. The CD will auto-play and you will see the following screen:



Click 'Configuration Software'. The next page appears:

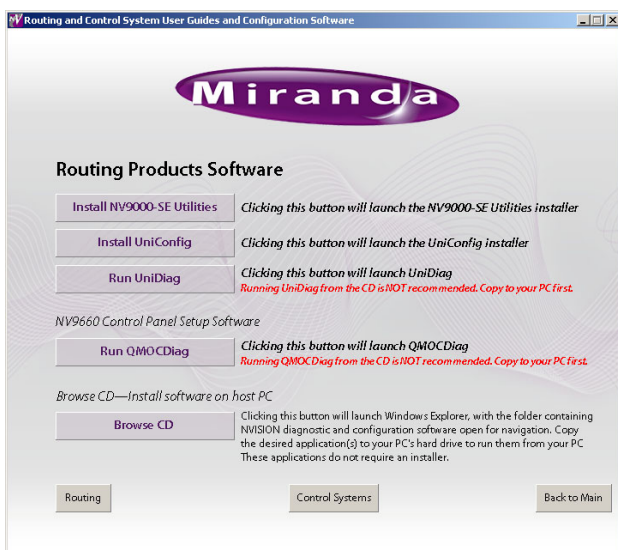

Click 'Install NV9000-SE Utilities' to launch the installer.

- 2) You can also copy the installer from the CD to your system's hard drive or a USB memory device and launch it from there. This is recommended if you are installing NV9000-SE Utilities on an NV9000 system controller that has no CD-ROM drive.

Double-click the copied installer to launch it.

- 3) When you launch the installer, the 'Welcome' screen appears after several seconds:

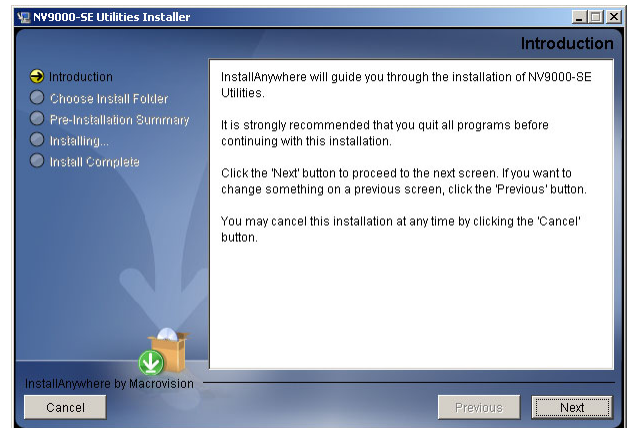

- 4) Click 'Next'. The 'Folder Location' screen appears:

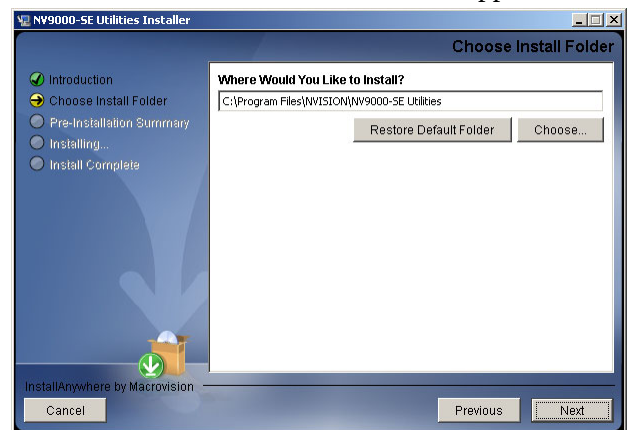

- 5) Click 'Next' to accept the default location.

Or

Click 'Choose' to open the 'Browse for Folder' window to browse to the folder you want. When you have selected a folder, click 'OK' to close the browse window, and then click 'Next'.

Or

Click 'Restore Default Folder' if you want to restore the default location, and then click 'Next'.

The 'Install' screen appears:

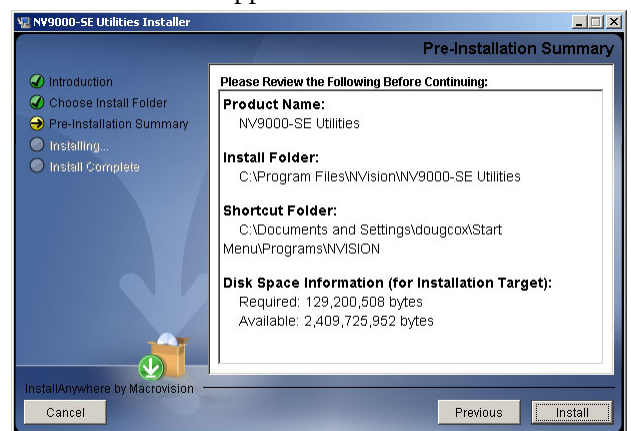

- 6) Click 'Install'. The installation then begins. It takes less than a minute.

NV9000-SE Utilities provides online help, which provides some orientation for new users and detailed information for experienced users.

An NV9000-SE Utilities user's guide (PDF) is available through Grass Valley customer support.

Part 4: Perform initial setup of NV9000-SE Utilities

You must set up NV9000-SE Utilities so it can write configurations to the system controller(s).

- ▲ We invite you to copy the sample configuration from the installation CD. It is instructive. You can also use the sample configuration as a starting point and modify it to represent the routers, control panels, and devices in your system.

- ▲ Operating

- ▲ on a PC should be no different from operating it on the controller.

After the initial configuration, you will be able to create panel configurations, define levels, identify device categories, and so on.

How to Set Up NV9000-SE Utilities

This discussion assumes that 'House Net' connection (if you require one) is working satisfactorily and that the controller is running. (Perhaps you have some routers and panels connected, but it is not necessary at this point.)

- 1) Launch NV9000-SE Utilities, either on your PC or on the system controller.

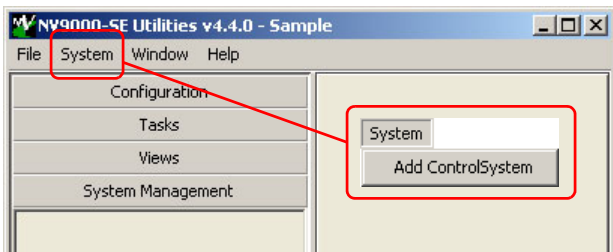

- 2) Click 'Add Control System' in the 'System' menu. The 'Add Control System' dialog appears. Enter a control system name. Enter the IP addresses of the primary controller. If there is a secondary controller, check the 'Redundant' box and enter the secondary IP address:

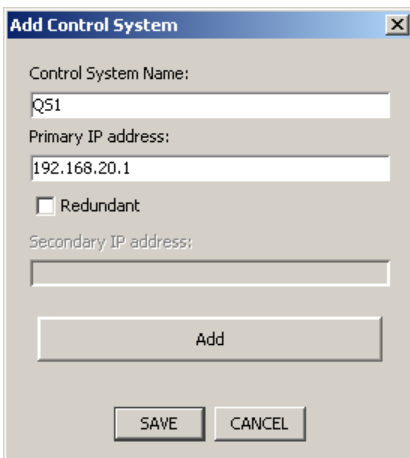

If you are logged into a PC, use the controller's house net address(es). If you are logged into a controller, use either the controller's house net or control net address(es). We suggest the control net address(es) in the latter case.

Then, click 'Add'. The dialog allows you to add more control systems. If you have others to add, you can do that now. Finally, click 'Save' to record your entry or entries.

A green icon should have appeared in the title of the 'System Management' pane. Click that title to open the System Manager pane:

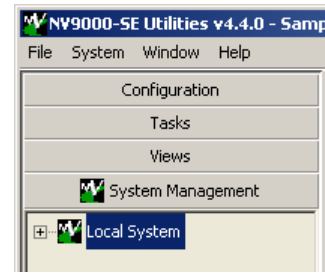

If a red icon appears, the control system you identified in step 2 is not connected, malfunctioning, or not properly specified.

It can take several seconds for NV9000-SE Utilities to discover the system state completely.

- 3) Load and restart the system with a new or updated configuration.

Be sure you have opened the configuration you want to become active in the controller. (The sample configuration available from the installation CD can be used.)

In the 'System Management' pane, click the icon of the system controller you want to configure. The system management page opens:

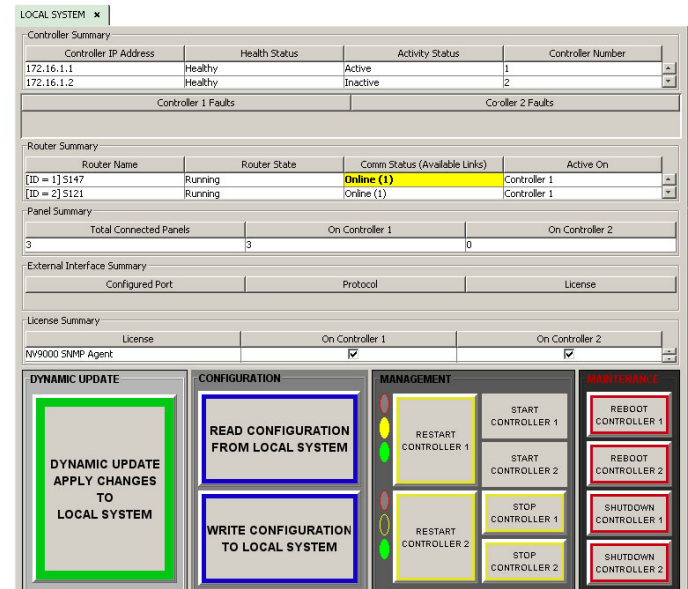

- ▲ The system controller icon must be green, otherwise the page does not open. Yellow icons represent system with warning-level errors. Red icons indicate severe errors or disconnected systems.

There are two remaining steps:

- Click 'Write configuration to *your system*'. Wait until the write completes. Progress indicators appear and then disappear.
- Click 'Restart Controller 1' to start the controller with the new configuration. It takes about 30 seconds. Wait until the restart completes.

If you have a redundant system, also click 'Restart Controller 2'.

As an alternative, you can click 'Dynamic Update Apply Changes to Local System'.

From this point onward, you can define (and refine) your NV9000 configurations and test them.

Sample Configuration

You can either use Grass Valley's sample configuration as a starting point or begin with a new (empty) configuration. When you begin to define a new configuration, we suggest you follow the order of the pages in the 'Configuration' pane. Refer to the User's Guide or on-line help for detailed information.

Follow these steps to obtain the sample configuration.

- 1) Load the SB0033 CD in your CD-ROM drive. The main screen appears:



Click 'Router Control System'. The next window appears:

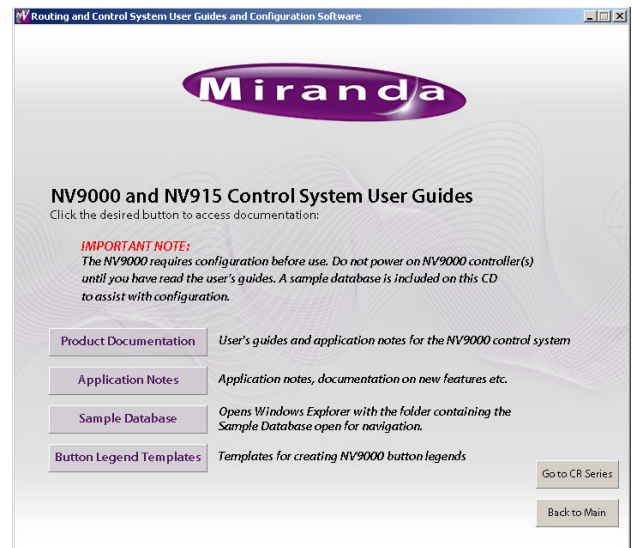

Click 'Sample Database'. The folder containing the database opens. It contains a .zip file that you should copy to your file system or a USB memory device.

- 2) Launch NV9000-SE Utilities. Choose 'Import from ZIP archive...' from the 'File' menu. Browse to select the .zip file. Click 'Open'. Give the configuration a name. SE takes a few seconds to save the configuration.

Follow these steps to load the configuration in a system controller:

- 3) In NV9000-SE Utilities, with the configuration open, go to the 'System Management' pane and click the controller's icon. (It must be green.) Then click 'Write configuration to *your system*' in the system management page.

Click 'Start' or 'Restart'.

- 4) After about 30 seconds, the controller should be running with the sample configuration.

The sample configuration has very little to do with the devices, routers, and panels in your system. You will not be able to operate your system until you load a configuration that represents your system.

However, you can perform tasks. To see this, click the SDI icon to open the SDI (router) page.

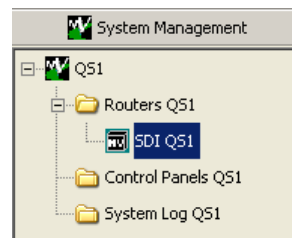

Choose an output and an input and click the ‘Take’ button. To lock an output, choose an output and click ‘Lock’

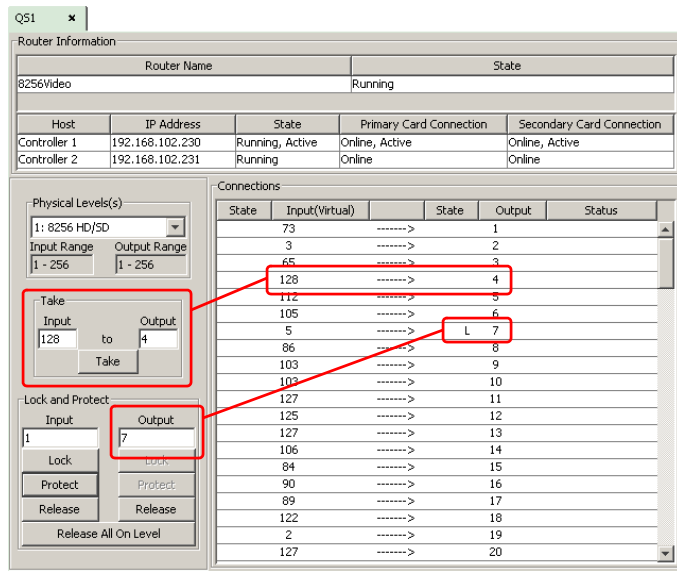

The take and the lock appear in the list. The lock appears as an ‘L’ next to the output.

Other Topics

Setting Your PC’s IP Address

Follow these steps to set the IP address of any PCs connected to the system controller:

- 1) Launch ‘Settings > Network Connection’ from your PC’s Start menu. The following window appears:

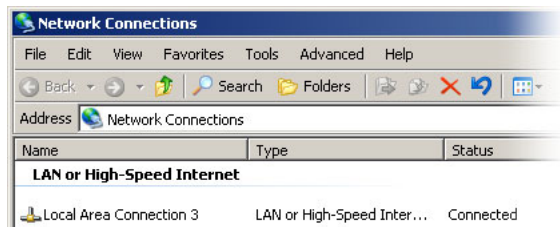

- 2) Double-click the appropriate ‘Local Area Connection’ for the controller’s house network. Then, choose the ‘General’ tab and click ‘Properties’.

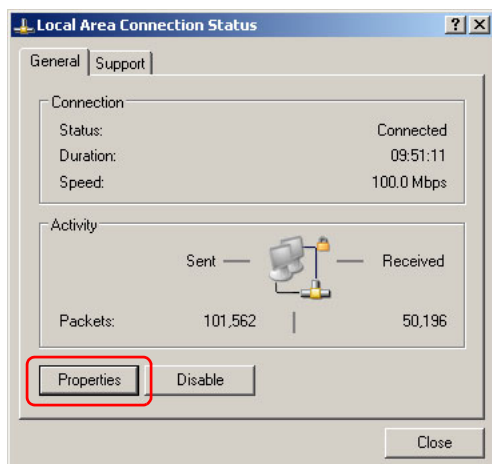

- 3) Select Internet Protocol (TCP/IP). Click ‘Properties’ again:

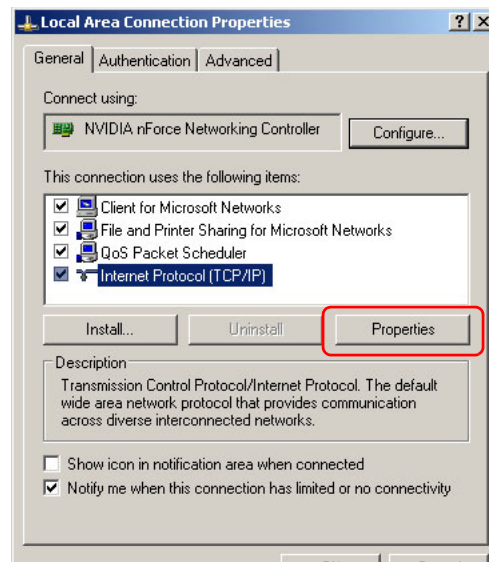

- 4) Select ‘Use the following IP address’ and enter an IP address for the PC:

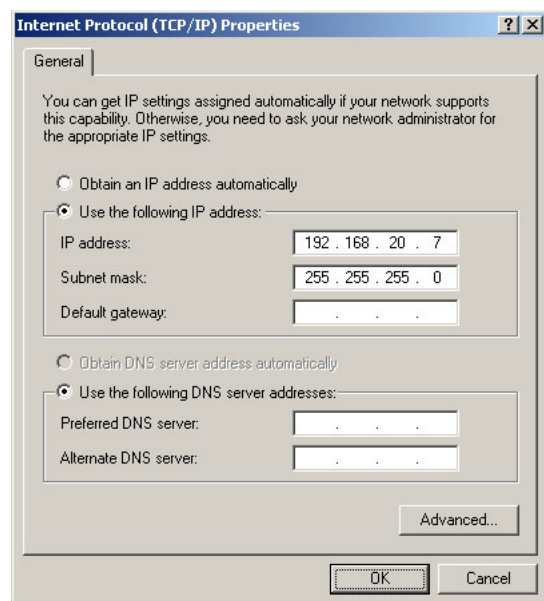

The IP address must be unique on the house network. (The subnet mask must be 255.255.255.0.)

- 5) Click OK and it is done. Close all the Network Connections windows.

Matching Your House Network

Adding your system controller to your facility’s ‘house’ network is the same as putting your PC on the house net:

- 1) Go into Windows ‘Network Connection’ on the controller and find ‘HOUSE NET’.
- 2) Give it an IP address (and mask) that is unique on your facility’s network. It should remain a fixed address.
- 3) Close all network configuration windows.

Installing NV9000 Tools on Your PC

The system controller comes with several useful applications that you can run if you are logged into the controller.

- EC9700 (Control GUI).
- Panel, GUI, and Salvo Editor (a.k.a. PGSE)
- EC9710 (Status GUI)
- System Manager
- Tieline Status GUI

You will probably want to copy these to some or all of your configuration and GUI PCs.

Follow these steps to distribute the tools:

- 1) From the system controller, copy

C:\nvision\envy\install\client\SV0269-04.msi
to the target PC.

▲ The released tools installer is SV0269-04, version F. However, it might be in that folder as Setup.exe.

- 2) Run the installer on the PC. (The installer takes you through several steps, asks a few questions, and in particular, asks for the address(es) of your controller(s):

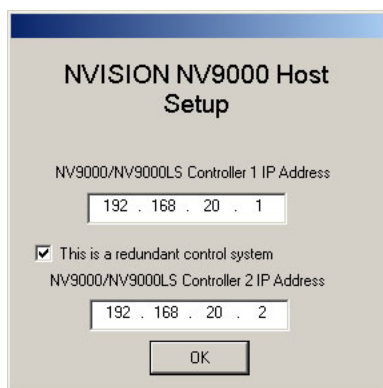

Enter the house net address(es) of the controller(s).

Some of these applications require setup or configuration in NV9000-SE Utilities. Read the associated manual (downloadable from the Grass Valley web site) or call Grass Valley tech support.

Misc. Advice

When you use the controller as a computer, you must login with user ID = *envyadmin* and password = *software*.

If you have only one power cord, you will hear a high-pitched beep when you turn on your controller. Press the red alarm mute button at the rear to stop the beeping.

When you turn off your controller, never just disconnect power. Always use the Windows shutdown command. Otherwise you risk corrupting system data. Also, use the redundant power cord. Using a UPS (uninterruptible power source) is also recommended.

The default pathname of NV9000-SE Utilities configuration storage is

C:\Documents and Settings*user*\CtrlSysConfigs
and does not exist until you first launch NV9000-SE Utilities.

The system controller has two built-in power supplies for redundancy. If power is interrupted, a power supply failure alarm sounds. This audible alarm does not cease until the power supply source is once again stable. To turn off the power supply alarm, press the red power supply alarm mute button located on the rear of the system controller, as shown in Figure 2.

Several NV9000 system controllers available are:

Code	Description
NV960	Single system controller
NV962	Adds redundancy to an NV960
NV965	Dual (redundant) system controllers
NV967	Dual system controllers with NV9700 panel and EC9420 serial card
NV920	Another NV9000 family system controller. See the <i>NV920 Quickstart Guide</i> .
NV915	Another NV9000 family system controller. See the <i>NV915 Quickstart Guide</i> .

Grass Valley offers several PCI expansion options:

Product	Description
EC9412	A 10/100baseT PCI card that adds one Ethernet port.
EC9414	A 10/100/1000baseT PCI card that adds two Ethernet ports.
EC9420	An 8-port RS-232/422/485 PCI card with DE9 breakout box.
EC9422	A serial "Y" cable for use with an EC9420 card in a redundant NV9000 system. One cable is required for each serial port.
EC9421	An external 1RU Ethernet-to-serial converter that has 16 RS-232/422/485 ports.
EC9423	An external 1RU Ethernet-to-serial converter that has 32 RS-232/422/485 ports.
EC9424	A serial "Y" cable for use with an EC9421 or EC9423 converter in a redundant NV9000 system. One cable is required for each serial port.

The executable files for the miscellaneous tools reside within C:\nvision\envy\bin:

Product	File Name
EC9700	EnvyApp.exe
PGSE	NV9000Cfg.exe [obsolete?]
EC9710	StatusGUI.exe
EC9790	Virtual control panels, Mac/Win.
System Manager	SystemManager.msc
Tieline Status	TielineStatusGUI.exe

NV960 Specifications

Spec	Data
Power	Auto-ranging, 90–130/180–250 VAC, 50–60Hz. 240 Watts.
Weight	29.8 lb (13.5 kg)
Size	2RU x 22 inches deep (56 cm)
Processor	Intel Pentium 4, 3.4 GHz
OS	Windows XP
RAM	3 GB
Disk	10 GB available for use; 250 GB total
Mouse port	PS2
Keyboard ports	PS2
Monitor port	VGA, HD15
Printer port	DB25 (parallel)
Serial port	DE9, RS-232
USB ports	4, high-speed
Ethernet ports	6, RJ-45, 10/100/1000baseT

Contact Information

Contact Grass Valley if you need information about NVISION router control systems or third-party automation systems.



In the Americas, call toll-free +1-800-224-7882 (9 am to 9 pm EST)

In Europe, the Middle East, Africa, or the UK, call +44 (0) 118 952 3444 (9 am to 6 pm, GMT)

In France, call +33 1 55 86 87 88 (9 am to 5 pm, GMT + 1)

In Asia, call +852-2539-6987 (9 am to 5 pm, GMT + 8)

In China, call +86-10-5873-1814

Find warranty, RMA notice, tech support, and other notices in the User's Guide. Specifications are subject to change without notice. © 2014 Belden, Inc. All Rights Reserved. NVISION is a registered trademark of Miranda Technologies, Inc. All other trademarks are the property of their respective owners.

Figure 4. Older System Controllers (Rear View)

