

# TRITON routing switcher

*Digital Audio Router 16x2 – 75 Ohm*

*Product model no. TTN-BES-1602/75*

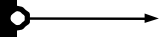

INSTALLATION MANUAL

MANUAL PART NO. 071-8225-00 Rev. 0  
FEBRUARY 28, 2003

*the most watched worldwide*

**Headquarters**

Thomson Broadcast Systems  
17 rue du Petit Albi - BP 8244  
95801 Cergy Pontoise Cedex  
FRANCE

Thomson Broadcast and  
Media Solutions, Inc.  
P.O. Box 599000  
Nevada City, CA 95959-7900  
USA

Copyright 2003 Thomson Broadcast and Media Solutions, Inc. All rights reserved. Grass Valley, Jupiter, and Triton are trademarks of Thomson. Specifications subject to change without notice.

For customer service, please call (800) 547-8949. For comments or questions concerning this manual, please contact: Technical Publications Department, P.O. Box 30816, Salt Lake City, Utah 84130 USA. Phone: (801) 972-8000. Fax: (801) 977-1602. Email: SLCTechpubs@THmulti.com

## *Contents*

<b>Electromagnetic Radiation Notice</b>	<b>v</b>
<b>Hardware Warranty and Software License</b>	<b>vi</b>
<b>Parts and Service</b>	<b>vi</b>
<b>Revision history</b>	<b>vii</b>
<b>1 General</b>	<b>1</b>
1.1 Specifications	1
1.2 Connection drawing	1
<b>2 Power connection</b>	<b>2</b>
<b>3 Connecting the BES-1602/75 to your PC</b>	<b>2</b>
3.1 Selection of router level	2
3.2 Pin-out of RS-232 connector	2
3.3 Maximum cable length	2
<b>4 NCB connection</b>	<b>3</b>
4.1 Several routers in one system	3
4.2 Connecting control panels	3
4.3 Pin-out and cable type	4
4.3.1 RJ45 connectors	4
4.3.2 5-pin DIN connectors	4
4.3.3 RJ45 to 5-pin DIN converter	5
4.4 Control bus structure	5
4.5 Maximum distance between NCB devices	5
4.6 Control Bus configuration notes	5
<b>5 Router configuration</b>	<b>7</b>
5.1 Router level	7
5.2 Router extension mode	8
<b>6 Connecting audio signals to the BES-1602/75</b>	<b>8</b>
<b>7 Input extension</b>	<b>9</b>
<b>8 Control and connection of Triton systems, interface protocol</b>	<b>10</b>
8.1 Important notes regarding the Triton Control Protocol	10
8.1.1 Binary Code	10
8.1.2 Echo	10
8.1.3 RS-422 Matrixes	10
8.1.4 Timeout	10
8.2 Basic principles	10
8.2.1 Example: A single unit with no NCB connected	10

8.2.2	Example: Several units connected by NCB	11
8.3	RS232	11
8.4	NCB	11
8.5	Commands	12
8.5.1	Audio crosspoint set	12
8.5.2	Audio crosspoint set acknowledge	12
8.5.3	Video crosspoint set	12
8.5.4	Video crosspoint set acknowledge	13
8.5.5	Crosspoint status request	13

## *Electromagnetic Radiation Notice*

The following information is given to note compliance with the United States Government Federal Communications Commission (FCC) Rules (47 CFR Part 15) designed to limit interference to radio and TV reception. The ruling establishes measurement procedures and frequency criteria for Class A computing devices (commercial and industrial applications) with the following conduction and radiation limits:

### *CLASS A COMPUTING DEVICE: CONDUCTION LIMIT (Part 15.812)*

<i>Frequency (MHz)</i>	<i>Maximum RF Line Voltage (uV)</i>
0.45 - 1.6	1000
1.6 - 30	3000

### *CLASS A COMPUTING DEVICE: RADIATION LIMIT (Section 15.810)*

<i>Frequency (MHz)</i>	<i>Distance (meters)</i>	<i>Field Strength (uV/m)</i>
30 - 88	30	30
88 - 216	30	50
216 - 1000	30	70

The policy of Thomson is one of continual development and improvement. For that reason Thomson uses components and manufacturing techniques that provide the current state-of-the-art suppression of electromagnetic radiation. This equipment, in production before October 1, 1981, has not been tested to the above listed measurements. However, equipment such as this delivered after October 1, 1983 will have the measurements on record at the factory. Therefore, in compliance with the stated FCC Regulation, the following information is provided for the user:

## **NOTE**

### *Interference to Radio Communications*

This equipment generates, uses, and can radiate radio frequency energy and if not installed and used in accordance with the instruction manual, may cause interference to radio communications. As temporarily permitted by regulation it has not been tested for compliance with the limits for Class A computing devices pursuant to Subpart J of of Part 15 of FCC Rules, which are designed to provide reasonable protection against such interference. **Operation of this equipment in a residential area is likely to cause interference** in which case the user at his own expense will be required to take whatever measures may be required to correct the interference.

## ***Hardware Warranty and Software License***

Please contact your local Thomson representative for hardware warranty and software license information.

## ***Parts and Service***

Thomson maintains a full stock of replacement parts available for immediate shipment.

### *NORTH AMERICA PARTS AND SERVICE*

Please call toll-free **1-800-547-8949**.

You will be switched automatically to the parts and service representative nearest you.

For email correspondence: [broadcast-support@thmulti.com](mailto:broadcast-support@thmulti.com)  
Internet: <http://www.thomsongrassvalley.com>

### *INTERNATIONAL PARTS AND SERVICE*

Contact your Thomson representative.

***Revision history***

Current revision of this document is the uppermost in the table below.

<b>Revision</b>	<b>Replaces</b>	<b>Date</b>	<b>Change Description</b>
0	-	28/02/03	Initial Revision





# 1 General

The BES-1602/75 is a 16x2 AES/EBU digital audio router with unbalanced 75 Ohm in- and outputs. This state of the art router provides high performance circuits in SMD technology for maximum system performance. The BES-1602/75 is designed for all demanding routing tasks in digital studio and broadcast environments. The BES-1602/75 offers the possibility to expand the router in the input direction up to 64x2. The built-in RS-232 interface allows the user to control the router via the Triton Router Control System PC software with many operational features. The control bus allows linking the unit to the BVS-1602 or BDS-1602 video router thus creating a 16x2 AFV router. Several units can be combined to form a 2 or more layer AES/EBU matrix system. One or several Triton remote control panels can control the BES-1602/75 as well.

## 1.1 Specifications

Signal type:	AES/EBU digital audio
Number of inputs:	16 unbalanced
Input impedance:	75 ohms
Number of outputs:	2 unbalanced
Output impedance:	75 ohms
Auxiliary outputs:	2 for router extension (75 Ohms impedance)
Jitter:	800ps
Signal level:	0.2 – 7Vpp
Sampling rates:	32 - 96 kHz
Switching mode:	digitally transparent
Audio connector:	DB25 female
AC power:	External power supply 100 - 260 VAC
DC power:	±5V, connector DB9 male
Dimensions:	483 x 44 x 45 mm (19", 1RU)

## 1.2 Connection drawing

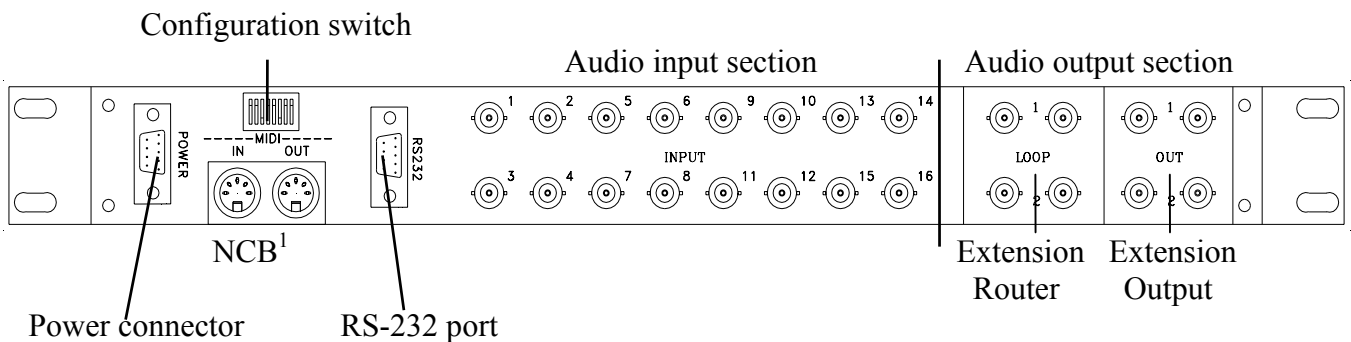

<sup>1</sup> Network Control Bus. The protocol of this bus is equal, and compatible to the MIDI bus protocol.

## 2 Power connection

**Do not connect mains to the desktop power supply before connecting the power supply to the router.**

Connect the DB9 female connector from the desktop power supply to the main unit. Tighten the screws to assure a proper contact. To connect mains to the desktop power supply you need a mains cord with IEC 320 connector.

The BES-1602/75 is normally delivered with the desktop power model **AC ±5V / 10W**. Upon customer request, BES-1602/75 can also be delivered with **DC ±5V / 30W**, which may be fed by a 36 – 72 VDC mains power source. A Frame mounted power supply solution is also available.

Please refer to the latest Triton Product Catalogue for power supply types, or call Thomson Grass Valley for this information.

If any third party power supply is used the BES-1602/75 router requires ±5V DC with a minimum current of 200mA. The following pin-out is used on the DB9 male power connector:

Pin 1	0V
Pin 2	+5V
Pin 6	-5V

## 3 Connecting the BES-1602/75 to your PC

For connection to a PC with Triton Router Control System, the RS-232 interface is used. The RS-232 port on all Triton devices uses the standard DCE pin-out, see pin-out table under 4.3.

A standard modem cable can be used for connecting the router to the PCs serial port.

### 3.1 Selection of router level

The router level depends on the system configuration the router is going to work with. See chapter 5 for more information. All routers are delivered with default level 1. Triton Router Control System offers the control of up to 16 different routers or combinations of routers.

### 3.2 Pin-out of RS-232 connector

The DB9 female connector for the RS-232 port has the following pin-out:

Pin 2	Tx
Pin 3	Rx
Pin 5	GND

### 3.3 Maximum cable length

The maximum cable length for an RS-232 connection is per definition 15m. Longer distances can be installed depending on the environmental conditions of the installation site. It is the responsibility of the installer / user to secure a proper installation of the RS-232 connection.

## 4 NCB connection

Via the Network Control Bus system several routers and control panels can be interconnected.

The standard MIDI interface is used on all NCB control ports. The BES-1602/75 router utilises 5-PIN DIN connectors for connecting to the NCB. This means that when you connect your BES-1602/75 router to other Triton devices, with RJ45 connectors, an RJ45 to 5-pin DIN interface is necessary.

*This converter can be ordered from Thomson Grass Valley.*

The NCB system allows connection of up to 16 routers with different levels on the same bus. Control panels dedicated to work with a specific router must be configured to the same level as the router. Several panels can work together with one specific router. Up to 16 single routers or combinations of routers can be controlled from the Triton Router Control System. The NCB system and all RS-232 ports interchange the system status.

### 4.1 Several routers in one system

The NCB system allows the interconnection of up to 16 routers with different levels in one system. A combination of routers working married counts as one level. This might for example be 1 audio router + 1 video router working as an audio follows video system or 3 video routers working as an RGB (YUV) system. The routers in such a constellation must be configured to the same level.

### 4.2 Connecting control panels

To get a control panel working with a specific router, configure the control panel to the same level as the router. Several panels can be configured to control the same router. The Triton panels can control 2 levels with breakaway function. If it is necessary to control more levels with breakaway an additional panel must be used. **Panels can also be connected to a router via the RS-232 interface. Please refer to your control panel manual for installation.**

### 4.3 Pin-out and cable type

#### 4.3.1 RJ45 connectors

On some Triton devices, the NCB cable can be connected to RJ-45 connectors. The following pin-out is used:

- Pin 1 = Not Connected
- Pin 2 = Not Connected
- Pin 3 = Not Connected
- Pin 4 = data
- Pin 5 = data
- Pin 6 = Not Connected
- Pin 7 = Not Connected
- Pin 8 = Not Connected

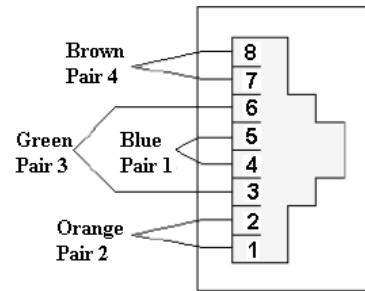

#### 4.3.2 5-pin DIN connectors

However, the pin-out of most Network Control Bus ports, including that of the BES-1602/75 follows the standard MIDI specification. A 1:1 cable with 5pin DIN connector is used. The following pin-out is used:

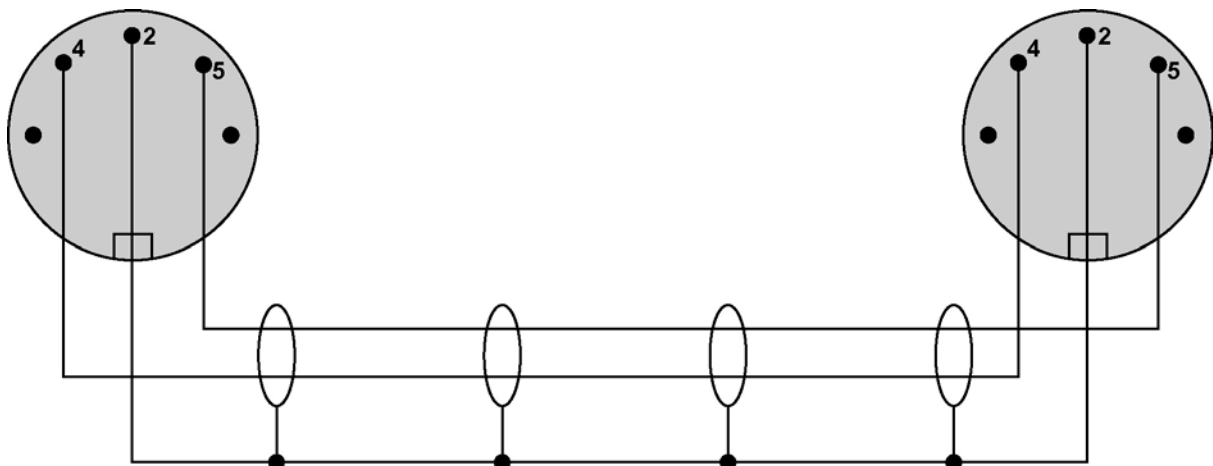

- Pin 1 = Not Connected
- Pin 2 = shield
- Pin 3 = Not Connected
- Pin 4 = data
- Pin 5 = data

The standard MIDI specification recommends the use of shielded twisted pair cable types for interconnection between the units.

### 4.3.3 RJ45 to 5-pin DIN converter

In configurations that include both devices with RJ45 connectors, and devices with 5-pin DIN connectors, an RJ45 to 5-pin DIN converter may be used to complete the control loop. This converter holds both connector types, and may work both ways, thus from RJ45 to 5-pin DIN, as well as from 5-pin DIN to RJ45.

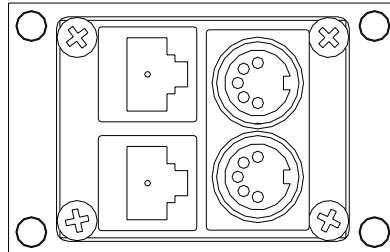

The converter is connected as follows:

RJ45 (Router/CP)	RJ45 (Converter)	5-pin DIN (Converter)	5-pin DIN (Router/CP)
IN	IN	IN	OUT
OUT	OUT	OUT	IN

### 4.4 Control bus structure

The Network Control Bus structure follows the standard MIDI bus definition. The NCB is defined as a closed chain of units. This means that the NCB OUT of the last unit must be connected to the NCB IN of the first unit in the NCB chain. To avoid problems with the control of Triton units the installer/user has to assure that the bus structure is installed according to this definition. The total number of Triton devices in an NCB chain is limited to 20.

### 4.5 Maximum distance between NCB devices

The standard MIDI definition allows a maximum cable length of 250 meters between two devices. Longer distances can be made with MIDI repeater units. To avoid grounding problems all NCB ports have opto-coupled inputs.

### 4.6 Control Bus configuration notes

In order to achieve a system that is easy to maintain and control, follow the important notes, presented hereunder.

- *Avoid using routers of different size, but same signal type (audio/video), on the same level.*  
 Example: Do not configure a system with a BVS-1616 and a BVS-0808 on the same level. If they were on the same level, crosspoint commands that were sent to the BVS-1616 lying outside the range of the BVS-0808 would not be executed; the BVS-0808 would throw them off the bus. However, a combination of a BVS-1616 and an BAS-0808 will work well, because commands are different for video- and audio routers.
- *Try to limit the number of devices on one Control Bus loop.* If possible, separate systems that are not to be controlled by one central control panel.  
 If you need to have several systems in one loop, try to separate as follows, using the DIP switches on the rear of the devices:
  - Analogue Video + Analogue Audio + CP for analogue system on Level 1
  - SDI + AES/EBU + CP for digital system on Level 2
  - RS-422 Data + CP for data on Level 3

- Universal Control Panel to control all devices above, with user configurable default level.
- Pay attention to the figure below, in order to achieve full controllability of all devices in the loop.

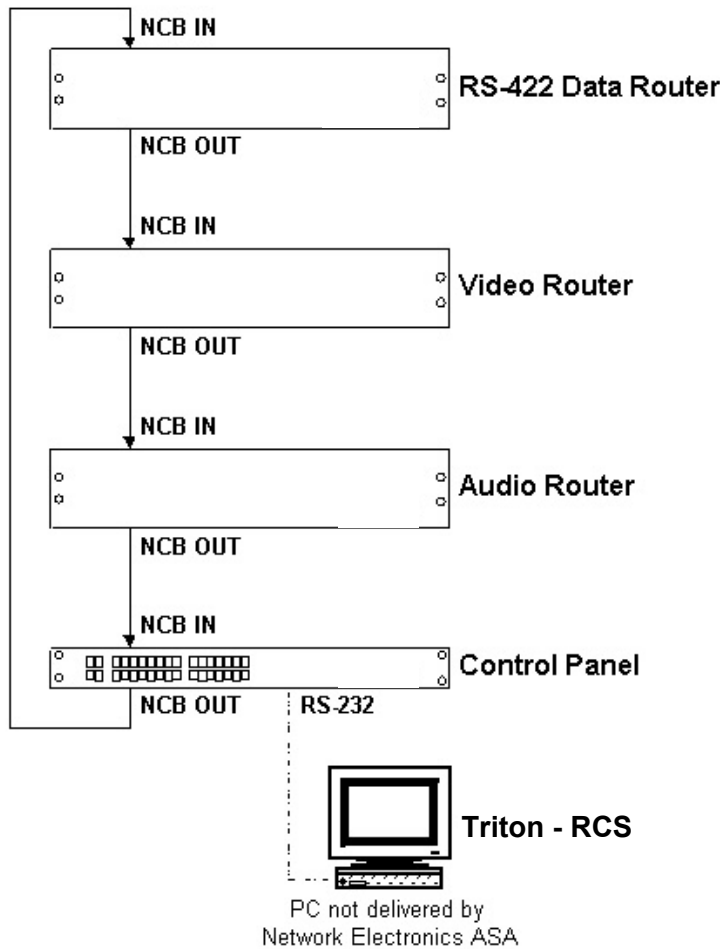

**Note!**  
The Video and Audio Routers may swap positions in the loop. However, they **MUST** be positioned **AFTER** the RS-422 Data Router. The Control Panels **must** be the **last** devices before closing the loop.

- *Complete the Control loop, by connecting all Control bus connections to all Triton devices, before powering up any Triton device.*

## 5 Router configuration

### 5.1 Router level

Switch 1 - 4 on the configuration switch set the router's level for communication with the Triton Router Control System, and other units in the NCB system. The panels on the NCB dedicated to operate with the router must be configured to the same level as that router.

If several routers are combined to form an audio follows video, RGB or similar system, these routers must be configured to the same level.

The levels can be switched according to the following pattern:

- means switch down
- \* means switch up

Default level is 1.

Switch	1	2	3	4	Level
	-	-	-	-	1
	-	-	-	*	2
	-	-	*	-	3
	-	-	*	*	4
	-	*	-	-	5
	-	*	-	*	6
	-	*	*	-	7
	-	*	*	*	8
*	-	-	-	-	9
*	-	-	-	*	10
*	-	-	*	-	11
*	-	-	*	*	12
*	*	*	-	-	13
*	*	*	-	*	14
*	*	*	*	-	15
*	*	*	*	*	16

## 5.2 Router extension mode

Switch 5, 6 and 7 on the configuration switch set the router's input offset in systems with 2 or more BES-1602/75. You can build systems up to 64x2. The chosen input offset defines on which input range each BES-1602/75 works on.

The offset can be switched according to the following pattern:

- means switch down
- \* means switch up

Switch	5	6	7	Offset
	-	-	-	0
	-	-	*	16
	-	*	-	32
	-	*	*	48

Switch 5 is always in position down.

Default is offset 0.

## 6 Connecting audio signals to the BES-1602/75

The BES-1602/75 router offers standard 75 ohms BNC connectors for in- and outputs. All inputs are terminated with 75 ohms.



### 7 Input extension

BES-1602/75 allows input extension up to 64x2. Please connect the routers as shown below. The router extension is done with standard BNC cable (75 Ohms). For connecting the device in the mid of a chain you use either a BNC T-connector or a split cable ( Y ). Both ends of a chain need to be terminated while the device in the mid of a chain needs to have high impedance. This is done with the DIP switch between the LOOP connectors. Position 75 means terminated with 75 Ohms. Position HI means not terminated high impedance.

Please refer to chapter 5.2 regarding input offset.

Term. switch or Plug

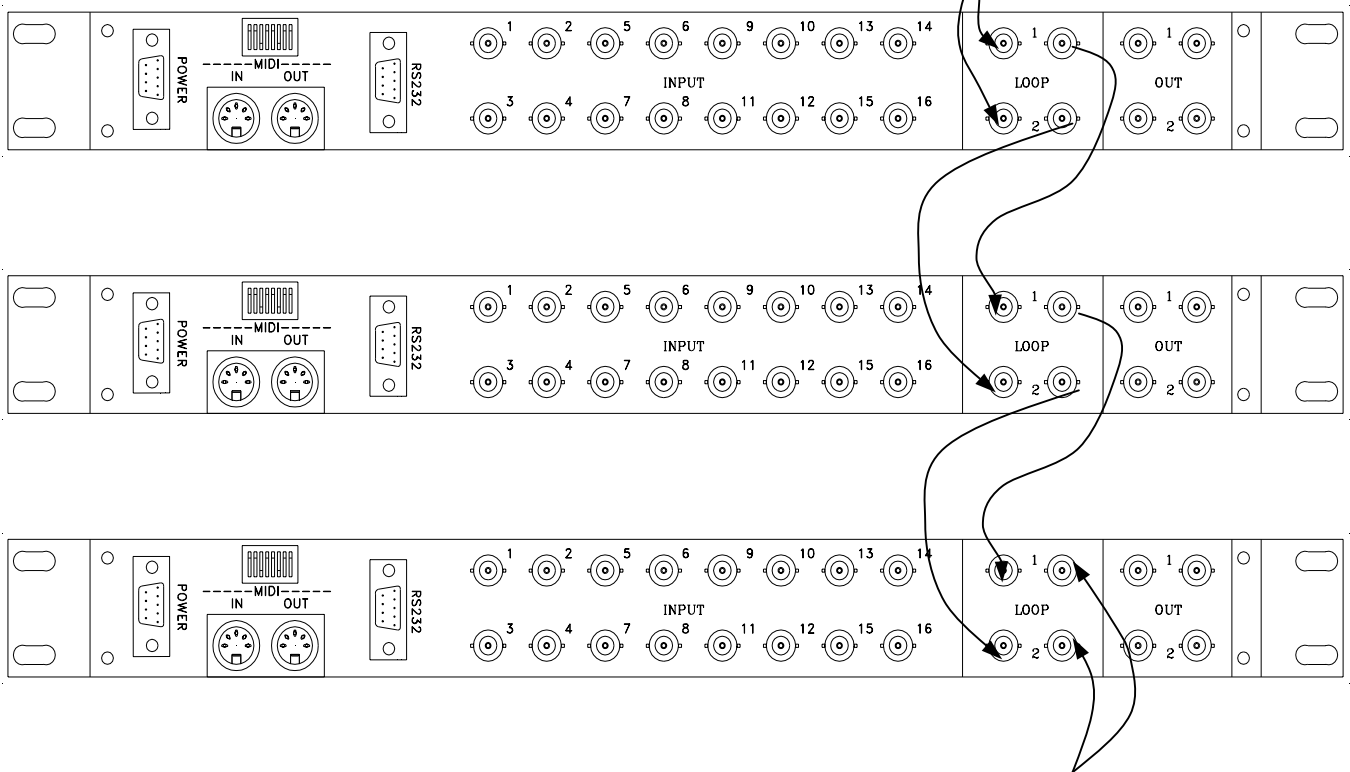

Term. switch or Plug

## **8 Control and connection of Triton systems, interface protocol**

### **8.1 Important notes regarding the Triton Control Protocol**

#### **8.1.1 Binary Code**

The strings shown on the next pages are in binary coded format. Please be aware of the fact that any terminal program you may use to control a Triton unit from a PC must be able to generate hexadecimal characters. ASCII characters will not be accepted.

#### **8.1.2 Echo**

A matrix will reply on a crosspoint set command with an ECHO. In the case where a crosspoint is already set no ECHO will be sent. If the matrix is part of an NCB system two types of reply will be sent. Immediately after receiving the crosspoint set command the ECHO will be sent. The matrix will then wait for the command to pass the NCB system. After receiving the command from the NCB system the matrix will send the command as an ACKNOWLEDGE.

#### **8.1.3 RS-422 Matrixes**

RS-422 Data Routers do not accept distribution of an input signal to several outputs. An input signal can only be routed to one single output. The Firmware of our RS-422 routers takes care of these limitations. If an input (Source) is already connected to a particular output (Destination) any connection of this input to another output would disconnect the previous connection. The router will in this case send the following message for the disconnected output: Output connected to input 128. Input 128 is an internal default for the disconnect status. Please see Triton recommendations for use of RS-422 data routers for further information.

#### **8.1.4 Timeout**

The Crosspoint Status Request message has a timeout, which means that you need to wait 1 second in between request messages.

### **8.2 Basic principles**

Any message on any level (address) that conforms to the standard arriving at either the NCB or the RS232 port will be re-sent on both NCB and RS232. The only exceptions are:

- a) A matrix that recognizes its address will not re-transmit the message if the crosspoint is already set.
- b) A matrix that recognizes its address will not re-transmit the message if the output number or input number exceeds its size.
- c) A unit (matrix or panel) will not re-transmit a message arriving at the NCB if it was re-transmitted a short while ago (typically 0.5 sec). This is done by grabbing a message storing it for the timeout period, and comparing it with new messages. After the timeout period the unit will grab a new message for compare. This is done to remove unwanted (read: unknown) messages from the NCB ring.
- d) A message arriving at the RS232 will always be re-transmitted unless it is a matrix, and one of the cases a) or b) is fulfilled.

#### **8.2.1 Example: A single unit with no NCB connected**

Messages sent to the RS232 of a single unit will be returned once no matter what address or input/output number the message has, unless it is a matrix which recognizes one of the conditions a) or b) above.

### 8.2.2 Example: Several units connected by NCB

Messages sent to the RS232 of a single unit will be returned once no matter what address or input/output number the message has, unless it is a matrix which recognizes one of the conditions a) or b) above.

If none of the cases a) or b) is fulfilled the message will also be transmitted on the NCB. Then if any unit on the NCB ring recognizes any of the cases a)/b) or c), the message will stop at that point. This means that the message will only be returned once on the RS232.

However, if none of the units on the NCB recognizes any of the cases a) to c), the message will return to the originator (the unit which received the message on RS232). This unit will re-transmit the message once more on both NCB and RS232. The message is therefore returned a second time on RS232. This time one of the cases a) or c) is sure to be identified by one of the units on the NCB, and the message is removed.

There is however one more special case: If several messages for unused addresses are transmitted with only little delay, one might experience that some messages are returned several times, as the store/compare/remove function in case c) can only handle a single message at the time. We therefore recommend that the user avoid sending messages to unused addresses.

### 8.3 RS232

The RS-232 port is used for external control of Triton units. The RS-232 port allows the customer to control the equipment via the Triton Router Control System PC program or self-defined customized solutions.

Connector for the RS-232 port is a DS9 female.

Pin 2 - Tx.

Pin 3 - Rx

Pin 5 - GND

A standard DCE (Data Communication Equipment) cable can be used for connection between PC and Triton equipment. The connection between the connectors is made one-to-one.

Data-rate is 19200 baud/sec with 8 data-bit, 1 stop-bit, no parity, if nothing else is specified in the user manual of the product.

### 8.4 NCB

The NCB is used for interconnection between several Triton units. Up to 20 routers and/or control panels can be linked together to form a routing system with many operational features.

The NCB utilises a 5 mA current loop with opto-coupled ports.

Standard connector is a 5pin DIN.

Standard MIDI cables can be used to interconnect several Triton units.

Data-rate is 31.25 Kbps.

1 start-bit, 8 data-bit, no parity, 1 stop-bit. Logical 0 = current ON.

## 8.5 Commands

### 8.5.1 Audio crosspoint set

Only for use with Audio routers.

Command for setting of crosspoints:

1001nnnn 0kkk kkkk 0vvv vvvv

- nnnn is the matrix address from 0 up to 15.
- kkk kkkk is the output which shall be controlled.  
kkk kkkk = output number  
0 = output 1  
127 = output 128
- vvv vvvv is the input which shall be connected to the chosen output.  
vvv vvvv = input number

### 8.5.2 Audio crosspoint set acknowledge

Only for use with Audio routers.

Command for acknowledging setting of crosspoints:

1000nnnn 0kkk kkkk 0vvv vvvv

- nnnn is the matrix address from 0 up to 15.
- kkk kkkk is the output which shall be controlled.  
kkk kkkk = output number  
0 = output 1  
127 = output 128
- vvv vvvv is the input which shall be connected to the chosen output.  
vvv vvvv = input number

### 8.5.3 Video crosspoint set

Only for use with Video routers.

Command for setting of crosspoints:

1010nnnn 0kkkkkkk 0vvvvvvv

- nnnn is the matrix address from 0 up to 15.
- kkk kkkk is the output which shall be controlled.  
kkk kkkk = output number  
0 = output 1  
127 = output 128
- vvv vvvv is the input which shall be connected to the chosen output.  
vvv vvvv = input number.

#### 8.5.4 Video crosspoint set acknowledge

Only for use with Video routers.

Command for acknowledging setting of crosspoints:

1011nnnn 0kkkkkkk 0vvvvvvv

- nnnn is the matrix address from 0 up to 15.
- kkk kkkk is the output which shall be controlled.  
     kkk kkkk = output number  
     0 = output 1  
     127 = output 128
- vvv vvvv is the input which shall be connected to the chosen output.  
     vvv vvvv = input number.

#### 8.5.5 Crosspoint status request

This command is used for status request on Audio and Video routers.

1100nnnn 0xxxxxxx

- nnnn is the matrix address from 0 up to 15.
- xxxxxxxx - do not carry any information

The requested router (Audio or Video) will send its crosspoint status on NCB OUT and RS232. The same command format as for crosspoint set is used.